

Differential Pressure Flow Sensors

V200 Screw Drive Threaded Components

The Most Accurate and Reliable Technology for Measuring Gas, Liquid and Steam...

Developed from aerospace technology, the Verabar® averaging pitot flow sensor provides unsurpassed accuracy and reliability. With its solid, one-piece construction and bullet shape, the Verabar makes flow measurement leak proof and precise.

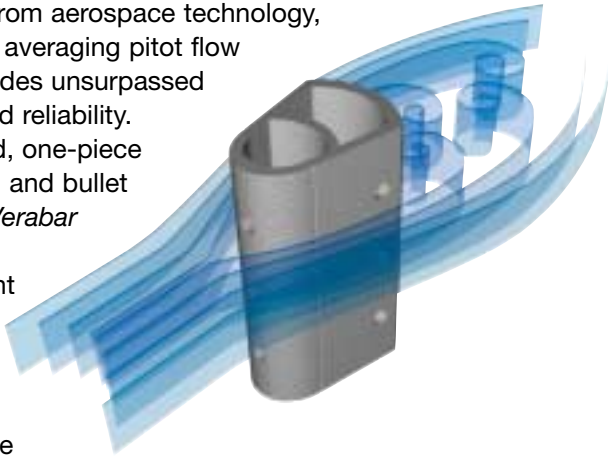

The unique sensor shape reduces drag and flow induced vibration. The location of the low-pressure ports eliminates the potential for clogging and improves signal stability.

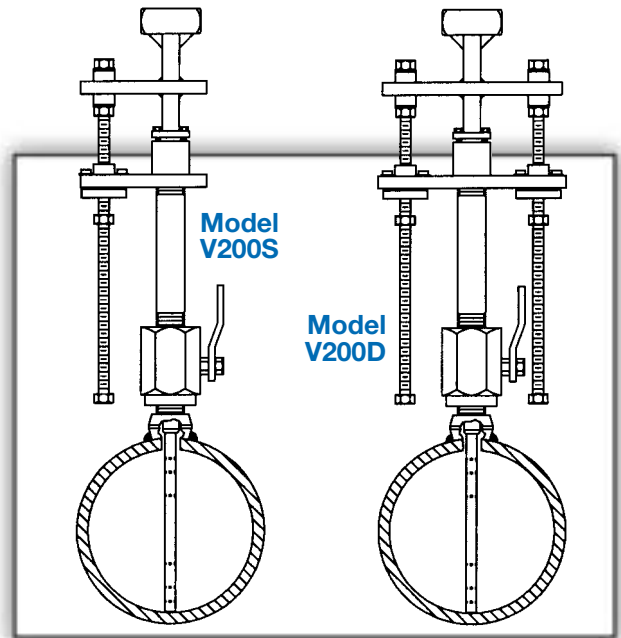

V200 Hot Tap	
Pipe Connection	Threaded (NPT)
Mounting Type	Ball or gate access valve
Features and Benefits	<ul style="list-style-type: none"> • Most commonly used hot tap model • Installation, insertion & retraction without system shutdown • Economical single threaded rod for most applications • Two threaded rods for high pressures • Synchro drive simultaneously rotates both rods (double rod drives only) • Patented, anti-seize orbital bearing aligns threaded rods and eliminates galling • Can mount to existing valves
Applications	<ul style="list-style-type: none"> • Air (compressed, combustion) • Natural gas • Water (raw, cooling, feedwater) • Steam
Special Designs—Consult Factory	<ul style="list-style-type: none"> • Custom mounting, lengths, materials, instrument connections, etc. • Short straight run

Temperature Pressure Limits (ANSI Class Rating)
150#
275 psig @ 100°F (19 Bars @ 38°C)
80 psig @ 800°F (5.5 Bars @ 426°C)
600#
1440 psig @ 100°F (99.3 Bars @ 38°C)
660 psig @ 800°F (45.5 Bars @ 426°C)

Model Specifications	V200S			V200D	
	05	10	15	10	15
Sensor Code	05	10	15	10	15
Sensor Diameter	7/16" (11mm)	7/8" (22mm)	1-3/8" (35mm)	7/8" (22mm)	1-3/8" (35mm)
ANSI Class	600#	150#	150#	600#	600#
Drive Rods	Single			Double	
Pipe Size	2"-6" (50mm-150mm)	6"-42" (150mm-1050mm)	12"-60" (300mm-1500mm)	6"-42" (150mm-1050mm)	12"-60" (300mm-1500mm)
Instrument Connection	1/2" NPT	1/2" NPT or Direct Mount		1/2" NPT or Direct Mount	
Components Furnished	Weld coupling, close nipple, access nipple and valve				
Weld Coupling Size	3/4" NPT	1-1/4" NPT	2" NPT	1-1/4" NPT	2" NPT

Verabar® Hot Tap Models

V200S (Single Rod) V200D (Double Rod)

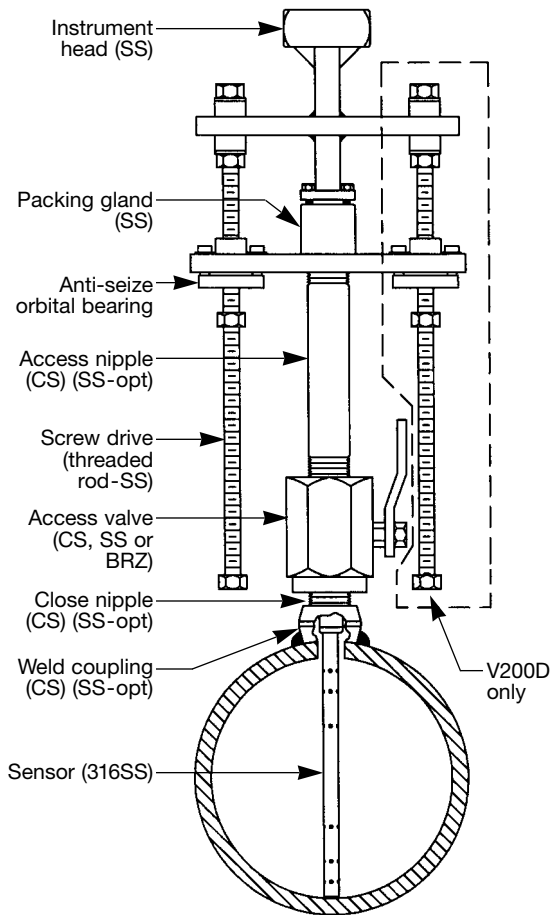

Synchro-Drive (Option SYN)

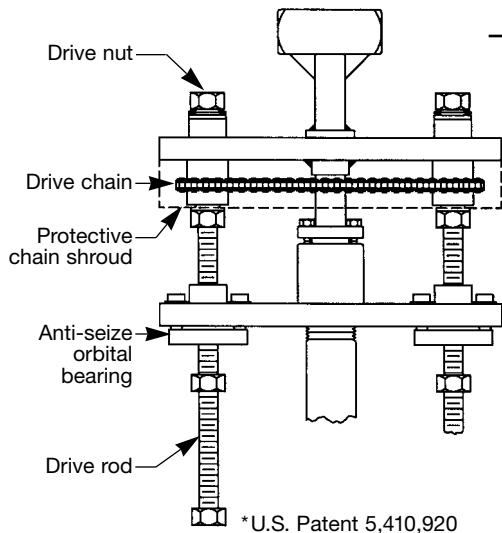

Furnish the following information:

1. Enter Pipe Dimensions or Duct Dimensions

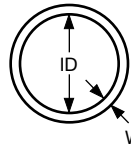

Pipe Size ____ Sch ____
Pipe ID ____ and
Wall ____ Pipe Mat'l ____

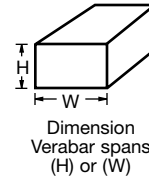

Height (H) ____
Width (W) ____
Wall ____
Duct Mat'l ____

2. Pipe or Duct Orientation

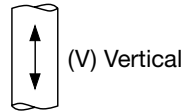
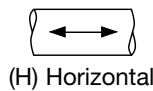

3. Enter Flow Conditions

Fluid Name:		Maximum	Normal	Minimum	Units
Flow Rate					
All Fluids	Temperature @ Flow				
	Pressure @ Flow				
Gas	Specific Gravity, or Molecular Weight				
Liquid	Specific Gravity				
Steam	Veracalc Program can calculate Density from Temperature and Pressure				

4. Select Model from page 3.

Use the Ordering Information table on page 3 to determine your model number.

5. Flow Calculation



All Verabar applications require a flow calculation to verify the DP, pressure and temperature limits, structural limits and to size the transmitter. The Veracalc PC Program is for use by representatives and end users. It is easy to operate and **includes steam tables**.













Synchro-Drive Description

- Designed for pressures greater than ANSI Class 150#, Synchro-Drive is equipped with two drive rods that are coupled together by a protected chain drive system. Turning either drive nut simultaneously rotates both rods.

Synchro-Drive Benefits

- 95% faster and easier insertion and retraction.
- Equal load distribution over both rods maintains sensor alignment and eliminates binding.

Ordering Information

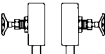
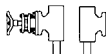
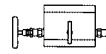
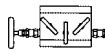
Model	Hot Tap • Threaded Pipe Connections and Components						
V200S	Single Rod, Insert/Retract, General Purpose (05 Class 600, 10 and 15 Class 150)						
V200D	Double Rod, Insert/Retract, Higher Pressures (600# max.) (10 and 15 only)						
Pipe Size and Schedule or Exact ID and Wall Thickness							
	Code	Sensor Pipe Size Range					
	05	2" to 6" (50mm to 150mm)					
	10	6" to 42" (150mm to 1050mm)					
	15	12" to 60" (300mm to 1500mm)					
	Code	Pipe Orientation					
	H	Horizontal					
	V	Vertical					
Instrument Connections (Select Remote or Direct Mount) (Transmitter sold separately; see Field Flow Systems literature)							
 Remote Mount Transmitter (1/2" NPT)				 Direct Mount Transmitter (Flanged 250°F/120°C Max.)			
Parallel	Regular	RTD*	Valve	Transmount	Mass Transmount*	Manifold	
		 Explsn. Proof	 Integral		 Integral RTD	 Remote RTD	 Integral
P	R	D	T	F	G	E	M
Instrument Valves (Opt.)				Manifolds (Optional)			
 Remote Mount				 Direct Mount			
Needle		Gate		3-Valve		5-Valve	
							
1/2" NPT		1/2" NPT		Soft Seat Hard Seat		Soft Seat Hard Seat	
C2NC (CS) C2NS (SS)	C2GC (CS) C2GS (SS)	F3SC (CS) F3SS (SS)	F3HC (CS) F3HS (SS)	F5SC (CS) F5SS (SS)	F5HC (CS) F5HS (SS)		
Mounting Assembly — Select Valve Type & Material (Includes valve, close nipple & weld coupling)							
Sensor (Valve Size NPT)						Type, Material & Rating	
05 (3/4")	10 (1-1/4")	15 (2")					
Code							
B3B	B5B	B8B	Ball, Brz., 600 psig @ 100°F, 100 psig @ 400°F (max.)				
B3C	B5C	B8C	Ball, CS, 1000 psig @ 100°F, 100 psig @ 400°F (max.)				
B3S	B5S	B8S	Ball, SS, 1000 psig @ 100°F, 100 psig @ 400°F (max.)				
G3C G3S	G5C G5S	G8C G8S	Gate, CS, ANSI Class 600# Gate, SS, 1200 psig @ 100°F, 660 psig @ 800°F				
Code Options							
SYN		Synchronized Two Rod Drive System (Available for V200D-10 and V200D-15 sensors only)					
WPS		SS Wetted Components (Furnished with SS weld coupling, close & access nipple). Must be ordered with SS access valve.					
V200D 8"sch40	10	H	R	C2NC	B5C	SYN	Typical Model Number

* For high pressure (>500psig) and high temperature (>500°F) remote mount RTD in a thermowell is preferred.

PARALLEL	REGULAR	RTD	VALVE	NEEDLE	GATE
1/2" NPT	1/2" NPT	X PROOF	INTEGRAL	1/2" NPT	1/2" NPT
CODE P	CODE R	CODE D	CODE T	CODE S	CODE G
DM	TRANSMOUNT	MASS TRANSMOUNT	MANIFOLD	3-VALVES	5-VALVES
MON	INT RTD	RMT RTD	INTEGRAL	SOFT SEAT	SOFT SEAT
UMENT	CODE F	CODE G	CODE M	HARD SEAT	HARD SEAT
CODE	CODE F	CODE G	CODE M	F33C (GS)	F53C (GS)
				F33S (SS)	F53S (SS)

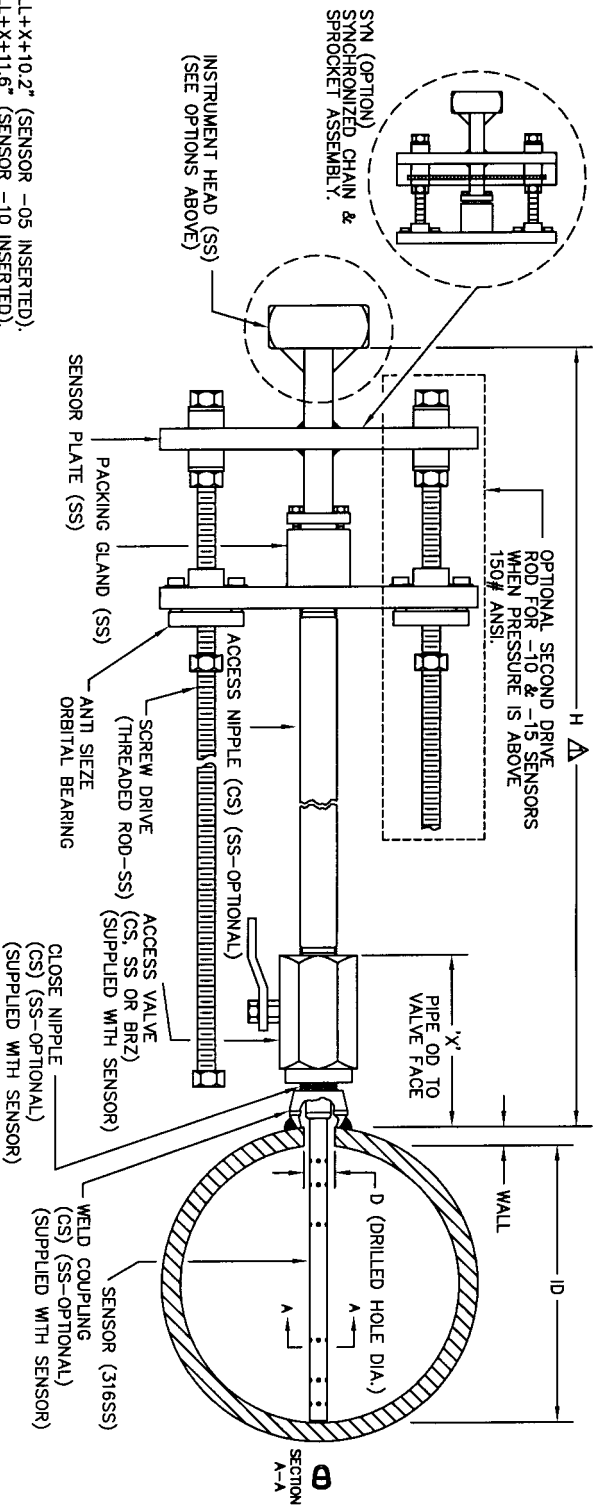

- NOTES:
- △ H=ID+WALL+X+10.2" (SENSOR -05 INSERTED).
 - H=ID+WALL+X+11.6" (SENSOR -10 INSERTED).
 - H=ID+WALL+X+13.6" (SENSOR -15 INSERTED).
 - H=2(ID+WALL+X)+10.1" (SENSOR -05 RETRACTED).
 - H=2(ID+WALL+X)+11.4" (SENSOR -10 RETRACTED).
 - H=2(ID+WALL+X)+13.3" (SENSOR -15 RETRACTED).
 - ADD 1.5" TO 'H' FOR -10 SYNCHRO DRIVE.
 - ADD 1.75" TO 'H' FOR -15 SYNCHRO DRIVE.
2. INSTRUMENT HEAD AND ACCESS VALVE ORIENTATION FOR SHOWN 90 DEGREES FROM ACTUAL ORIENTATION FOR CLARITY.

ITEM	SENSOR -05	SENSOR -10	SENSOR -15	PRESSURE RATING
SENSOR DIA.	7/16" (11mm)	7/8" (22mm)	1-3/8" (35mm)	-
COUPLING SIZE	3/4" NPT	1-1/4" NPT	2" NPT	-
DIM 'D' DRILLED HOLE DIAMETER	1/2" (13mm)	1" (26mm)	1-1/2" (39mm)	-
DIM 'X' FOR BRONZE BALL VALVE	5.6" (142mm)	7.2" (183mm)	8.4" (213mm)	600PSI ● 100F/100PSI ● 400F
DIM 'X*' FOR CS BALL VALVE	6.2" (157mm)	7.6" (193mm)	9.1" (231mm)	1000PSI ● 100F/100PSI ● 400F
DIM 'X** FOR SS BALL VALVE	6.0" (152mm)	7.7" (196mm)	9.1" (231mm)	1000PSI ● 100F/100PSI ● 400F
DIM 'X*** FOR CS GATE VALVE	6.5" (165mm)	7.7" (196mm)	10.1" (257mm)	ANSI CLASS 600#
DIM 'X**** FOR SS GATE VALVE	6.0" (152mm)	7.7" (196mm)	8.8" (224mm)	1200PSI ● 100F/650PSI ● 800F

* 'H' & 'X' DIMENSIONS ARE APPROXIMATE (FOR SIZING PURPOSES ONLY).

CUSTOMER: _____

PROJECT: _____

ORDER NO: _____

TAG NO: _____

PIPE SIZE & SCHEDULE: _____

CATALOG NO: _____

SERIAL NO: _____

CERTIFIED BY: _____ DATE: _____

VERIS, inc.

6315 MONARCH PARK PLACE
 NIWOT, CO 80503
 PHONE: 303-652-8550
 FAX: 303-652-8552

VERABAR MODEL: V200 SINGLE & DOUBLE ROD THREADED

DATE 09/20/01 DWG NO. SUB-3936

SCALE NTS REV A PAGE 1 OF 1