

# 1

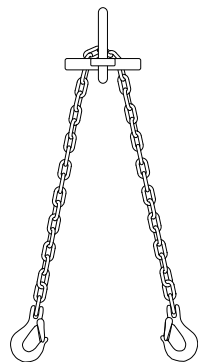

**ABB parts**

ACS880-01 option +C135  
 ACS580-01 option with ordering codes:  
 3AXD50000018852 (R6)  
 3AXD50000018853 (R7)  
 3AXD50000018854 (R8)  
 3AXD50000018855 (R9)

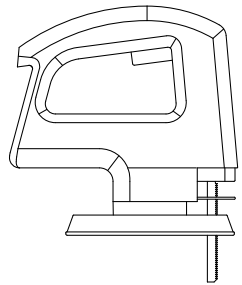
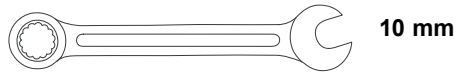
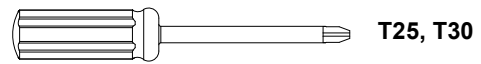
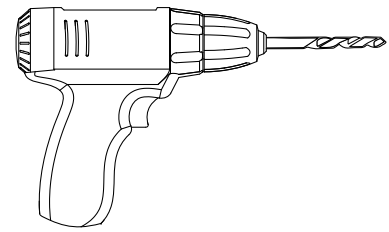
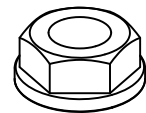
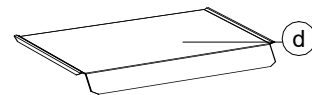
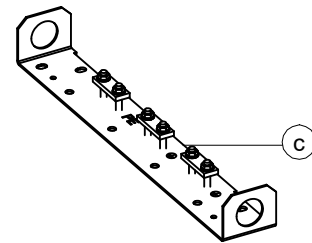
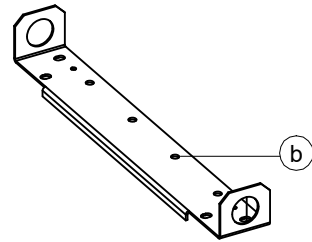
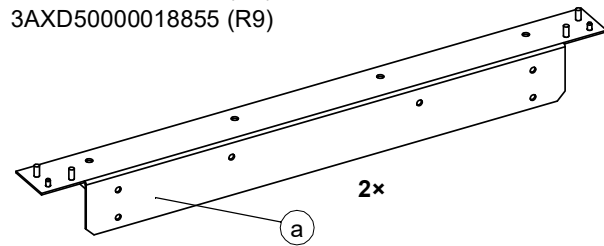

11 ×  
M6 nut

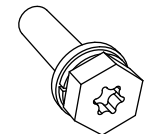

R6...R8:  
16 × M6×25 T25  
R9:  
18 × M6×25 T25



12 ×  
M6×10 T30

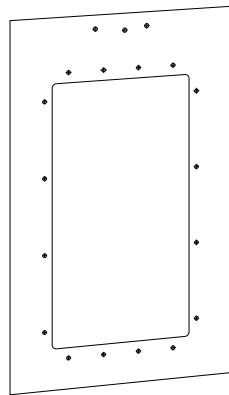

# 2

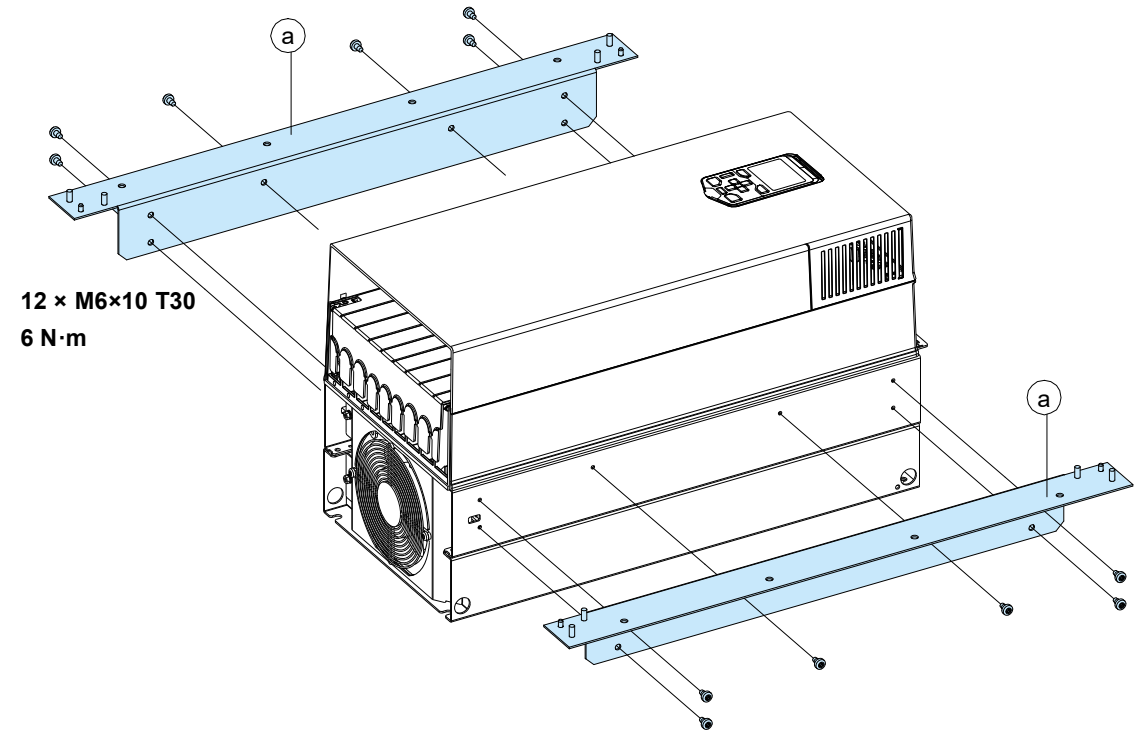

12 × M6×10 T30  
6 N·m

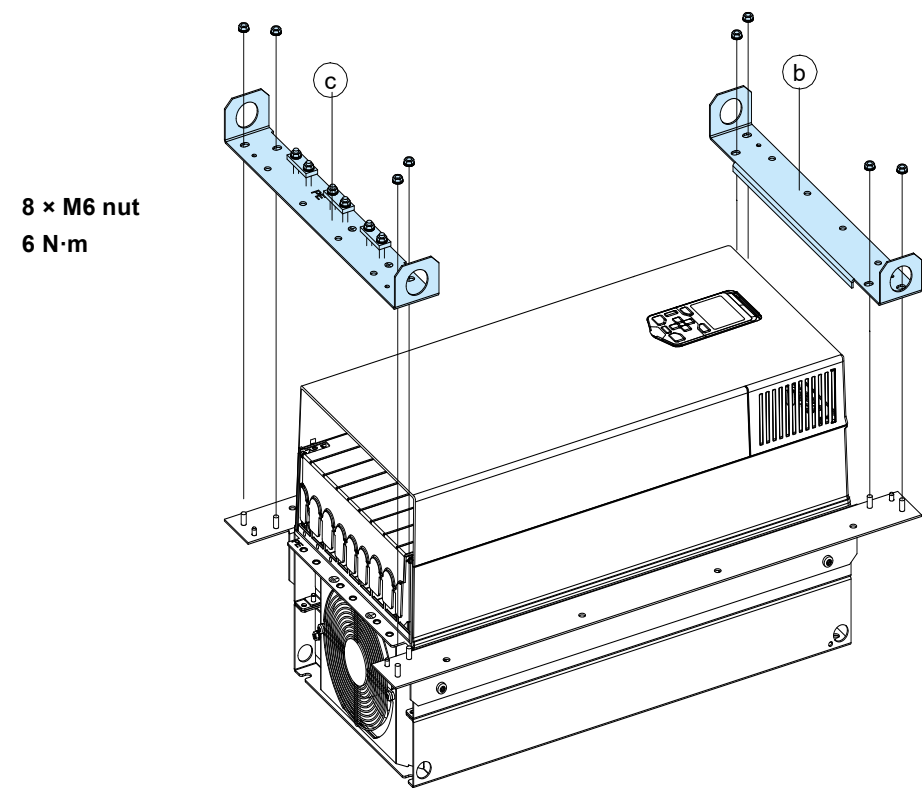

8 × M6 nut  
6 N·m

**3**

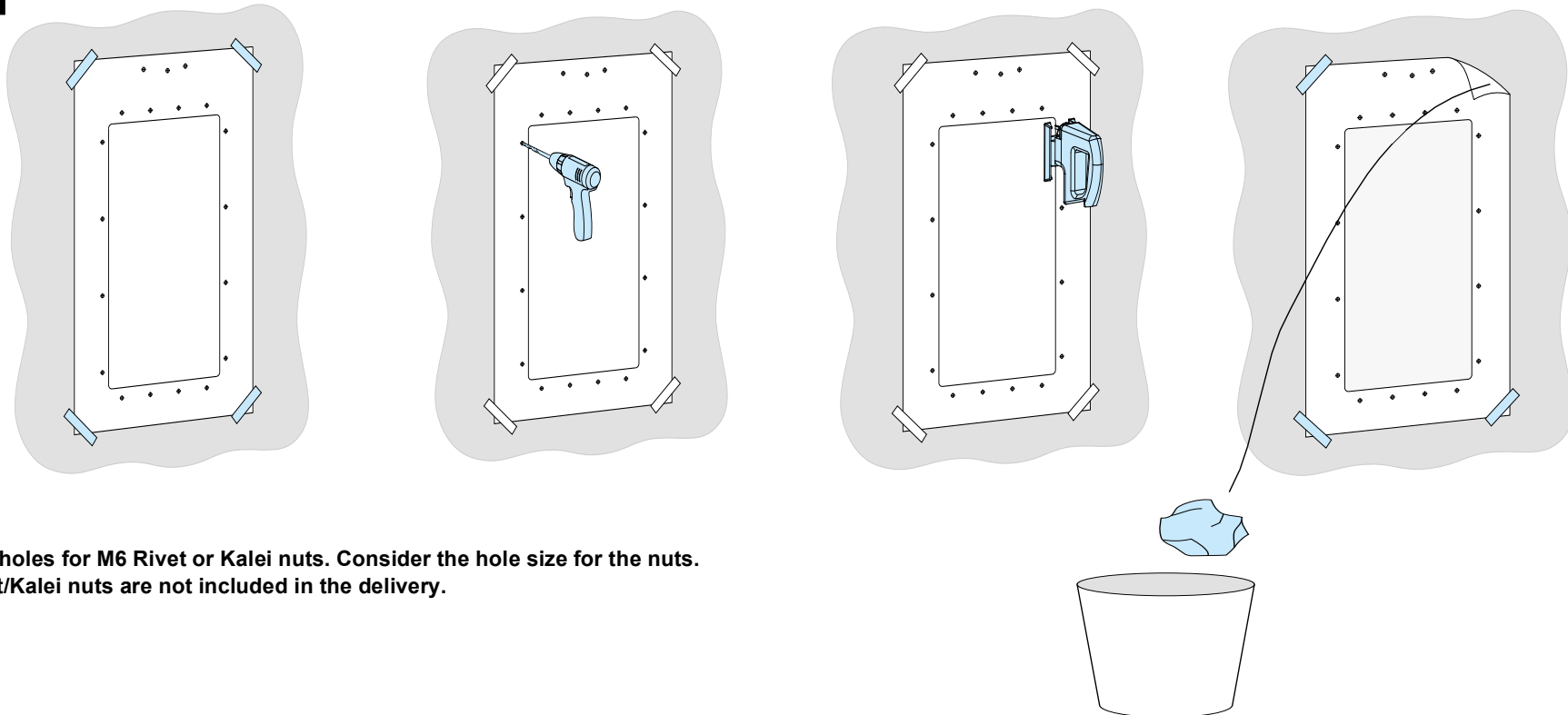

Drill holes for M6 Rivet or Kalei nuts. Consider the hole size for the nuts. Rivet/Kalei nuts are not included in the delivery.

**4**

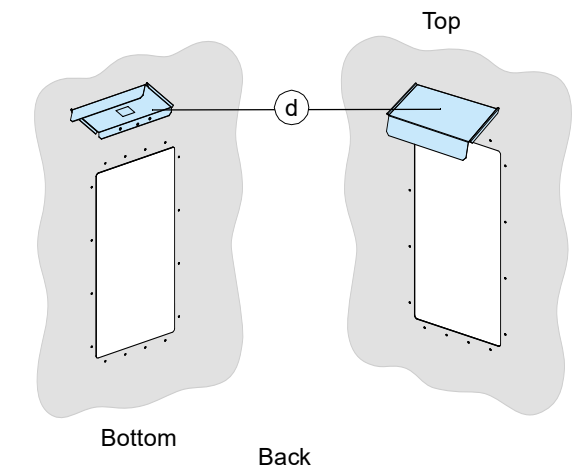
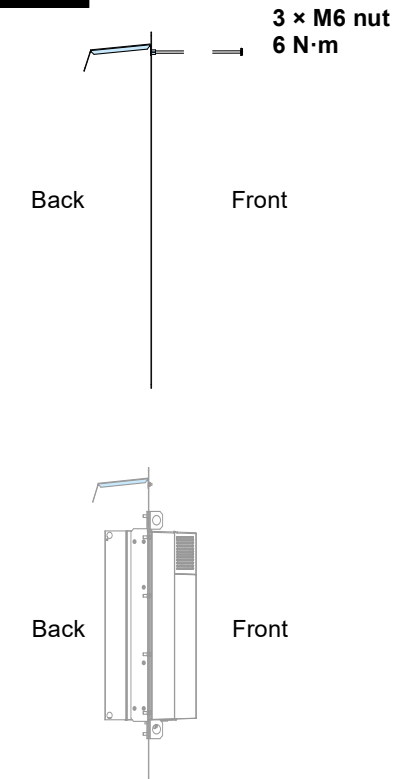

**5**

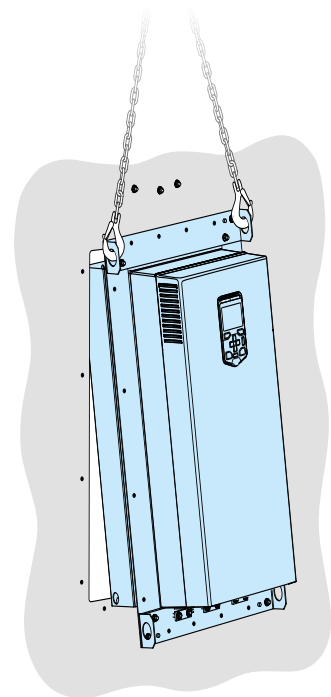

**6**

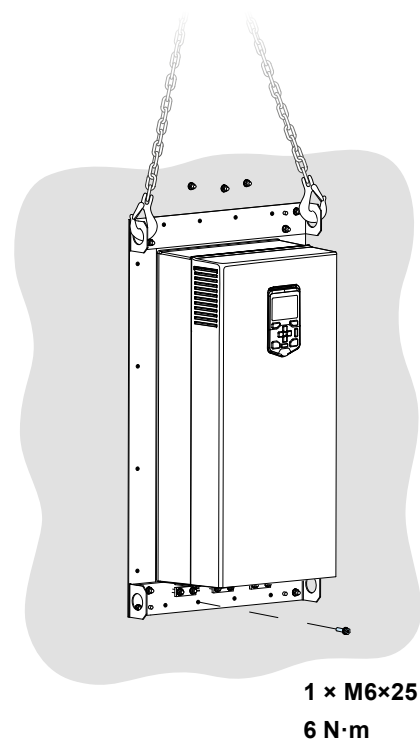

**7**

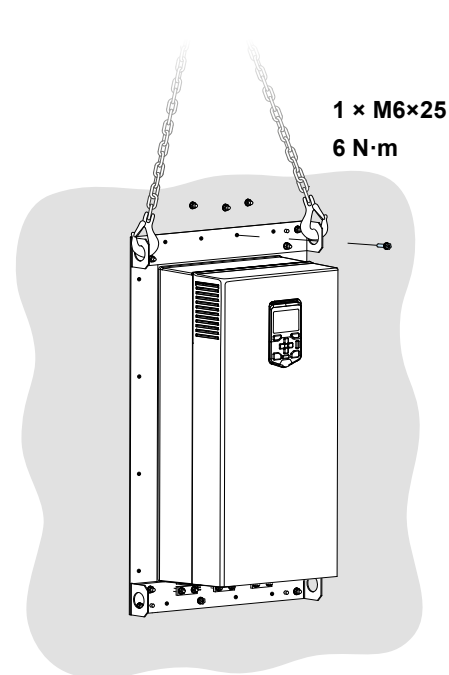

**8**

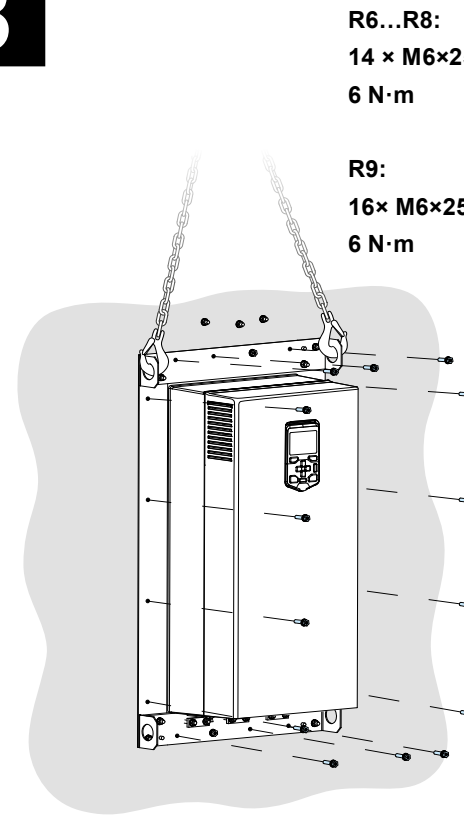

**9**

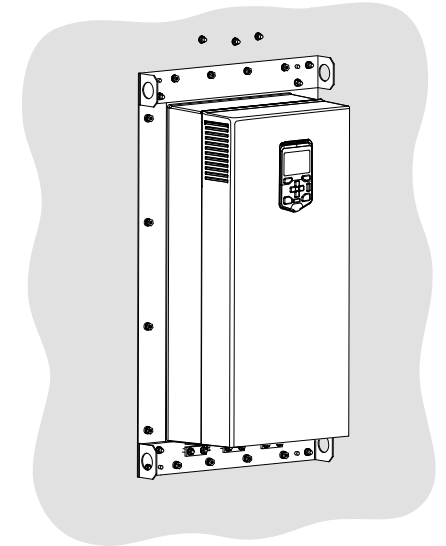

For dimensions, see the mounting template delivered with the flange mounting kit or

- ACS880-01...+C135 drives with flange mounting kit supplement (3AXD50000349814 [English])
- ACS580-01...+C135, ACH580-01...+C135 and ACQ580-01...+C135 drives with flange mounting kit supplement (3AXD50000349821 [English]).

Go to [www.abb.com/drives](http://www.abb.com/drives)



[ACS880-01 manuals](#) [ACS580-01 manuals](#)



[ACH580-01 manuals](#) [ACQ580-01 manuals](#)