

Honeywell

EDC201 / EDC202 / EDC203
Product Manual

51-52-25-155

Revision: 2.0

July 2015

Notices and Trademarks

Copyright 2015 by Honeywell International Inc.

Revision: 2.0, July 2015

While this information is presented in good faith and believed to be accurate, Honeywell disclaims the implied warranties of merchantability and fitness for a particular purpose and makes no express warranties except as may be stated in its written agreement with and for its customers.

In no event is Honeywell liable to anyone for any indirect, special or consequential damages. The information and specifications in this document are subject to change without notice.

Honeywell, PlantScape, Experion PKS, and **TotalPlant** are registered trademarks of Honeywell International Inc.

Other brand or product names are trademarks of their respective owners.

Honeywell International
Process Solutions
1250 W Sam Houston Pkwy S
Houston, TX 77042
1-800 343-0228

About This Document

This document provides descriptions and procedures for the Installation, Configuration, Operation, and Troubleshooting of your the EDC 200 Series Controller.

Revision History

EDC201 / EDC202 / EDC203 Product Manual, Document # 51-52-25-155

Rev 1.0	June 2015	First release
Rev 2.0	July 2015	7 segment code added

Reference

The following list identifies publications that may contain information relevant to the information in this document.

Document Name	Document ID
EDC 200 Series New Wave Controllers Quick Start	51-52-25-156
EDC 200 Series New Wave Controllers Specification	51-52-03-48

Contacts

World Wide Web

The following Honeywell web sites may be of interest to Process Solutions customers.

Honeywell Organization	WWW Address (URL)
Corporate	http://www.honeywell.com
Honeywell Process Solutions	http://honeywellprocess.com

Support and Contact Information

For Europe, Asia Pacific, North and South America contact details, see back page or refer to the appropriate Honeywell Solution Support web site:









Honeywell Corporate	www.honeywellprocess.com
Honeywell Process Solutions	https://www.honeywellprocess.com/en-US/explore/products/instrumentation/panel-mounted-controllers-and-programmers
Training Classes	http://www.honeywellprocess.com/en-US/training



Telephone and Email Contacts

Area	Organization	Phone Number
United States and Canada	Honeywell Inc.	1-800-343-0228 Customer Service
		1-800-423-9883 Global Technical Support
Global Email Support	Honeywell Process Solutions	hfs-tac-support@honeywell.com

Symbol Definitions

The following table lists those symbols used in this document to denote certain conditions.

Symbol	Definition
	ATTENTION: Identifies information that requires special consideration.
	TIP: Identifies advice or hints for the user, often in terms of performing a task.
	REFERENCE -EXTERNAL: Identifies an additional source of information outside of the bookset.
	REFERENCE - INTERNAL: Identifies an additional source of information within the bookset.
CAUTION	Indicates a situation which, if not avoided, may result in equipment or work (data) on the system being damaged or lost, or may result in the inability to properly operate the process.
	CAUTION: Indicates a potentially hazardous situation which, if not avoided, may result in minor or moderate injury. It may also be used to alert against unsafe practices. CAUTION symbol on the equipment refers the user to the product manual for additional information. The symbol appears next to required information in the manual.
	WARNING: Indicates a potentially hazardous situation, which, if not avoided, could result in serious injury or death. WARNING symbol on the equipment refers the user to the product manual for additional information. The symbol appears next to required information in the manual.
	WARNING, Risk of electrical shock: Potential shock hazard where HAZARDOUS LIVE voltages greater than 30 Vrms, 42.4 Vpeak, or 60 VDC may be accessible.
	ESD HAZARD: Danger of an electro-static discharge to which equipment may be sensitive. Observe precautions for handling electrostatic sensitive devices.
	Protective Earth (PE) terminal: Provided for connection of the protective earth (green or green/yellow) supply system conductor.

Symbol	Definition
	Functional earth terminal: Used for non-safety purposes such as noise immunity improvement. NOTE: This connection shall be bonded to Protective Earth at the source of supply in accordance with national local electrical code requirements.
	Earth Ground: Functional earth connection. NOTE: This connection shall be bonded to Protective Earth at the source of supply in accordance with national and local electrical code requirements.
	Chassis Ground: Identifies a connection to the chassis or frame of the equipment shall be bonded to Protective Earth at the source of supply in accordance with national and local electrical code requirements.

Contents

1. INTRODUCTION.....	1
1.1 Overview	1
Function	1
Characteristic	1
Easy to Configure.....	1
Auto Tuning.....	2
Manual/Auto Mode	2
Display	2
LED	5
Function of Keys.....	5
2. INSTALLATION.....	6
2.1 Overview	6
Introduction	6
Pre-installation Information.....	6
2.2 Condensed Specifications.....	7
2.3 Model Number Interpretation	10
Instruction.....	10
2.4 Control and Alarm Relay Contact Information	11
Control Relays.....	11
2.5 Mounting.....	11
Physical Considerations	11
Overall Dimensions	11
Panel Cutout Requirements	12
Mounting Method.....	13
Mounting Procedure	13
2.6 Wiring.....	14
Electrical Considerations	14
2.7 Wiring Diagrams	16
Identify Your Wiring Requirements.....	16
Wiring the Controller.....	16
3. CONFIGURATION.....	17
3.1 Overview	17
3.2 Configuration Prompt Hierarchy.....	18
3.3 Configuration Procedure	19
Introduction	19
Procedure.....	19
3.4 Input Set Up Group.....	20
Introduction	20
Function Prompts	20
3.5 Control Set Up Group.....	23

Introduction	23
Function Prompts	23
3.6 Tune PAR Set Up Group	29
Introduction	29
Function Prompts	29
3.7 ALARM Set Up Group	30
Introduction	30
Function Prompts	30
3.8 Auxiliary Set Up Group	37
Introduction	37
Function Prompts	37
3.9 OPTION Set Up Group.....	38
Introduction	38
Function Prompts	38
3.10 Configuring Analog Input.....	41
Configuring TC Type Input	41
Configuring RTD Type Input.....	42
Configuring Analog Input Burnout	43
Assign Temperature Unit.....	45
3.11 Configuring Control Algorithm.....	46
Configuring ON-OFF Control.....	46
Configuring Time Proportion Control.....	47
Configuring Three Position Step Control.....	48
Configuring Soft Start.....	49
3.12 Configuring Alarm.....	50
Configuring PV Alarm.....	50
Configuring Deviation Alarm.....	51
Configuring Output Alarm.....	53
Configuring Manual Mode Alarm.....	55
Configuring PV Rate of Change Alarm.....	56
Configuring Digital Input Alarm.....	57
Configuring TC Warning Alarm	58
Configuring TC Failing Alarm	59
Configuring Failsafe Alarm	60
Configuring Diagnostic Alarm.....	61
Assign Alarm Hysteresis	62
Configuring Alarm Delay	63
Configuring Alarm Latching.....	64
Configuring Alarm Blocking.....	64
Configuring Timer.....	65
3.13 Configuring Digital Input.....	66
Disable DI Function.....	66
Configuring DI as Control Mode Switch	67
Configuring DI as Control Direction Switch	67
Configuring DI as Keypad Locking Switch DI.....	68
Configuring DI as Timer Initiating Trigger.....	68
Configuring DI as Alarm Acknowledging Switch.....	69
Configuring DI as Auto Tuning Initiating Trigger.....	70

4.	MONITORING AND OPERATING THE CONTROLLER	71
4.1	Overview	71
4.2	Operator Interface.....	71
4.3	Monitoring Your Controller.....	72
	Annunciators	72
	Viewing the operating parameters.....	73
	Diagnostic Messages	73
4.4	Controller Mode	74
	Operation Mode.....	74
	Control Mode.....	74
4.5	Setting Operation Level	75
	Procedure.....	75
4.6	Setting Operation Password.....	76
	Procedure.....	76
4.7	Setting Parameter Mask.....	77
4.8	Reseting to Factory Default.....	78
4.9	Testing Display	78
4.10	Setting Power Frequency.....	79
4.11	Setting Decimal Point Location	80
4.12	Examining Product Information.....	80
4.13	Acknowledge Alarms.....	81
4.14	Setting Auto Tuning.....	82
	Initiating Auto Tuning.....	82
	Starting Through Keypad	82
	Stopping Auto Tuning.....	84
4.15	Switch Manual/Auto Mode.....	84
	Preliminary Steps	84
	Procedure.....	84
4.16	Setting SP	84
	Preliminary Steps	84
	Procedure.....	84
4.17	Setting Timer	85
	Viewing the Timer Current Status.....	85
	Start Timer	85
	Resetting Timer.....	86
4.18	Setting Output Value.....	86
	In Auto Mode	86
	AT is Processing	86
	In Man Mode	87

5. TROUBLESHOOTING/SERVICE	88
5.1 Troubleshooting Aids	88
5.2 Power-up Tests	89
5.3 Background Tests	89
Diagnose System Error	89
Confirm System Error.....	90
6. APPENDIX A LOOK-UP TABLE FOR 7 SEGMENT CHARACTER AND ASSOCIATED ENGLISH WORD.....	91

Tables

Table 1-1: EDC201/ EDC202/ EDC203 Operator Interface (all display items shown)	4
Table 1-2: Function of LED Indicators	5
Table 1-3: Function of Keys	5
Table 2-1: Condensed Specifications	8
Table 2-2: TC/RTD Types and Scope.....	8
Table 2-3: Environmental and Operating Conditions	9
Table 2-4: Model Number Interpretation	10
Table 2-5: Permissible Wiring Bundling	15
Table 3-1: Set Up Parameter Reference	40
Table 4-1 Lower Display Key Parameter Prompts.....	73
Table 4-2: Diagnostic Messages.....	73
Table 6-1 7 Segment Character and Associated English Word	91

Figures

Figure 1-1: EDC201 Operator Interface.....	2
Figure 1-2: EDC202 Operator Interface.....	3
Figure 1-3: EDC203 Operator Interface.....	4
Figure 2-1: Overall Dimensions	11
Figure 2-2: Panel Cutout Requirements	12
Figure 2-3: Composite Wiring Diagram Figure	16
Figure 3-1: Configuration Prompt Hierarchy	18
Figure 4-1: Operator Interface (EDC201, EDC202).....	71
Figure 4-2 Operator Interface (EDC203)	72

1. Introduction

1.1 Overview

Function

The EDC 200 series are microprocessor-based stand-alone temperature controllers. They combine a high degree of functionality and operating simplicity.

EDC 200 series controllers are available in the following three panel mount sizes:

- EDC201:1/16 DIN
- EDC202:1/8 DIN
- EDC203:1/4 DIN

This instrument is an ideal controller for regulating temperature in numerous heating and cooling applications, as well as in metal working, food, pharmaceuticals, semiconductor, testing and environmental work. The EDC 200 series monitor and control temperatures in applications such as environmental chambers, plastic processing machines, furnaces and ovens, and packaging machinery.

Characteristic

Input Type

- One analog input
The analog input supports thermocouples (TC) or resistive temperature detector (RTD - two input method). Analog Input accuracy: $\pm 0.5\%$;
- One digital input
The digital input supports external dry contacts or isolated solid state contacts.

Output Type

- One control output: Electromechanical relay output or SSR driver output.
- Alarm outputs.
One alarm output (EDC201)
Two alarm outputs (EDC201 and EDC203)

Display

7-segment display

Power Supply

- 100-240 VAC 50Hz or 60 Hz (-15% to 10%)
- 24 V DC (-20% to 20%)

Easy to Configure

The controller supports two configuration levels, operator level and configuration level, that make parameter configuration simpler.

Inadvertent controller configuration can be prevented by hiding some parameters. A 4-digit security code prevents unauthorized modifications.

Auto Tuning

Auto tuning is used for auto-tuning of your process and automatic identification and controller setting of PID tuning parameters. Auto tuning is initiated by the user at the controller, typically during initial start-up of the system.

Manual/Auto Mode

- In Manual mode
Operators directly control the controller output level in the Manual mode of operation and the output variable is displayed on the controller. The percent output may be changed by operators by increasing or decreasing the limits allowed by the output value. The controller will generate the final control output automatically (0 to 100% for a time proportioning output or -5 to 105% for a current output).
- In Auto mode
The controller generates the final control output automatically using internal algorithms that reference the current PV and the target Set Point values.

Display



Figure 1-1: EDC201 Operator Interface

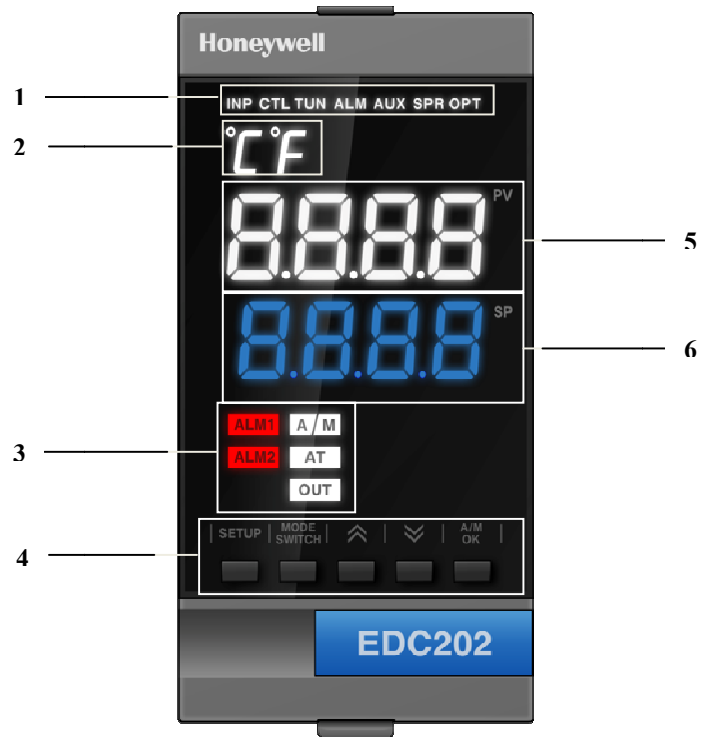

Figure 1-2: EDC202 Operator Interface



Figure 1-3: EDC203 Operator Interface

Callout	Item	Description
1	Navigation Bar	In normal operating mode, it is not displayed. In configuration mode, selected Set Up Group Name is displayed.
2	Temperature Unit	Selected system temperature unit
3	LED Indicators	Indicate the status of external output, auto tuning, alarm output and Manual/Auto control mode. Refer to Table 1-2: Function of LED Indicators for specific information.
4	Keys	Refer to Table 1-3: Function of Keys for specific information.
5	Upper Display	In normal operating mode, the 4-digit current PV value is displayed. In configuration mode, the selected parameter name is displayed.
6	Lower Display	In normal operating mode, the 4-digit Set Point value is displayed. In configuration mode, selected parameter value is displayed.

Table 1-1: EDC201/ EDC202/ EDC203 Operator Interface (all display items shown)

LED

The following table shows each LED indicator on the operator interface and defines its function.

LED Indicator	Function
OUT	Indicates the enable or disable status of external output. The external output is enabled when the light is on.
AT	Indicates the enable or disable status of auto tuning. Auto tuning is enabled when the light is on.
MAN(EDC201)	Indicates the status of Manual or Auto control mode. In Manual control mode when the light is on. It is Auto control mode when the light is off.(Applicable to EDC201)
A/M(EDC202,EDC203)	Indicates the status of Manual or Auto control mode. Auto control mode when A is on. Manual control mode when M is on.(Applicable to EDC202, EDC203)
ALM1	Indicates the output status of Alarm1. There is a alarm output when the light is on.
ALM2(EDC202,EDC203)	Indicates the output status of Alarm2. There is a alarm output when the light is on.(Applicable to EDC202, EDC203)

Table 1-2: Function of LED Indicators

Function of Keys

The following table shows each key on the operator interface and defines its function.





Key	Function
	In normal operating mode, long press the key to enter the configuration mode. In configuration mode, long press the key to switch back to the normal operating mode, short press the key to cycle through the menu items.
	In normal operation mode, short press the key to switch the lower display parameters or enable various functions. In configuration mode, short press the key to cycle parameters in a set up group.
	To increase the values for the selected parameter or switch to the next item.
	To decrease the values for the selected parameter or switch back to the previous item.
	In normal operating mode, short press the key to switch Auto/ Manual control mode. In configuration mode, short press the key to save and confirm settings. Long press the key to enable Auto Tuning when the enable conditions are fulfilled.

Table 1-3: Function of Keys

2. Installation

2.1 Overview

Introduction

Installation of the EDC 200 series consists of mounting and wiring the controller according to the instructions provided in this section. Read the pre-installation information, check the model number interpretation, become familiar with your model selection, then proceed with installation.

Pre-installation Information

If the controller has not been removed from its shipping carton, inspect the carton for damage then remove the controller.

- Inspect the unit for any obvious shipping damage and report any damage due to transit to the carrier.
- Make sure a bag containing mounting hardware is included in the carton with the controller.
- Check that the model number shown on the product agrees with what you have ordered.

2.2 Condensed Specifications

Honeywell recommends that you review and adhere to the operating limits listed in Table 2-1: Condensed Specifications, Table 2-2: TC/RTD Types and Scope, and Table 2-3: Environmental and Operating Conditions when operating your controller.

Specifications		
Inputs	Input Type	TC: E, J,K,Platinel II,Ni-Ni-Moly,R,S,T RTD: PT100,PT100(Low)
	Input Sampling Time	TC: 250ms RTD: 350ms
Control	Relay output	Dry contact /NO 5A@ 30 VDC or 250 VAC
	SSR Driver Output	24VDC/20 mA
	Algorithm	ON-OFF
		Time proportioning
TPSC		
Alarm	Outputs	Dry contact/NO 5A@ 30 VDC or 250 VAC
	Mode	PROCESS VARIABLE
		DEVIATION
		OUTPUT
		CONTROL MODEALARM
		PV RATE OF CHANGE
		DIGITAL INPUT
		THERMOCOUPLE WARNING
		THERMOCOUPLE FAILING
		FAILSAFE
		SYSTEM DIAGNOSTIC
TIMER ALARM		
LED	PV/SP indicator	4-digit, 7-segment display
	Indication accuracy	0.5%
	Alarm relay status	Alarm1 or Alarm2

2. Installation

2.2. Condensed Specifications

Specifications		
	Control Mode	Auto or Manual
	Units of temperature	°F or °C
	Control relay status	Output
	Auto tuning status	Operating status
	Menu	7 LED indicators
Certification	CE	EMC: EN 61326-1 2006 Low Voltage Directive: EN 61010-1 2010 (Both are "Self Declared")
	UL	ANSI/UL 61010-1 Third Edition
	CSA	CAN/CSA-C22.2 No. 61010-1-12 Third Edition

Table 2-1: Condensed Specifications

TC/RTD Types and Scope		
		Units: C
TC	E Thermocouple High	270 to 1000
	J Thermocouple High	-18 to 871
	K Thermocouple High	-18 to 1316
	Ni-Ni-Moly Thermocouple High	0 to 1371
	Platinel II Thermocouple High	0 to 1380
	R Thermocouple	18 to 1704
	S Thermocouple	-18 to 1704
	T Thermocouple High	-184 to 371
RTD	PT100 (Low)	-184 to 149
	PT100	-184 to 649

Table 2-2: TC/RTD Types and Scope

Environmental and Operating Conditions				
Parameter	Reference	Rated	Operative Limits	Transportation and Storage
Ambient Temperature	25 ± 3°C	15 to +55°C	0 to +55°C	-40 to +66°C
	77 ± 5°F	58 to 131°F	32 to 131°F	-40 to 151°F
Relative Humidity	10 to 55*(*)	10 to 90*(*)	5 to 90*(*)	5 to 95*(*)
IP or NEMA Rating	Front Panel IP54 NEMA 3R			
Vibration				
Frequency (Hz)	0	0 to 200		0 to 200
Acceleration (g)	0	0.6		0.5
Mechanical Shock				
Acceleration (g)	0	5	5	20
Duration (ms)	0	30	30	30

Table 2-3: Environmental and Operating Conditions



ATTENTION

* The maximum moisture rating only applies up to 40 °C (104 °F). For higher temperatures, the RH specification is derated to maintain constant moisture content.

2.3 Model Number Interpretation

Instruction

- Select the desired Key Number. The arrow to the right marks the selections available.
- Make one selection each from Tables I through II using the column below the proper arrow. A dot (•) denotes unrestricted availability. A letter denotes restricted availability.

Key Numbers						Table I			Table II	
E	D	C	2	0	_	-	-	-	-	-

KEY NUMBER

Description		Selection	Availability		
Size	48 x 48 mm (1/16 DIN), 1x AI, 1x ALM, 1x DI	EDC201	↓		
	48 x 96 mm (1/8 DIN), 1x AI, 2x ALM, 1x DI	EDC202		↓	
	96 x 96 (1/4 DIN), 1x AI, 2x ALM, 1x DI	EDC203			↓

Table I

Power	100-240 VAC Power	0 _ _	•	•	•
	24 VDC Power	1 _ _			
Control Output	Relay, Dry Contact / N.O., 5A @ 30 Vdc or 250 VAC	_ 0 _	•	•	•
	SSR Drive, 24 VDC @ 20 mA	_ 1 _			
Future	None	_ _ 0	•	•	•

TABLE II

Future	None	0 _	•	•	•
Future	None	_ 0	•	•	•

Table 2-4: Model Number Interpretation

2.4 Control and Alarm Relay Contact Information

Control Relays



ATTENTION

Control relays operate in the standard control mode (that is, energized when output state is on).

2.5 Mounting

Physical Considerations

The controller can be mounted on either a vertical or tilted panel using the mounting kit supplied. Adequate access space must be available at the back of the panel for installation and servicing activities.

Overall dimensions and panel cutout requirements for mounting the controller are shown in Figure 2-2: Panel Cutout Requirements.

Overall Dimensions

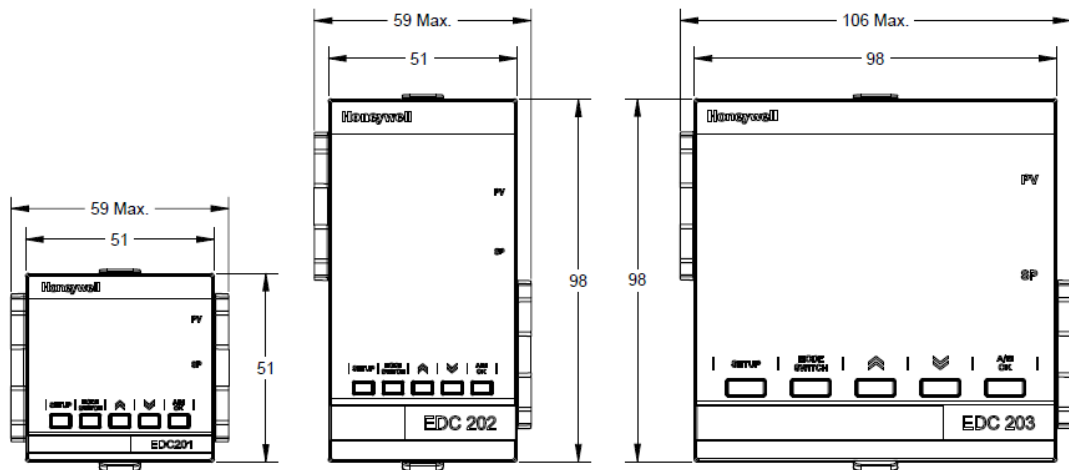

Figure 2-1: Overall Dimensions

2. Installation
2.5. Mounting

Panel Cutout Requirements

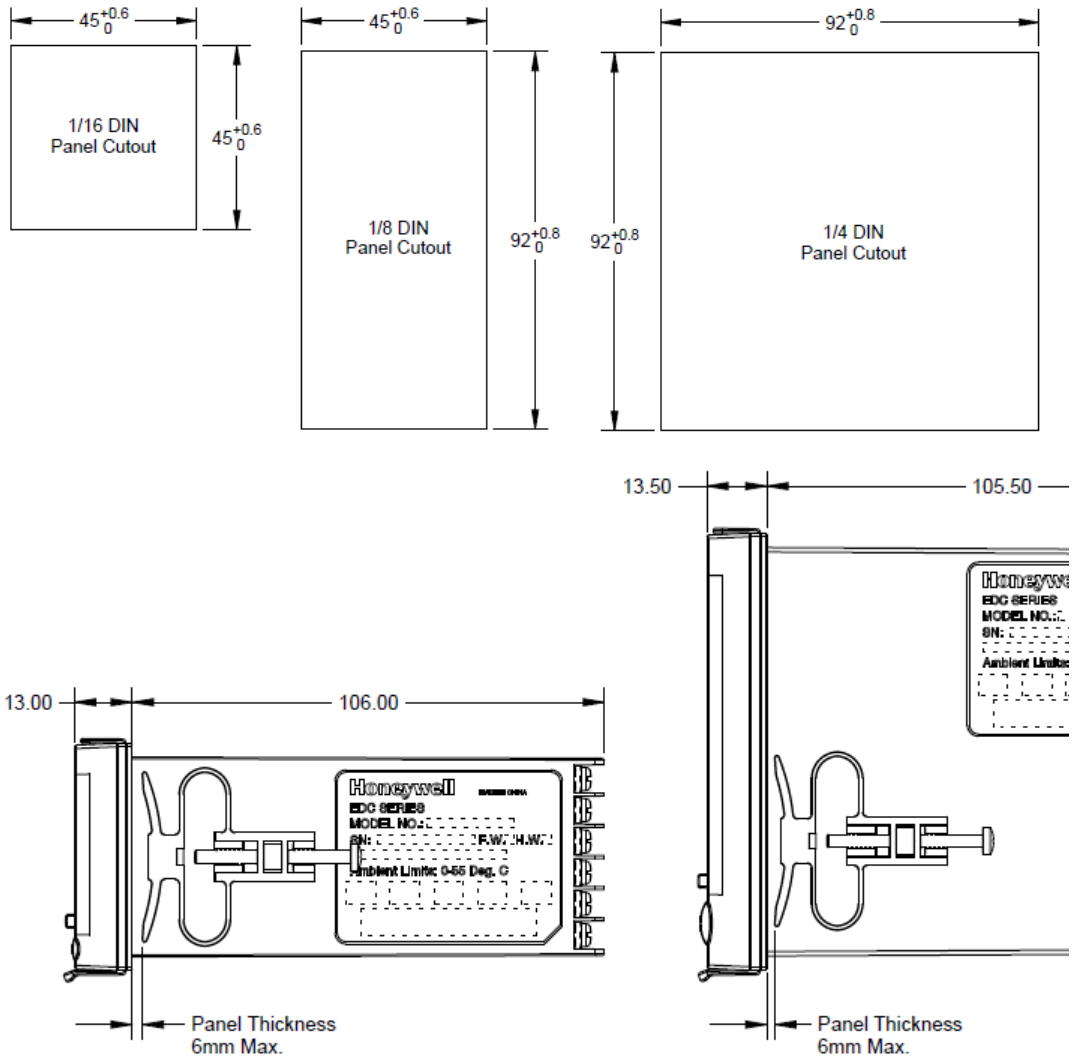
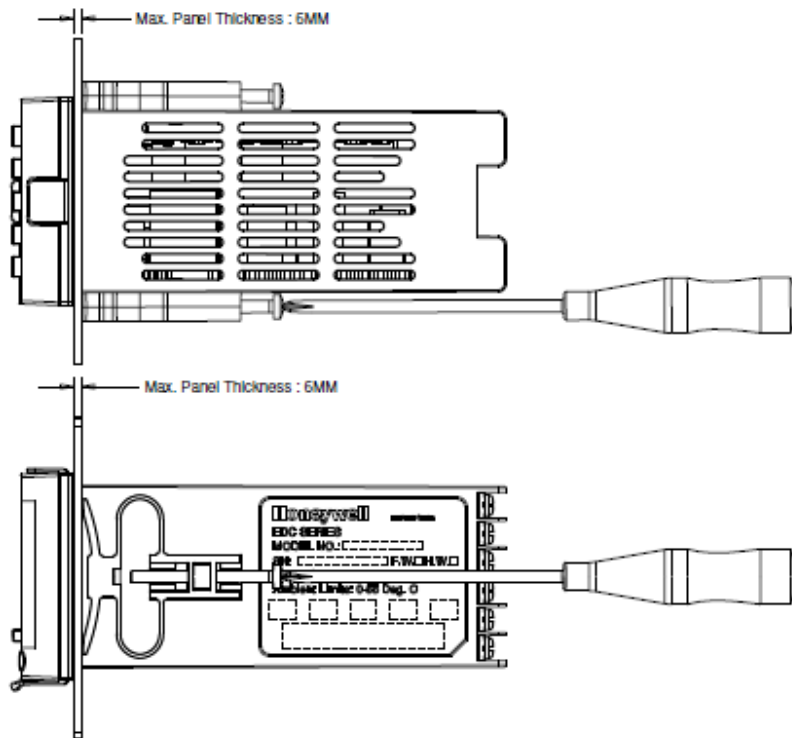

Figure 2-2: Panel Cutout Requirements

Mounting Method



Before mounting the controller, refer to the nameplate on the outside of the case and make a note of the model number. It will help later when selecting the proper wiring configuration.

Mounting Procedure

1. Orient the case properly and slide it through the panel hole from the front.
2. Insert the prongs of the clips into the two holes on the left and right side of case.
3. Tighten screws to secure the mounting kit against the panel.

CAUTION Over tightening will cause mounting kit damage and a loose fit will result in improper unit installation.

2.6 Wiring

Electrical Considerations

Line voltage wiring

This controller is considered “rack and panel mounted equipment” per EN61010-1, Safety Requirements for Electrical Equipment for Measurement, Control, and Laboratory Use, Part 1: General Requirements. Conformity with 72/23/EEC, the Low Voltage Directive requires the user to provide adequate protection against a shock hazard. The user shall install this controller in an enclosure that limits OPERATOR access to the rear terminals.

Mains Power Supply

Each controller size supports two power supply types. One mode type is suitable for connection to 100 to 240 Vac power supply mains, the other is suitable for connection to 24 Vdc power supply mains. There is a built-in 33V, 750mA self recovery fuse for 24 Vdc applications. It is the user’s responsibility to provide a switch and non-time delay (North America), quick-acting, high breaking capacity, Type F (Europe), 1/2A, 250V fuse(s), or circuit breaker for 100-240 Vac applications. The switch or circuit breaker shall be located in close proximity to the controller, *within easy reach of the OPERATOR*. The switch or circuit breaker shall be marked as the disconnecting device for the controller.

CAUTION Applying 100-240 Vac to an instrument rated for 24 Vdc will severely damage the instrument and is a fire and smoke hazard.

When applying power to multiple instruments, make certain that sufficient current is supplied. Otherwise, the instruments may not start up normally due to the voltage drop caused by the in-rush current.

Control/Alarm Circuit Wiring

The insulation of wires connected to the Control/Alarm terminals shall be rated for the highest voltage involved. Extra Low Voltage (ELV) wiring (input, current output, and low voltage Control/Alarm circuits) shall be separated from HAZARDOUS LIVE (>30 Vac, 42.4 Vpeak, or 60 Vdc) wiring per Permissible Wiring Bundling, Table 2-5.

Electrical Noise Precautions

Electrical noise is composed of unabated electrical signals, which produce undesirable effects in measurements and control circuits.

Digital equipment is especially sensitive to the effects of electrical noise. Your controller has built-in circuits to reduce the effect of electrical noise from various sources. If there is a need to further reduce these effects:

Separate External Wiring—Separate connecting wires into bundles (See Permissible Wiring Bundling - Table 2-5) and route the individual bundles through separate conduit metal trays.

Use Suppression Devices—For additional noise protection, you may want to add suppression devices at the external source. Appropriate suppression devices are commercially available.



ATTENTION

For additional noise information, refer to document number 51-52-05-01, *How*

to Apply Digital Instrumentation in Severe Electrical Noise Environments.

Permissible Wiring Bundling

Table 2-5: Permissible Wiring Bundling

Bundle No.	Wire Functions
1	<ul style="list-style-type: none"> • Line power wiring • Earth ground wiring • Line voltage control relay output wiring • Line voltage alarm wiring
2	<p>Analog signal wire, such as:</p> <ul style="list-style-type: none"> • Input signal wire (thermocouple, 4 to 20 mA, etc.) • 4-20 mA output signal wiring <p>Digital input signals</p>
3	<ul style="list-style-type: none"> • Low voltage alarm relay output wiring • Low voltage wiring to solid state type control circuits • Low voltage wiring to open collector type control circuits

2.7 Wiring Diagrams

Identify Your Wiring Requirements

To determine the appropriate diagrams for wiring your controller, refer to the model number interpretation in this section. The model number of the controller is on the outside of the case.

Wiring the Controller

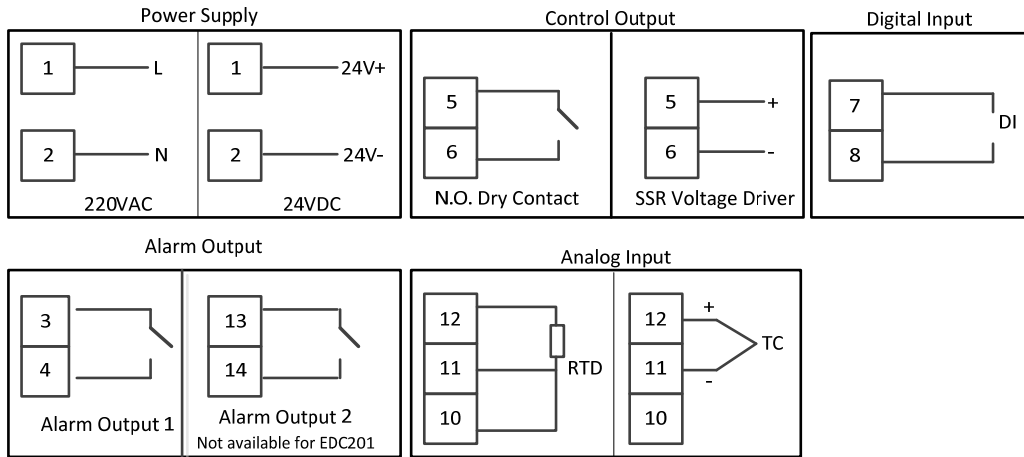

Figure 2-3: Composite Wiring Diagram Figure

Callout	Details
1	AC Line Voltage Terminals
2	Alarm Terminals
3	Control Input Terminals
4	TC/RTD Input Terminals
5	Reserved Terminals
6	Switching Value Terminals

3. Configuration

3.1 Overview

Configuration is a dedicated operation where you use straightforward keystroke sequences to select and establish (configure) pertinent control data best suited for your application.

To assist you in the configuration process, there are prompts that appear in the top, upper and lower displays. These prompts let you know what group of configuration data (Set Up prompts) you are working with and also, the specific parameters (Function prompts) associated with each group.

3.2 Configuration Prompt Hierarchy

Figure 3-1: Configuration Prompt Hierarchy

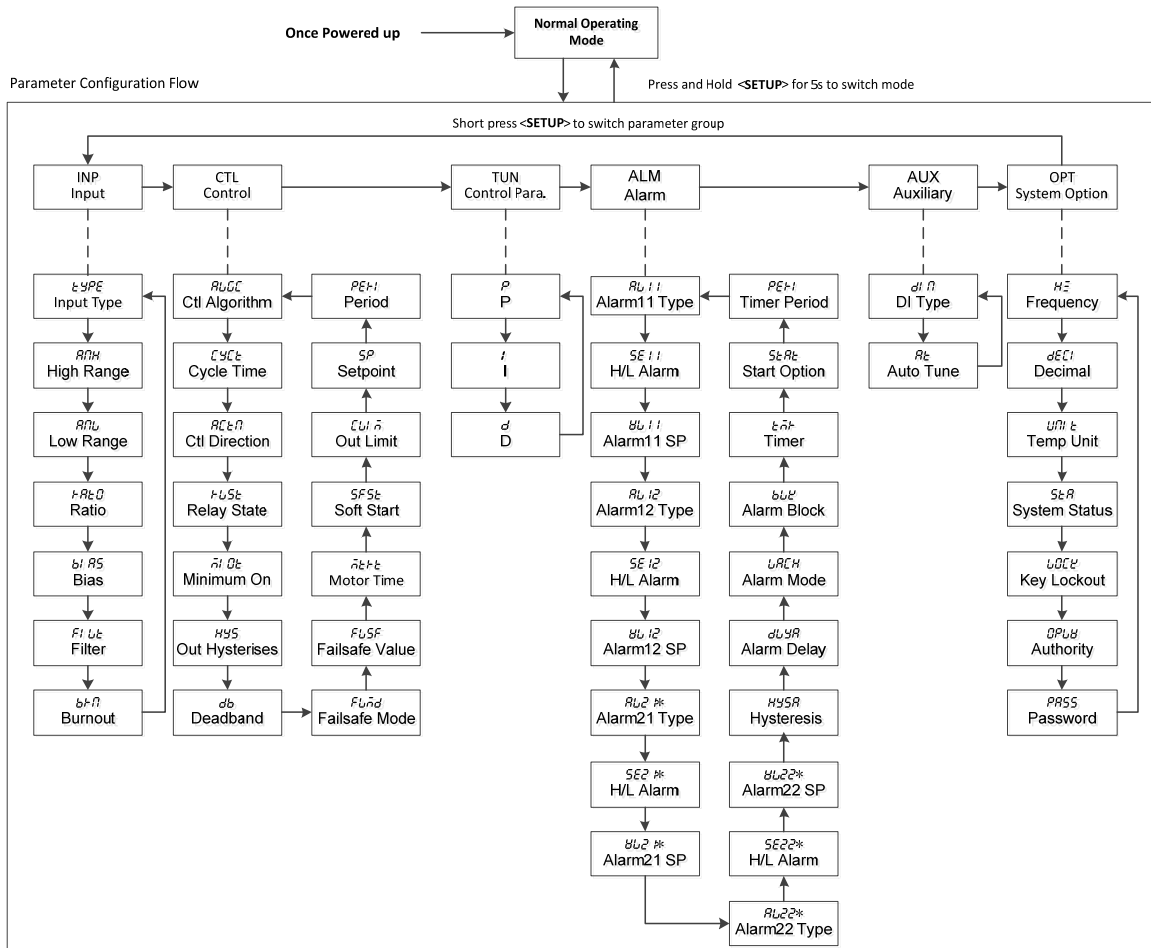







3.3 Configuration Procedure

Introduction

Each of the Set Up groups and their functions are pre-configured at the factory. The factory settings are shown in Table 3-1 that follow this procedure.

If you want to change any of these selections or values, follow the below procedure. This procedure tells you the keys to press to get to any Set Up group and any associated Function parameter prompt.

Procedure

Step	Action	Press	Result
1	Enter Set Up Mode	Long press 	Top Display= INP (This is the first Set Up Group title) Upper Display= <i>TYPE</i>
2	Select any Set Up Group		Sequentially displays the other Set Up group titles shown in the prompt hierarchy in Figure 3-1 Configuration Prompt Hierarchy. Stop at the Set Up group title that describes the group of parameters you want to configure. Then proceed to the next step.
3	Select a Function Parameter		Upper Display = the first Function prompt within that Set Up group. Lower Display = the current value or selection for the first function prompt of the selected Set Up group. Sequentially displays the other function prompts of the Set Up group you have selected. Stop at the function prompt that you want to change, then proceed to the next step.
4	Change the Value or Selection	 or 	Increments or decrements the value or selection that appears for the selected function prompt.
5	Enter the Value or Selection		Enters value or selection made into memory after another key is pressed.
6	Exit Configuration	Long press  or without any key operation more than 30s.	The controller exits Configuration Mode and returns to Normal Operation Mode.

3.4 Input Set Up Group

Introduction

This data deals with various parameters required to configure the Input.

Function Prompts

Set up Group	Function Prompt	7-Segment Code	Default Value	Selection or Range of Setting	7-Segment Code	Parameter Definition
Top Display		Upper Display		Lower Display		
Input	TYPE	TYPE	Disable	Disable	dl 5b	Disabled
				E	EH	E Thermocouple High
				J	JH	J Thermocouple High
				N	NNH	Ni-Ni-Moly Thermocouple High
				KH	EH	K Thermocouple High
				P	PLH	P Thermocouple
				R	r	R Thermocouple
				S	s	S Thermocouple
				T	EH	T Thermocouple High
				PT100	100	100 Ohm RTD High
				PT100(Low)	100L	100 Ohm RTD Low
	Rhi	RHH	100	-999 ~ 9999	100	Input high range value. Input high range of TC and RTD input types are generated by searching the corresponding table automatically depending on the input type. It cannot be modified.

Set up Group	Function Prompt	7-Segment Code	Default Value	Selection or Range of Setting	7-Segment Code	Parameter Definition
Top Display		Upper Display		Lower Display		
	Rlow	<i>RFLW</i>	0	-999 ~ 9999	<i>0</i>	Input low range value. Input high range of TC and RTD input types are generated by searching the corresponding table automatically depending on the input type. It cannot be modified.
	RATIO	<i>RRTD</i>	1	-20.00 ~ 20.00		Ratio on input.
	BIAS	<i>BIAS</i>	0	-999 ~ 9999		Bias is used to compensate the input for drift of an input value due to deterioration of a sensor, or some other cause. Select the Bias value you want on the Input.
	FILTER	<i>FILT</i>	0	0 ~ 120s		A software digital filter is provided for the Input to smooth the input signal. 0 means filtering prohibited.
	BURNOUT	<i>BURN</i>	FS	FS	<i>FS</i>	Pre-configured Failsafe output (selected in the CONTROL Set up Group) applied if a failed input is detected (does not apply for an input out of range).

3. Configuration
 3.4. Input Set Up Group

Set up Group	Function Prompt	7-Segment Code	Default Value	Selection or Range of Setting	7-Segment Code	Parameter Definition
Top Display		Upper Display		Lower Display		
				UP	<i>UP</i>	<p>UPSCALE BURNOUT will force the Input signal to the full scale value when the sensor fails.</p> <p>The maximum permissible PV value shall be:</p> <p>The maximum value = Ratio *(High Range + 1% of range span) + Bias;</p> <p>Which shall not be greater than (High Range + 10% of range span)</p>
				DOWN	<i>d0wn</i>	<p>DOWNSCALE BURNOUT will force the Input signal to the lower range value when the sensor fails.</p> <p>The minimum permissible PV value shall be:</p> <p>The minimum value = Ratio*(Low Range – 1% of range span) + Bias;</p> <p>Which shall not be less than (Low Range – 10% of range span)</p>
				NO FS	<i>no FS</i>	<p>No configured Failsafe output applied if failed input is detected. This selection provides input failure detection and alarm.</p>

3.5 Control Set Up Group

Introduction

The functions listed in this group deal with how the controller will control the process including: Control algorithm, Cycle time, Set Point Limits, Output Direction and Limits, Deadband, Soft Start and Timer period.

Function Prompts

Set up Group	Function Prompt	7-Segment Code	Default Value	Selection or Range of Setting	7-Segment Code	Parameter Definition
Top Display		Upper Display		Lower Display		
Control	CTL ALG	RLCC	ON-OFF	ON-OFF	000FF	The difference(PV-SP) of Process Variable (PV) and the Set Point (SP) determines the output. The output can be either ON (100 %) or OFF (0%). In direct acting control, when the error signal is positive, the output is 100 %; and when the error signal is negative, the output is 0 %. If the control action is reverse, the opposite is true.
				Time A	ELAR	Time Proportional Output based on PID A has a resolution of 3.33 msec. Cycle Time is adjustable from 1 to 120 seconds.

3. Configuration

3.5. Control Set Up Group

Set up Group	Function Prompt	7-Segment Code	Default Value	Selection or Range of Setting	7-Segment Code	Parameter Definition
Top Display		Upper Display		Lower Display		
				Time B	ti nb	<p>Proportional Output based on PID B has a resolution of 3.33 msec. Cycle Time is adjustable from 1 to 120 seconds.</p> <p>Unlike the PID A equation, the controller gives only an integral response to a setpoint change, with no effect on the output due to the gain or rate action, and it gives full response to PV changes. Otherwise controller action is as described for the PID A equation.</p>

Set up Group	Function Prompt	7-Segment Code	Default Value	Selection or Range of Setting	7-Segment Code	Parameter Definition
Top Display		Upper Display		Lower Display		
				TPSC	TPSC	<p>The Three Position Step Control algorithm allows the control of a valve (or other actuator) with an electric motor driven by two controller relay outputs.</p> <p>The Three Position Step Control algorithm provides an output display (OUT) which is an estimated motor position, since the motor is not using any slidewire feedback. Although this output indication is only an approximation, it is "corrected" each time the controller drives the motor to one of its stops (0 % or 100 %).</p>
	CYC Time	CYC	1	1~ 120		Cycle time used for time proportioning control. If the control output type is RLY, Units: s; if the control out type is SSR driver, Units: 1/3s
	ACTION	ACTN				CONTROL OUTPUT DIRECTION: Select direct or reverse output action.

3. Configuration
3.5. Control Set Up Group

Set up Group	Function Prompt	7-Segment Code	Default Value	Selection or Range of Setting	7-Segment Code	Parameter Definition
Top Display		Upper Display		Lower Display		
			REVERSE	Reverse	1-EB1	REVERSE ACTING CONTROL: Based on the PID control, the controller's output decreases as the process variable increases.
				Direct	dl 1-E	DIRECT ACTING CONTROL—Based on the PID control, the controller's output increases as the process variable increases.
	RLYSTATE	1-LS1	OFF	OFF	0FF	It is used for controlling the digital output. Digital output de-energizes when the control output is 0%.
				ON	0n	It is used for controlling digital output. Digital output energizes when control output is 0%.
	Minimun On Time	ni 0t	3	1 ~ 6		Keeps the high level enabled for set time each time the output is enabled. ATTENTION Only applicable for ON/OFF control.

Set up Group	Function Prompt	7-Segment Code	Default Value	Selection or Range of Setting	7-Segment Code	Parameter Definition
Top Display		Upper Display		Lower Display		
	OUT HYST	<i>HY5</i>	2%	0 ~ 100% of PV span		HYSTERESIS (OUTPUT RELAY) is an adjustable overlap of the ON/OFF states of each control output. This is the difference between the value of the process variable at which the control outputs energize and the value at which they de-energize. ATTENTION Only applicable for ON/OFF control.
	DEADBAND	<i>db</i>	1%	0.5 ~ 5.0%		DEADBAND is an adjustable gap between the operating ranges of output 1 and output 2 in which neither output operates (positive value) or both outputs operate (negative value). Apply to TPSC.
	FAILMODE	<i>FLnd</i>	Latch	Latch	<i>LR</i>	Controller goes to Manual mode; output goes to failsafe value.
				No Latch	<i>noLR</i>	Controller stays in last mode that was being used (Automatic or Manual); output goes to failsafe value.
	FAILSAFE	<i>FLSF</i>	0	0 ~ 100%		Failsafe output value.

3. Configuration
3.5. Control Set Up Group

Set up Group	Function Prompt	7-Segment Code	Default Value	Selection or Range of Setting	7-Segment Code	Parameter Definition
Top Display		Upper Display		Lower Display		
	Motor TI	ᄁᄁᄁᄁ	5	5 ~ 1800s		MOTOR TIME – Appears only when “TPSC” (Three Position Step Control) is selected as the Control Algorithm. This is the time it takes the motor to travel from 0 to 100 % (fully closed to fully open). This time can usually be found on the nameplate of the motor.
	Soft Start	5F5ᄁ	DISABLE	DISABLE	dᄁ 5b	Disable the soft-start feature.
				ENABLE	ᄁᄁbᄁ	Enable the soft-start feature.
	Output Limit	ᄁᄁᄁ ᄁ	0%	0% ~ 100%		Soft Start Output Power Limit is the limit output applied to the heater or the machine at power up.
	Set Point	5P	0	Same as PV Range		Soft Start Set Point is the threshold for the Soft Start Timer. Soft Start function ends when the PV reaches the Soft Start Set Point or the Timer elapses.

Set up Group	Function Prompt	7-Segment Code	Default Value	Selection or Range of Setting	7-Segment Code	Parameter Definition
Top Display		Upper Display		Lower Display		
	PERIOD	PEH	0	0:00min ~ 99.59min		PERIOD allows you to configure the length of timeout period. Soft Start function ends when the PV is above the Soft Start Set Point or the Timer elapses.

3.6 Tune PAR Set Up Group

Introduction

Tuning consists of establishing the appropriate values for the tuning constants you are using so that your controller responds correctly to changes in process variable and Set Point. You can start with predetermined values but you will have to watch the system to see how to modify them. The Accutune feature automatically selects Gain, Rate, and Reset on demand.



ATTENTION

Because this group contains functions that have to do with security and lockout, we recommend that you configure this group last, after all other configuration data has been loaded.

Function Prompts

Set up Group	Function Prompt	7-Segment Code	Default Value	Selection or Range of Setting	7-Segment Code	Parameter Definition
Top Display		Upper Display		Lower Display		
Tune Para	P	P	1	0.001 ~ 1000		PID gain.
	I	I	10	0 ~ 3200s		Integral coefficient of PID
	D	D	0	0 ~ 999s		Differential coefficient of PID

3.7 ALARM Set Up Group

Introduction

An alarm is an indication that an event that you have configured (for example—Process Variable) has exceeded one or more alarm limits. There is one alarm available for EDC201. There are two alarms available for EDC202 and EDC203. Each alarm has two Set Points. You can configure each of these two Set Points to alarm on various controller parameters.

There are two alarm output selections, High and Low. You can configure each Set Point to alarm either High or Low. These are called single alarms.

You can also configure the two Set Points to alarm on the same event and to alarm both high and low. A single adjustable Hysteresis of 0 % to 100 % is configurable for the alarm Set Point.

The prompts for the Alarm Outputs appear whether or not the alarm relays are physically present. This allows the Alarm status to be shown on the display.

Function Prompts

Set up Group	Function Prompt	7-Segment Code	Default Value	Selection or Range of Setting	7-Segment Code	Parameter Definition
	Top Display	Upper Display		Lower Display		
Alarms	11TYPE	RL !!	None	None	none	NO ALARM
				PV	PV	PROCESS VARIABLE
				DEV	DEV	DEVIATION
				Output	OUT	OUTPUT
				MANUAL	MAN	ALARM ON MANUAL MODE
				PV RATE	PVt	PV RATE OF CHANGE
				DIG INP	DI IN	DIGITAL INPUT
				TCWARN	TCW	THERMOCOUPLE WARNING
				TCFAIL	TCF	THERMOCOUPLE FAILING
				FSAFE	FS	FAILSAFE
	Diagnostic	DI AG	SYSTEM DIAGNOSTIC			
	11SEL	SE !!		HIGH	HI	HIGH ALARM
			LOW	LO	LOW ALARM	

Set up Group	Function Prompt	7-Segment Code	Default Value	Selection or Range of Setting	7-Segment Code	Parameter Definition
Top Display		Upper Display		Lower Display		
	11VAL	8L 11				ALARM 11 SET POINT VALUE
	12TYPE	8L 12	None	None	ନିର୍ଦ୍ଦେଶ	NO ALARM
				PV	୧୪	PROCESS VARIABLE
				DEV	୧୧୪	DEVIATION
				Output	୦୬୧	OUTPUT
				MANUAL	ନିର୍ଦ୍ଦେଶ	ALARM ON MANUAL MODE
				PV RATE	୧୪୧୧	PV RATE OF CHANGE
				DIG INP	୧୧ ୩	DIGITAL INPUT
				TCWARN	୧୧୧୩	THERMOCOUPLE WARNING
				TCFAIL	୧୧୧୪	THERMOCOUPLE FAILING
				FSAFE	୧୧୧	FAILSAFE
				Diagnostic	୧୧ ୩୦	SYSTEM DIAGNOSTIC
	12SEL	୧୧ 12		HIGH	୩୧	HIGH ALARM
				LOW	୪୦	LOW ALARM
	12VAL	8L 12				ALARM 12 SET POINT VALUE
	21TYPE	8L 21		None	ନିର୍ଦ୍ଦେଶ	This configuration is not available on EDC201.
				PV	୧୪	PROCESS VARIABLE. This configuration is not available on EDC201.
				DEV	୧୧୪	DEVIATION. This configuration is not available on EDC201.

3. Configuration
3.7. ALARM Set Up Group

Set up Group	Function Prompt	7-Segment Code	Default Value	Selection or Range of Setting	7-Segment Code	Parameter Definition
Top Display		Upper Display		Lower Display		
				Output	<i>0Ut</i>	This configuration is not available on EDC201.
				MANUAL	<i>MAN</i>	ALARM ON MANUAL MODE. This configuration is not available on EDC201.
				PV RATE	<i>PVt</i>	PV RATE OF CHANGE. This configuration is not available on EDC201.
				DIG INP	<i>dIn</i>	DIGITAL INPUT This configuration is not available on EDC201.
				TCWARN	<i>tCwN</i>	THERMOCOUPLE WARNING This configuration is not available on EDC201.
				TCFAIL	<i>tCFu</i>	THERMOCOUPLE FAILING This configuration is not available on EDC201.
				FSAFE	<i>F5</i>	FAILSAFE. This configuration is not available on EDC201.
				Diagnostic	<i>d! R0</i>	SYSTEM DIAGNOSTIC This configuration is not available on EDC201.
	21SEL	<i>5E2 1</i>		HIGH	<i>H!</i>	HIGH ALARM This configuration is not available on EDC201.
				LOW	<i>L0</i>	LOW ALARM. This configuration is not available on EDC201.

Set up Group	Function Prompt	7-Segment Code	Default Value	Selection or Range of Setting	7-Segment Code	Parameter Definition
Top Display		Upper Display		Lower Display		
	21VAL	୪୯୨୮				Alarm 21 Set Point value. This configuration is not available on EDC201.
	22TYPE	୫୯୨୨		None	ନିର୍ଦ୍ଦେଶ	NO ALARM. This configuration is not available on EDC201.
				PV	୧୫	This configuration is not available on EDC201.
				DEV	୧୧୫	DEVIATION. This configuration is not available on EDC201.
				Output	୦୧୧	OUTPUT. This configuration is not available on EDC201.
				MANUAL	୩୫୩	ALARM ON MANUAL MODE. This configuration is not available on EDC201.
				PV RATE	୧୫୫୧	PV RATE OF CHANGE. This configuration is not available on EDC201.
				DIG INP	୧୮୩	DIGITAL INPUT. This configuration is not available on EDC201.
				TCWARN	୧୧୫୩	THERMOCOUPLE WARNING. This configuration is not available on EDC201.
				TCFAIL	୧୧୫୧	THERMOCOUPLE FAILING. This configuration is not available on EDC201.
				FSAFE	୧୫	FAILSAFE. This configuration is not available on EDC201.

3. Configuration
3.7. ALARM Set Up Group

Set up Group	Function Prompt	7-Segment Code	Default Value	Selection or Range of Setting	7-Segment Code	Parameter Definition
Top Display		Upper Display		Lower Display		
				Diagnostic	<i>d! R0</i>	SYSTEM DIAGNOSTIC. This configuration is not available on EDC201.
	22SEL	<i>5E22</i>		HIGH	<i>H!</i>	HIGH ALARM. This configuration is not available on EDC201.
				LOW	<i>L0</i>	LOW ALARM. This configuration is not available on EDC201.
	22VAL	<i>8L22</i>		-	-	ALARM 22 SET POINT VALUE. This configuration is not available on EDC201.
	ALHYST	<i>H45R</i>	1%	0-100% OF SPAN		ALARM HYSTERESIS—A single adjustable hysteresis is provided on alarms such that when the alarm is OFF it activates at exactly the alarm Set Point; when the alarm is ON, it will not deactivate until the variable is 0.0 % to 100 % away from the alarm Set Point.
	ALARM DELAY	<i>dL4R</i>	0	0 ~ 30s		Configurable alarm trigger delay time allows you to force the trigger time of an alarm to delay for a time period of from 0 to 30 seconds in an alarm condition.

Set up Group	Function Prompt	7-Segment Code	Default Value	Selection or Range of Setting	7-Segment Code	Parameter Definition
Top Display		Upper Display		Lower Display		
	LATCH SEL	LATCH	LATCH	Yes/ No		Alarm output is configured to be Latching. When the alarm condition disappears, an acknowledge signal is needed to reset the alarm status.
		NoLATCH	NoLATCH			Alarm output is configured to be Non-latching. When an alarm condition is met, the alarm is triggered; when the alarm condition is cleared, the alarm is automatically reset.
	BLOCK		DISABLE	DISABLE	d! 5b	Disables alarm blocking
				ALARM1	ALARM1	Blocks Alarm 1 only.
				ALARM2	ALARM2	Blocks Alarm 2 only. This configuration is not available on EDC201.
				ALARM12	ALARM12	Blocks both alarms. This configuration is not available on EDC201.
	TIMER		Disable	DISABLE	d! 5b	Disable the timer.
				ENABLE	ERbL	Enable the timer.
	START	START	KEY	KEY	KEY	START allows you to select whether the timer starts with the keyboard (A/M OK key). This configuration is not available on EDC201.

3. Configuration

3.7. ALARM Set Up Group

Set up Group	Function Prompt	7-Segment Code	Default Value	Selection or Range of Setting	7-Segment Code	Parameter Definition
Top Display		Upper Display		Lower Display		
				ALARM2	<i>ALARM2</i>	START allows you to select whether the timer starts with the Alarm 2. This configuration is not available on EDC201.
	PERIOD	<i>PERI</i>		0:00min ~ 9:59hrs		PERIOD allows you to configure the length of the timeout period (from 0 to 9 hours:59 minutes).

3.8 Auxiliary Set Up Group

Introduction

The Auxiliary group lets you configure the Auxiliary Output to be a specific selection with desired scaling.

Accutune III automatically calculates GAIN, RATE, and RESET TIME (PID) tuning constants for your control loop. When initiated on demand, the Accutune algorithm measures a process step response and automatically generates the PID tuning constants needed for no overshoot on your process. It operates with PIDA, PIDB, PD+MR and Three Position Step Control Algorithm.

Function Prompts

Set up Group	Function Prompt	7-Segment Code	Default Value	Selection or Range of Setting	7-Segment Code	Parameter Definition
Auxiliary	DIG IN	<i>d1 n</i>	None	NONE	<i>n0nE</i>	NO DIGITAL INPUT SELECTIONS
				A M	<i>A M</i>	Switch Automatic /Manual operating mode.
				Direction	<i>d1 t</i>	The controller will scan the current action direction and redirect to the opposite direction.
				LOCK	<i>u0E</i>	KEYBOARD LOCKOUT. Contact closure disables all keys.
				Timer	<i>t n t</i>	The timer is started once the rising-edge of a digital input is detected.
				ACK	<i>A E</i>	Alarm acknowledgement configuration. The system acknowledges the alarm once the rising edge of digital input is detected.
			AT	<i>A t</i>	ON/OFF the ACCUTUNE. If the rising-edge of a digital input is detected, the system will start Accutune if the start condition has been met and Accutune is not running.	
	ACCUTUNE	<i>A t</i>	Disable	DISABLE	<i>d1 5b/ t u n E</i>	Disables the Accutune function.



3.9 OPTION Set Up Group

Introduction

This group includes selections for Decimal place, Units of temperature, Power frequency, system status, lockout attribute, operating level and password.

Function Prompts

Set up Group	Function Prompt	7-Segment Code	Default Value	Selection or Range of Setting	7-Segment Code	Parameter Definition
Top Display		Upper Display		Lower Display		
Option	PWR FREQ	HĒ	50 HZ	50HZ	50HĒ	Power Frequency
				60HZ	60HĒ	Power Frequency
	DECIMAL	dĒĒ!	None	None	none	No Decimal Place
				One	!	1 decimal place. ATTENTION Auto-ranging will occur for selections of one, two or three decimal places. For example, should the instrument be configured for two decimal places and the PV exceeds 99.99, then the display will change to a single decimal place so that values of 100.0 and above can be shown.
				Two	2	2 decimal places. ATTENTION Auto-ranging will occur for selections of one, two or three decimal places. For example, should the instrument be configured for two decimal places and the PV exceeds 99.99, then the display will change to a single decimal place so that values of 100.0 and above can be shown.

Set up Group	Function Prompt	7-Segment Code	Default Value	Selection or Range of Setting	7-Segment Code	Parameter Definition
Top Display		Upper Display		Lower Display		
				Three	3	3 decimal places. ATTENTION Auto-ranging will occur for selections of one, two or three decimal places. For example, should the instrument be configured for two decimal places and the PV exceeds 99.99, then the display will change to a single decimal place so that values of 100.0 and above can be shown.
TEMP UNIT	UNIT	DEG C	DEG C	DEG C	dEGC	Degrees Celsius
						DEG F
STATUS	StR			Firmware Version	FyBn	Firmware version.
				Hardware Version	HyBn	Hardware version.
				Error Code	E+Cd	Error code.
				Display Test	EESt	Testing LED display.
				Reset to Factory Default	dEFt	Restoring the configuration of the instrument back to the Factory Settings.
LOCKOUT	LOCKt	None	None	None	nONE	Disable the Lockout function.
				All but SP	El : SP	Lock all keys except  or  which is used for editing SP.

3. Configuration
 3.9. OPTION Set Up Group

Set up Group	Function Prompt	7-Segment Code	Default Value	Selection or Range of Setting	7-Segment Code	Parameter Definition
Top Display		Upper Display		Lower Display		
				ALL	<i>RLU</i>	Contact closure disables all keys for operator level. Lower display shows LOCK if a key is pressed. Long press Setup key and input the Configurator level password to unlock keys.
	OPERATING LEVEL	<i>OPUH</i>	None	Oper	<i>OPER</i>	Operator level.
				CFG	<i>CFG</i>	Configuration level.
				Mask	<i>MSK</i>	Customizing parameter mask. Determine the hide/unhide and configurable/unconfigurable features for different operation levels.
	PASSWORD	<i>PASS</i>		Oper	<i>OPER</i>	Setting the operator level password.
				Config	<i>CFG</i>	Setting the configuration level password.

Table 3-1: Set Up Parameter Reference

3.10 Configuring Analog Input













Configuring TC Type Input

This section describes the procedure of configuring TC Type Input, including Input Type, Input Ranges, Bias, Ratio and Filter.

Preliminary Steps

- The controller is in the Configuration Mode.
- The user has the access to set parameters.

Procedure

Step	Action	Press	Result
1	Select 'Input Type(TYPE)' Function Parameter	Long press 	Top Display= INP (This is the first Set Up Group title) Upper Display= TYPE
2	Select the intended TC Type	 or 	Lower Display=intended TC Type
3	Select 'High Range(Rhi)' Function Parameter		Upper Display= R_{HI} Lower Display= the current value of TC High Range Acknowledge the Value
4	Select 'Low Range(Rlow)' Function Parameter		Upper Display= R_{LO} Lower Display= the current value of TC Low Range Acknowledge the Value
5	Select 'Input Ratio(RATIO)' Function Parameter (if applicable)		Upper Display= RATIO Lower Display= the current value of TC Input Ratio
6	Change the Input Ratio Value (if applicable)	 or 	-
7	Select 'Input Bias(BIAS)' Function Parameter (if applicable)		Upper Display= BIAS Lower Display= the current value of TC Input Bias
8	Change the Input Bias Value (if applicable)	 or 	-
9	Select 'Filter(FILTER)' Function Parameter (if applicable)		Upper Display= FILTER Lower Display= the current value of TC Input Filter
10	Exit Configuration	Long press  or without any key operation more than 30s.	The controller exits Configuration Mode and returns to the Normal Operation Mode.

3. Configuration

3.10. Configuring Analog Input













Configuring RTD Type Input

This section describes the procedure of configuring RTD Type Input, including Input Type, Input Ranges, Bias, Ratio and Filter.

Preliminary Steps

- The controller is in the Configuration Mode.
- The user has the access to set parameters.

Procedure

Step	Action	Press	Result
1	Select 'Input Type(<i>TYPE</i>)' Function Parameter	Long press 	Top Display= INP (This is the first Set Up Group title) Upper Display= <i>TYPE</i>
2	Select the intended RTD Type	 or 	Lower Display= <i>100</i> or <i>100L</i>
3	Select 'High Range(Rhi)' Function Parameter		Upper Display= <i>RH</i> Lower Display= the current value of RTD High Range Acknowledge the Value
4	Select 'Low Range(Rlow)' Function Parameter		Upper Display= <i>RL</i> Lower Display= the current value of RTD Low Range Acknowledge the Value
5	Select 'Input Ratio(<i>RATIO</i>)' Function Parameter (if applicable)		Upper Display= <i>RAT</i> Lower Display= the current value of RTD Input Ratio
6	Change the Input Ratio Value (if applicable)	 or 	-
7	Select 'Input Bias(<i>BIAS</i>)' Function Parameter (if applicable)		Upper Display= <i>BIAS</i> Lower Display= the current value of RTD Input Bias
8	Change the Input Bias Value (if applicable)	 or 	-
9	Select 'Filter(<i>FILT</i>)' Function Parameter (if applicable)		Upper Display= <i>FILT</i> Lower Display= the current value of RTD Input Filter
10	Exit Configuration	Long press  or without any key operation more than 30s.	The controller exits Configuration Mode and returns to the Normal Operation Mode.

Configuring Analog Input Burnout













This section describes the procedure of configuring Burnout Mode for Analog Input.

Preliminary Steps

- The controller is in the Configuration Mode.
- The user has the access to set parameters.

Procedure





Configuring FailSafe Mode

Step	Action	Press	Result
1	Enter Set Up Mode	Long press 	Top Display= INP (This is the first Set Up Group title) Upper Display= <i>LYPE</i>
2	Select 'Burnout(<i>btfl</i>)' Function Parameter		Upper Display= <i>btfl</i> Lower Display= the current Burnout mode
3	Select 'FS(<i>F5</i>)' Function Parameter	 or 	Lower Display= <i>F5</i>
4	Select Control Set Up Mode		Top Display= CON
5	Select 'Failsafe(<i>FL5F</i>)' Function Parameter		Upper Display= <i>FL5F</i>
6	Change the Failsafe value (if applicable)	 or 	Lower Display= intended Failsafe value
7	Select 'Failsafe Mode' Function Parameter		Upper Display= <i>FLmd</i>
8	Change the Failsafe Mode value (if applicable)	 or 	Lower Display= <i>LR</i> or <i>RR</i>
9	Exit Configuration	Long press  or without any key operation more than 30s.	The controller exits Configuration Mode and returns to the Normal Operation Mode.





3. Configuration

3.10. Configuring Analog Input





Configuring No FailSafe Mode

Step	Action	Press	Result
1	Enter Set Up Mode	Long press 	Top Display= INP (This is the first Set Up Group title) Upper Display= UPP
2	Select 'Burnout(<i>bfn</i>)' Function Parameter		Upper Display= <i>bfn</i> Lower Display= the current Burnout mode
3	Select 'No Failsafe(<i>nofs</i>)' Function Parameter	 or 	Lower Display= <i>nofs</i>
4	Exit Configuration	Long press  or without any key operation more than 30s.	The controller exits Configuration Mode and returns to the Normal Operation Mode.

Configuring Upscale Burnout Mode

Step	Action	Press	Result
1	Enter Set Up Mode	Long press 	Top Display= INP (This is the first Set Up Group title) Upper Display= UPP
2	Select 'Burnout(<i>bfn</i>)' Function Parameter		Upper Display= <i>bfn</i> Lower Display= the current Burnout mode
3	Select 'Upscale Burnout(<i>usp</i>)' Function Parameter	 or 	Lower Display= <i>usp</i>
4	Exit Configuration	Long press  or without any key operation more than 30s.	The controller exits Configuration Mode and returns to the Normal Operation Mode.

Configuring Downscale Burnout Mode

Step	Action	Press	Result
1	Enter Set Up Mode	Long press 	Top Display= INP (This is the first Set Up Group title) Upper Display= $\pm YPE$
2	Select 'Burnout($b\pm n$)' Function Parameter		Upper Display= $b\pm n$ Lower Display= the current Burnout mode
3	Select 'Downscale Burnout($d0\pm n$)' Function Parameter	 or 	Lower Display= $d0\pm n$
4	Exit Configuration	Long press  or without any key operation more than 30s.	The controller exits Configuration Mode and returns to the Normal Operation Mode.







Assign Temperature Unit

This section describes the procedure of configuring Temperature Unit.

Preliminary Steps

- The controller is in the Configuration Mode.
- The user has the access to set parameters.

Procedure

Step	Action	Press	Result
1	Enter Set Up Mode	Long press 	Top Display= INP (This is the first Set Up Group title) Upper Display= $\pm YPE$
2	Select Option Set Up Mode		Top Display= OPT
3	Select 'Temp Unit ($un\ \pm$)' Function Parameter		Upper Display= $un\ \pm$
4	Change the 'Temp Unit' value	 or 	Lower Display= intended Temp Unit
5	Exit Configuration	Long press  or without any key operation more than 30s.	The controller exits Configuration Mode and returns to the Normal Operation Mode.

3. Configuration

3.11. Configuring Control Algorithm

3.11 Configuring Control Algorithm











Configuring ON-OFF Control

This section describes the procedure of configuring Control Algorithm.

Preliminary Steps

- The controller is in the Configuration Mode.
- The user has the access to set parameters.

Procedure

Step	Action	Press	Result
1	Enter Set Up Mode	Long press 	Top Display= INP (This is the first Set Up Group title) Upper Display= <i>t YPE</i>
2	Select Control Set Up Group		Top Display= CON Upper Display= <i>RUGC</i>
3	Select the ON-OFF Value		Lower Display= <i>ONFF</i>
4	Select the 'Output Hysteresis(<i>HYS</i>)' Function Parameter		Upper Display= <i>HYS</i>
5	Change the 'Output Hysteresis' Value	 or 	Lower Display=intended Output Hysteresis Value
6	Select the 'Minimum On Time (<i>Min On</i>)' Function Parameter		Upper Display= <i>Min On</i>
7	Change the 'Minimum On Time' Value	 or 	Lower Display=intended Minimum On Time Value
8	Select the 'Relay State(<i>Rel St</i>)' Function Parameter		Upper Display= <i>Rel St</i>
9	Change the 'Relay State' Value	 or 	Lower Display=intended Relay State Value
10	Exit Configuration	Long press  or without any key operation more than 30s.	The controller exits Configuration Mode and returns to the Normal Operation Mode.















Configuring Time Proportion Control

This section describes the procedure of configuring Time Proportion Control.

Preliminary Steps

- The controller is in the Configuration Mode.
- The user has the access to set parameters.

Procedure

Step	Action	Press	Result
1	Enter Set Up Mode	Long press 	Top Display= INP (This is the first Set Up Group title) Upper Display= EYP
2	Select Control Set Up Group		Top Display= CON Upper Display= RUC
3	Select Time A($\text{E} \bar{\text{R}}$) or Time B($\text{E} \bar{\text{b}}$) Value	 or 	Lower Display= $\text{E} \bar{\text{R}}$ or $\text{E} \bar{\text{b}}$
4	Select the 'Relay State(RUS)' Function Parameter		Upper Display= RUS
5	Change the 'Relay State' Value	 or 	Lower Display=intended Relay State Value
6	Select the 'Cycle Seconds (ESC)' Function Parameter		Upper Display= ESC
7	Change the 'Cycle Seconds' Value	 or 	Lower Display=intended Cycle Seconds Value
8	Select the 'Action (REN)' Function Parameter		Upper Display= REN
9	Change the 'Action' Value	 or 	Lower Display=intended Action Value
10	Exit Configuration	Long press  or without any key operation more than 30s.	The controller exits Configuration Mode and returns to the Normal Operation Mode.

3. Configuration

3.11. Configuring Control Algorithm















Configuring Three Position Step Control

This section describes the procedure of configuring Three Position Step Control.

Preliminary Steps

- The controller is in the Configuration Mode.
- The user has the access to set parameters.

Procedure

Step	Action	Press	Result
1	Enter Set Up Mode	Long press 	Top Display= INP (This is the first Set Up Group title) Upper Display= t_{YPE}
2	Select Control Set Up Group		Top Display= CON Upper Display= RUC
3	Select TPSC(t_{PSE}) Value	 or 	Lower Display= t_{PSE}
4	Select the 'Deadband(db)' Function Parameter		Upper Display= db
5	Change the 'Deadband' Value	 or 	Lower Display=intended Deadband Value
6	Select the 'Motor Time ($\bar{n}t_{t}$)' Function Parameter		Upper Display= $\bar{n}t_{t}$
7	Change the 'Motor Time' Value.	 or 	Lower Display=intended Motor Time Value
8	Select the 'Action ($Rctn$)' Function Parameter		Upper Display= $Rctn$
9	Change the 'Action' Value	 or 	Lower Display=intended Action Value
10	Exit Configuration	Long press  or without any key operation more than 30s.	The controller exits Configuration Mode and returns to the Normal Operation Mode













Configuring Soft Start

This section describes the procedure of configuring Soft Start function.

Preliminary Steps

- The controller is in the Configuration Mode.
- The user has the access to set parameters.

Procedure

Step	Action	Press	Result
1	Enter Set Up Mode	Long press 	Top Display= INP (This is the first Set Up Group title) Upper Display= Δ <i>SP</i>
2	Select Control Set Up Group		Top Display= CON Upper Display= <i>RLCC</i>
3	Select the 'Soft Start (<i>SSF</i>)' Function Parameter		Upper Display= <i>SSF</i>
4	Change the Soft Start Value	 or 	Lower Display=intended Soft Start Value
5	Select the Set Point (<i>SP</i>) Function Parameter		Upper Display= <i>SP</i>
6	Change the Set Point Value	 or 	Lower Display=intended Set Point Value
7	Select the Period (<i>PEP</i>) Function Parameter		Upper Display= <i>PEP</i>
8	Change the Period Value	 or 	Lower Display=intended Period Value
9	Exit Configuration	Long press  or without any key operation more than 30s.	The controller exits Configuration Mode and returns to the Normal Operation Mode.

3.12 Configuring Alarm

















Configuring PV Alarm



This section describes the procedure of configuring PV Alarm.

Preliminary Steps

- The controller is in the Configuration Mode.
- The user has the access to set parameters.

Procedure

Step	Action	Press	Result
1	Enter Set Up Mode	Long press 	Top Display= INP (This is the first Set Up Group title) Upper Display= <i>TYPE</i>
2	Select ALARM Set Up Group and Alarm Type Function Parameter	 > 	Top Display= ALM Upper Display= <i>AL 11</i> , <i>AL 12</i> , <i>AL 21</i> or <i>AL 22</i>
3	Select the 'PV (<i>PV</i>)'	 or 	Lower Display= <i>PV</i>
4	Select the 'High/Low Alarm (<i>SE 11</i> , <i>SE 12</i> , <i>SE 21</i> or <i>SE 22</i>)' Function Parameter		Upper Display= <i>SE 11</i> , <i>SE 12</i> , <i>SE 21</i> or <i>SE 22</i>
5	Change the 'High/Low Alarm' Value	 or 	Lower Display= <i>LO</i> or <i>HI</i>
6	Select the 'Alarm Set Point (<i>SL 11</i> , <i>SL 12</i> , <i>SL 21</i> , or <i>SL 22</i>)'		Upper Display= <i>SL 11</i> , <i>SL 12</i> , <i>SL 21</i> , or <i>SL 22</i>
7	Change the 'Alarm Set Point' Value	 or 	Lower Display=intended Alarm Set Point Value
8	Select the 'Alarm Hysteresis (<i>HYSA</i>)' Function Parameter		Upper Display= <i>HYSA</i>
9	Change the 'Alarm Hysteresis' Value	 or 	Lower Display=intended Alarm Hysteresis Value
10	Select the 'Alarm Delay (<i>ALYA</i>)' Function Parameter		Upper Display= <i>ALYA</i>
11	Change the 'Alarm Delay' Value	 or 	Lower Display=intended Alarm Delay Value
12	Select the 'Alarm Latch (<i>ALCH</i>)' Function Parameter		Upper Display= <i>ALCH</i>

Step	Action	Press	Result
13	Change the 'Alarm Latch' Value	 or 	Lower Display=intended Alarm Latch Value
14	Exit Configuration	Long press  or without any key operation more than 30s.	The controller exits Configuration Mode and returns to the Normal Operation Mode.















Configuring Deviation Alarm

This section describes the procedure of configuring Deviation Alarm.

Preliminary Steps











- The controller is in the Configuration Mode.
- The user has the access to set parameters.

Procedure

Step	Action	Press	Result
1	Enter Set Up Mode	Long press 	Top Display= INP (This is the first Set Up Group title) Upper Display= <i>TYPE</i>
2	Select ALARM Set Up Group and Alarm Type Function Parameter	 > 	Top Display= ALM Upper Display= <i>AL 11</i> or <i>AL 12</i>
3	Select the DEV (<i>dEB</i>) DEV (<i>dEB</i>)	 or 	Lower Display= <i>dEB</i>
4	Select the High/Low Alarm (<i>SE 11</i> , <i>SE 12</i> , <i>SE 21</i> or <i>SE 22</i>) Function Parameter		Upper Display= <i>SE 11</i> , <i>SE 12</i> , <i>SE 21</i> or <i>SE 22</i>
5	Change the High/Low Alarm Value	 or 	Lower Display= <i>LO</i> or <i>HI</i>
6	Select the Alarm Set Point (<i>SL 11</i> , <i>SL 12</i> , <i>SL 21</i> , or <i>SL 22</i>)		Upper Display= <i>SL 11</i> , <i>SL 12</i> , <i>SL 21</i> , or <i>SL 22</i>
7	Change the Alarm Set Point Value	 or 	Lower Display=intended Alarm Set Point Value
8	Select the Alarm State (<i>AN 11</i> or <i>AN 12</i>) Function Parameter (<i>AN 11</i> or <i>AN 12</i>)		Upper Display= <i>AN 11</i> or <i>AN 12</i>
9	Change the Alarm State Value	 or 	Lower Display=intended High or Low Alarm Value

3. Configuration

3.12. Configuring Alarm

Step	Action	Press	Result
10	Select the Alarm Hysteresis (<i>HYSR</i>) Function Parameter		Upper Display= <i>HYSR</i>
11	Change the Alarm Hysteresis Value	 or 	Lower Display=intended Alarm Hysteresis Value
12	Select the Alarm Delay (<i>DLDR</i>) Function Parameter		Upper Display= <i>DLDR</i>
13	Change the Alarm Delay Value	 or 	Lower Display=intended Alarm Delay Value
14	Select the Alarm Latch (<i>LRLH</i>) Function Parameter		Upper Display= <i>LRLH</i>
15	Change the Alarm Latch Value	 or 	Lower Display=intended Alarm Latch Value
16	Exit Configuration	Long press  or without any key operation more than 30s.	The controller exits Configuration Mode and returns to the Normal Operation Mode.





















Configuring Output Alarm

This section describes the procedure of configuring Output Alarm.

Preliminary Steps

- The controller is in the Configuration Mode.
- The user has the access to set parameters.

Procedure

Step	Action	Press	Result
1	Enter Set Up Mode	Long press 	Top Display= INP (This is the first Set Up Group title) Upper Display= <i>TYPE</i>
2	Select ALARM Set Up Group and 'Alarm Type' Function Parameter	 > 	Top Display= ALM Upper Display= <i>AL 11</i> or <i>AL 12</i>
3	Select the 'Output (<i>OUT</i>)'	 or 	Lower Display= <i>OUT</i>
4	Select the 'High/Low Alarm (<i>SE 11</i> , <i>SE 12</i> , <i>SE 21</i> or <i>SE 22</i>)' Function Parameter		Upper Display= <i>SE 11</i> , <i>SE 12</i> , <i>SE 21</i> or <i>SE 22</i>
5	Change the 'High/Low Alarm' Value	 or 	Lower Display= <i>LO</i> or <i>HI</i>
6	Select the 'Alarm State (<i>AN 11</i> or <i>AN 12</i>)' Function Parameter		Upper Display= <i>AN 11</i> or <i>AN 12</i>
7	Change the 'Alarm State' Value	 or 	Lower Display=intended High or Low Alarm Value
8	Select the 'Alarm Hysteresis (<i>HYSR</i>)' Function Parameter		Upper Display= <i>HYSR</i>
9	Change the 'Alarm Hysteresis' Value	 or 	Lower Display=intended Alarm Hysteresis Value
10	Select the 'Alarm Delay (<i>ALDR</i>)' Function Parameter		Upper Display= <i>ALDR</i>
11	Change the 'Alarm Delay' Value	 or 	Lower Display=intended Alarm Delay Value
12	Select the 'Alarm Latch (<i>ALCH</i>)' Function Parameter		Upper Display= <i>ALCH</i>
13	Change the 'Alarm Latch' Value	 or 	Lower Display=intended Alarm Latch Value

3. Configuration

3.12. Configuring Alarm

Step	Action	Press	Result
14	Exit Configuration	Long press SETUP or without any key operation more than 30s.	The controller exits Configuration Mode and returns to the Normal Operation Mode.











Configuring Manual Mode Alarm

This section describes the procedure of configuring Manual Mode Alarm.

Preliminary Steps

- The controller is in the Configuration Mode.
- The user has the access to set parameters.

Procedure

Step	Action	Press	Result
1	Enter Set Up Mode	Long press 	Top Display= INP (This is the first Set Up Group title) Upper Display=TYPE
2	Select ALARM Set Up Group and 'Alarm Type' Function Parameter		Top Display= ALM Upper Display= RL11 or RL12
3	Select the 'Manual Mode (MAN)'	 or 	Lower Display= MAN
4	Select the 'Alarm Delay (DLYR)' Function Parameter		Upper Display= DLYR
5	Change the 'Alarm Delay' Value	 or 	Lower Display=intended Alarm Delay Value
6	Select the 'Alarm Latch (LRCH)' Function Parameter		Upper Display= LRCH
7	Change the 'Alarm Latch' Value	 or 	Lower Display=intended Alarm Latch Value
8	Exit Configuration	Long press  or without any key operation more than 30s.	The controller exits Configuration Mode and returns to the Normal Operation Mode

3. Configuration
3.12. Configuring Alarm

















Configuring PV Rate of Change Alarm

This section describes the procedure of configuring PV Rate of Change Alarm.

Preliminary Steps

- The controller is in the Configuration Mode.
- The user has the access to set parameters.

Procedure

Step	Action	Press	Result
1	Enter Set Up Mode	Long press 	Top Display= INP (This is the first Set Up Group title) Upper Display= <i>TYPE</i>
2	Select ALARM Set Up Group and 'Alarm Type' Function Parameter		Top Display= ALM Upper Display= <i>RL 11</i> or <i>RL 12</i>
3	Select the 'PV Rate (<i>PVt</i>)'	 or 	Lower Display= <i>PVt</i>
4	Select the 'Alarm State (<i>RL 11</i> or <i>RL 12</i>)' Function Parameter		Upper Display= <i>RL 11</i> or <i>RL 12</i>
5	Change the 'Alarm State' Value	 or 	Lower Display=intended High or Low Alarm Value
6	Select the 'Alarm Hysteresis (<i>HYSR</i>)' Function Parameter		Upper Display= <i>HYSR</i>
7	Change the 'Alarm Hysteresis' Value	 or 	Lower Display=intended Alarm Hysteresis Value
8	Select the 'Alarm Delay (<i>DLDR</i>)' Function Parameter		Upper Display= <i>DLDR</i>
9	Change the 'Alarm Delay' Value	 or 	Lower Display=intended Alarm Delay Value
10	Select the 'Alarm Latch (<i>LARL</i>)' Function Parameter		Upper Display= <i>LARL</i>
11	Change the 'Alarm Latch' Value	 or 	Lower Display=intended Alarm Latch Value
12	Exit Configuration	Long press  or without any key operation more than 30s.	The controller exits Configuration Mode and returns to the Normal Operation Mode.

















Configuring Digital Input Alarm

This section describes the procedure of configuring Digital Input Alarm.

Preliminary Steps

- The controller is in the Configuration Mode.
- The user has the access to set parameters.

Procedure

Step	Action	Press	Result
1	Enter Set Up Mode	Long press 	Top Display= INP (This is the first Set Up Group title) Upper Display= <i>TYPE</i>
2	Select ALARM Set Up Group and 'Alarm Type' Function Parameter		Top Display= ALM Upper Display= <i>AL 11</i> or <i>AL 12</i>
3	Select the 'Digital Input (<i>dI 1</i>)'	 or 	Lower Display= <i>PBT</i>
4	Select the 'Alarm State (<i>AN 11</i> or <i>AN 12</i>)' Function Parameter		Upper Display= <i>AN 11</i> or <i>AN 12</i>
5	Change the 'Alarm State' Value	 or 	Lower Display=intended High or Low Alarm Value
6	Select the 'Alarm Hysteresis (<i>HYSA</i>)' Function Parameter		Upper Display= <i>HYSA</i>
7	Change the 'Alarm Hysteresis' Value	 or 	Lower Display=intended Alarm Hysteresis Value
8	Select the 'Alarm Delay (<i>ALYA</i>)' Function Parameter		Upper Display= <i>ALYA</i>
9	Change the 'Alarm Delay' Value	 or 	Lower Display=intended Alarm Delay Value
10	Select the 'Alarm Latch (<i>ALCH</i>)' Function Parameter		Upper Display= <i>ALCH</i>
11	Change the 'Alarm Latch' Value	 or 	Lower Display=intended Alarm Latch Value
12	Exit Configuration	Long press  or without any key operation more than 30s.	The controller exits Configuration Mode and returns to the Normal Operation Mode.

3. Configuration
 3.12. Configuring Alarm











Configuring TC Warning Alarm

This section describes the procedure of configuring TC Warning Alarm.

Preliminary Steps

- The controller is in the Configuration Mode.
- The user has the access to set parameters.

Procedure

Step	Action	Press	Result
1	Enter Set Up Mode	Long press 	Top Display= INP (This is the first Set Up Group title) Upper Display= <i>TYPE</i>
2	Select ALARM Set Up Group and Alarm Type Function Parameter		Top Display= ALM Upper Display= <i>AL 11</i> or <i>AL 12</i>
3	Select the TC Warning (<i>TCW</i>)	 or 	Lower Display= <i>TCW</i>
4	Select the Alarm Delay (<i>ALDR</i>) Function Parameter		Upper Display= <i>ALDR</i>
5	Change the Alarm Delay Value	 or 	Lower Display=intended Alarm Delay Value
6	Select the Alarm Latch (<i>ALCH</i>) Function Parameter		Upper Display= <i>ALCH</i>
7	Change the Alarm Latch Value	 or 	Lower Display=intended Alarm Latch Value
8	Exit Configuration	Long press  or without any key operation more than 30s.	The controller exits Configuration Mode and returns to the Normal Operation Mode.











Configuring TC Failing Alarm

This section describes the procedure of configuring TC Fail Alarm.

Preliminary Steps

- The controller is in the Configuration Mode.
- The user has the access to set parameters.

Procedure

Step	Action	Press	Result
1	Enter Set Up Mode	Long press 	Top Display= INP (This is the first Set Up Group title) Upper Display=TYPE
2	Select ALARM Set Up Group and 'Alarm Type' Function Parameter		Top Display= ALM Upper Display= RL11 or RL12
3	Select the 'TC Fail (TEFL)'	 or 	Lower Display= TEFL
4	Select the 'Alarm Delay (ALYR)' Function Parameter		Upper Display= ALYR
5	Change the 'Alarm Delay' Value	 or 	Lower Display=intended Alarm Delay Value
6	Select the 'Alarm Latch (LRCH)' Function Parameter		Upper Display= LRCH
7	Change the 'Alarm Latch' Value	 or 	Lower Display=intended Alarm Latch Value
8	Exit Configuration	Long press  or without any key operation more than 30s.	The controller exits Configuration Mode and returns to the Normal Operation Mode

3. Configuration
 3.12. Configuring Alarm











Configuring Failsafe Alarm

This section describes the procedure of configuring Failsafe Alarm.

Preliminary Steps

- The controller is in the Configuration Mode.
- The user has the access to set parameters.

Procedure

Step	Action	Press	Result
1	Enter Set Up Mode	Long press 	Top Display= INP (This is the first Set Up Group title) Upper Display= <i>t YPE</i>
2	Select ALARM Set Up Group and 'Alarm Type' Function Parameter		Top Display= ALM Upper Display= <i>RL I1</i> or <i>RL I2</i>
3	Select the 'Failsafe (F5)'	 or 	Lower Display= <i>F5</i>
4	Select the 'Alarm Delay (dLYR)' Function Parameter		Upper Display= <i>dLYR</i>
5	Change the 'Alarm Delay' Value	 or 	Lower Display=intended Alarm Delay Value
6	Select the 'Alarm Latch (LRCH)' Function Parameter		Upper Display= <i>LRCH</i>
7	Change the 'Alarm Latch' Value	 or 	Lower Display=intended Alarm Latch Value
8	Exit Configuration	Long press  or without any key operation more than 30s.	The controller exits Configuration Mode and returns to the Normal Operation Mode.











Configuring Diagnostic Alarm

This section describes the procedure of configuring Diagnostic Alarm.

Preliminary Steps

- The controller is in the Configuration Mode.
- The user has the access to set parameters.

Procedure

Step	Action	Press	Result
1	Enter Set Up Mode	Long press 	Top Display= INP (This is the first Set Up Group title) Upper Display=TYPE
2	Select ALARM Set Up Group and Alarm Type Function Parameter		Top Display= ALM Upper Display= RL 11 or RL 12
3	Select the 'Diagnostic (dI RC)'	 or 	Lower Display= dI RC
4	Select the 'Alarm Delay (dL YR)' Function Parameter		Upper Display= dL YR
5	Change the 'Alarm Delay' Value	 or 	Lower Display=intended Alarm Delay Value
6	Select the 'Alarm Latch (LRCH)' Function Parameter		Upper Display= LRCH
7	Change the 'Alarm Latch' Value	 or 	Lower Display=intended Alarm Latch Value
8	Exit Configuration	Long press  or without any key operation more than 30s.	The controller exits Configuration Mode and returns to the Normal Operation Mode.

3. Configuration
 3.12. Configuring Alarm









Assign Alarm Hysteresis

This section describes the procedure of configuring Alarm Hysteresis.

Preliminary Steps

- The controller is in the Configuration Mode.
- The user has the access to set parameters.
- Alarm Type selected support hysteresis assignment.

Procedure

Step	Action	Press	Result
1	Enter Set Up Mode	Long press 	Top Display= INP (This is the first Set Up Group title) Upper Display= <i>TYPE</i>
2	Select ALARM Set Up Group and 'Alarm Type' Function Parameter		Top Display= ALM Upper Display= <i>AL 11</i> or <i>AL 12</i>
3	Select the 'Alarm Type'	 or 	Lower Display= intended Alarm Type Value
4	Select the 'Alarm Hysteresis (<i>HYSR</i>)' Function Parameter		Upper Display= <i>HYSR</i>
5	Change the 'Alarm Hysteresis' Value	 or 	Lower Display=intended Alarm Hysteresis Value
6	Exit Configuration	Long press  or without any key operation more than 30s.	The controller exits Configuration Mode and returns to the Normal Operation Mode.







Configuring Alarm Delay

This section describes the procedure of configuring Alarm Delay.

Preliminary Steps

- The controller is in the Configuration Mode.
- The user has the access to set parameters.

Procedure

Step	Action	Press	Result
1	Enter Set Up Mode	Long press 	Top Display= INP (This is the first Set Up Group title) Upper Display= <i>t YPE</i>
2	Select ALARM Set Up Group and 'Alarm Type' Function Parameter		Top Display= ALM Upper Display= <i>RL 11</i> or <i>RL 12</i>
3	Select the 'Alarm Delay (<i>dLdR</i>)' Function Parameter		Upper Display= <i>dLdR</i>
4	Change the 'Alarm Delay' Value	 or 	Lower Display=intended Alarm Delay Value
5	Exit Configuration	Long press  or without any key operation more than 30s.	The controller exits Configuration Mode and returns to the Normal Operation Mode.

3. Configuration
 3.12. Configuring Alarm







Configuring Alarm Latching

This section describes the procedure of configuring Alarm Latching.

Preliminary Steps

- The controller is in the Configuration Mode.
- The user has the access to set parameters.

Procedure

Step	Action	Press	Result
1	Enter Set Up Mode	Long press 	Top Display= INP (This is the first Set Up Group title) Upper Display= <i>TYPE</i>
2	Select ALARM Set Up Group and 'Alarm Type' Function Parameter		Top Display= ALM Upper Display= <i>AL 11</i> or <i>AL 12</i>
3	Select the 'Alarm Latch (<i>LATCH</i>)' Function Parameter		Upper Display= <i>LATCH</i>
4	Change the 'Alarm Latch' Value	 or 	Lower Display=intended Alarm Latch Value
5	Exit Configuration	Long press  or without any key operation more than 30s.	The controller exits Configuration Mode and returns to the Normal Operation Mode



Configuring Alarm Blocking



This section describes the procedure of configuring Alarm Blocking.

Preliminary Steps

- The controller is in the Configuration Mode.
- The user has the access to set parameters.

Procedure

Step	Action	Press	Result
1	Enter Set Up Mode	Long press 	Top Display= INP (This is the first Set Up Group title) Upper Display= <i>TYPE</i>
2	Select ALARM Set Up Group and 'Alarm Type' Function Parameter		Top Display= ALM Upper Display= <i>AL 11</i> or <i>AL 12</i>
3	Select the 'Alarm Blocking (<i>BLK</i>)' Function Parameter		Upper Display= <i>BLK</i>

Step	Action	Press	Result
4	Change the 'Alarm Blocking' Value	 or 	Lower Display=intended Alarm Blocking Value
5	Exit Configuration	Long press  or without any key operation more than 30s.	The controller exits Configuration Mode and returns to the Normal Operation Mode.









Configuring Timer

This section describes the procedure of configuring Timer.

Preliminary Steps

- The controller is in the Configuration Mode.
- The user has the access to set parameters.

Procedure

Step	Action	Press	Result
1	Enter Set Up Mode	Long press 	Top Display= INP (This is the first Set Up Group title) Upper Display= $tYPE$
2	Select ALARM Set Up Group and 'Alarm Type' Function Parameter		Top Display= ALM Upper Display= $AL 11$ or $AL 12$
3	Select the 'Timer ($t\bar{n}t$)' Function Parameter		Upper Display= $t\bar{n}t$
4	Select the 'ENABLE ($ERbL$)' Function Parameter		Lower Display= $ERbL$
5	Select the 'Period (PER)' Function Parameter		Upper Display= PER
6	Change the 'Period' Value	 or 	Lower Display=intended Timer Period Value
7	Exit Configuration	Long press  or without any key operation more than 30s.	The controller exits Configuration Mode and returns to the Normal Operation Mode

3.13 Configuring Digital Input





Disable DI Function

This section describes the procedure of disabling DI function.

Preliminary Steps

- The controller is in the Configuration Mode.
- The user has the access to set parameters.

Procedure

Step	Action	Press	Result
1	Enter Set Up Mode	Long press 	Top Display= INP (This is the first Set Up Group title) Upper Display= <i>TYPE</i>
2	Select AUX Set Up Group and 'Digital Input(<i>di</i>)' Function Parameter		Top Display= AUX Upper Display= <i>di</i>
3	Select NONE(<i>none</i>)	 or 	Lower Display= <i>none</i>
4	Exit Configuration	Long press  or without any key operation more than 30s.	The controller exits Configuration Mode and returns to the Normal Operation Mode.





Configuring DI as Control Mode Switch

This section describes the procedure of configuring DI as Control Mode Switch.

Preliminary Steps

- The controller is in the Configuration Mode.
- The user has the access to set parameters.

Procedure

Step	Action	Press	Result
1	Enter Set Up Mode	Long press 	Top Display= INP (This is the first Set Up Group title) Upper Display= t YPE
2	Select AUX Set Up Group and 'Digital Input($d' \bar{U}$)' Function Parameter		Top Display= AUX Upper Display= $d' \bar{U}$
3	Select Auto/MAN ($R\bar{n}$)	 or 	Lower Display= $R\bar{n}$
4	Exit Configuration	Long press  or without any key operation more than 30s.	The controller exits Configuration Mode and returns to the Normal Operation Mode.





Configuring DI as Control Direction Switch

This section describes the procedure of configuring DI as Control Direction Switch.

Preliminary Steps

- The controller is in the Configuration Mode.
- The user has the access to set parameters.

Procedure

Step	Action	Press	Result
1	Enter Set Up Mode	Long press 	Top Display= INP (This is the first Set Up Group title) Upper Display= t YPE
2	Select AUX Set Up Group and 'Digital Input($d' \bar{U}$)' Function Parameter		Top Display= AUX Upper Display= $d' \bar{U}$
3	Select Direction ($d' \bar{t}$)	 or 	Lower Display= $d' \bar{t}$
4	Exit Configuration	Long press  or without any key operation more than 30s.	The controller exits Configuration Mode and returns to the Normal Operation Mode.





Configuring DI as Keypad Locking Switch DI

This section describes the procedure of configuring DI as Keypad Locking Switch.

Preliminary Steps

- The controller is in the Configuration Mode.
- The user has the access to set parameters.

Procedure

Step	Action	Press	Result
1	Enter Set Up Mode	Long press 	Top Display= INP (This is the first Set Up Group title) Upper Display= $t\ yPE$
2	Select AUX Set Up Group and 'Digital Input($d\ i$)' Function Parameter		Top Display= AUX Upper Display= $d\ i$
3	Select LOCK (LDL)	 or 	Lower Display= LDL
4	Exit Configuration	Long press  or without any key operation more than 30s.	The controller exits Configuration Mode and returns to the Normal Operation Mode.





Configuring DI as Timer Initiating Trigger

This section describes the procedure of configuring DI as Timer Initiating Trigger.

Preliminary Steps

- The controller is in the Configuration Mode.
- The user has the access to set parameters.

Procedure

Step	Action	Press	Result
1	Enter Set Up Mode	Long press 	Top Display= INP (This is the first Set Up Group title) Upper Display= $t\ yPE$
2	Select AUX Set Up Group and 'Digital Input($d\ i$)' Function Parameter		Top Display= AUX Upper Display= $d\ i$
3	Select Timer ($t\ n\ t$)	 or 	Lower Display= $t\ n\ t$
4	Exit Configuration	Long press  or without any key operation more than 30s.	The controller exits Configuration Mode and returns to the Normal Operation Mode





Configuring DI as Alarm Acknowledging Switch

This section describes the procedure of configuring DI as Alarm Acknowledging.

Preliminary Steps

- The controller is in the Configuration Mode.
- The user has the access to set parameters.

Procedure

Step	Action	Press	Result
1	Enter Set Up Mode	Long press 	Top Display= INP (This is the first Set Up Group title) Upper Display= <i>TYPE</i>
2	Select AUX Set Up Group and Digital Input(<i>d# G</i>) Function Parameter		Top Display= AUX Upper Display= <i>d# G</i>
3	Select ACK (<i>ACK</i>)	 or 	Lower Display= <i>ACK</i>
4	Exit Configuration	Long press  or without any key operation more than 30s.	The controller exits Configuration Mode and returns to the Normal Operation Mode.

3. Configuration

3.13. Configuring Digital Input





Configuring DI as Auto Tuning Initiating Trigger

This section describes the procedure of configuring DI as AT Initiating Trigger.

Preliminary Steps

- The controller is in the Configuration Mode.
- The user has the access to set parameters.

Procedure

Step	Action	Press	Result
1	Enter Set Up Mode	Long press 	Top Display= INP (This is the first Set Up Group title) Upper Display= TYPE
2	Select AUX Set Up Group and 'Digital Input(di E)' Function Parameter		Top Display= AUX Upper Display= di E
3	Select AT (AT)	 or 	Lower Display= AT
4	Exit Configuration	Long press  or without any key operation more than 30s.	The controller exits Configuration Mode and returns to the Normal Operation Mode.

4. Monitoring and Operating the Controller

4.1 Overview

This section gives you all the information necessary to help you monitor and operate your controller including an Operator Interface overview, how to switch between normal operation mode and parameter configuration mode, setting the timer and monitoring the displays.

4.2 Operator Interface

Figure 4-1 and Figure 4-2 provide the view of the Operator Interfaces.

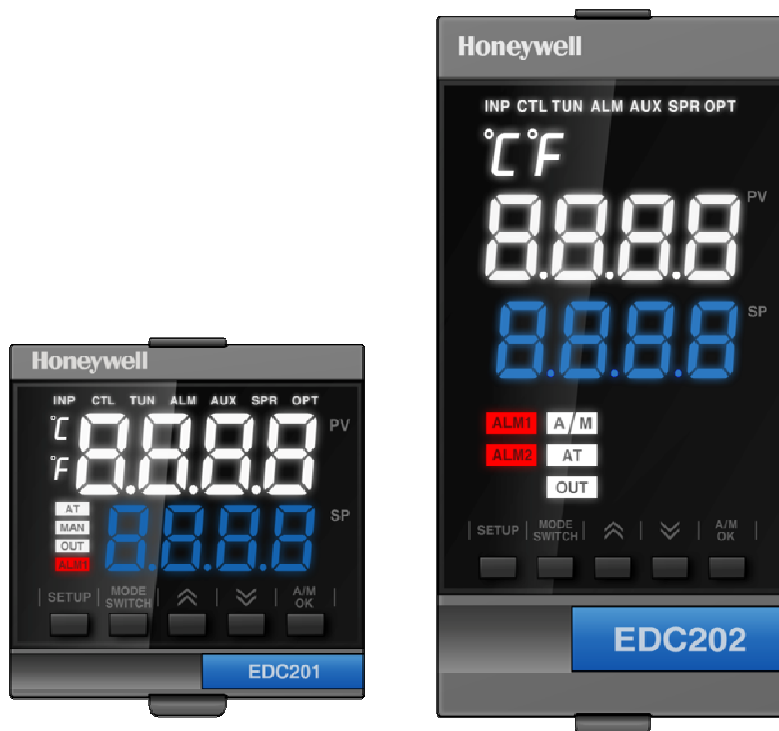

Figure 4-1: Operator Interface (EDC201, EDC202)

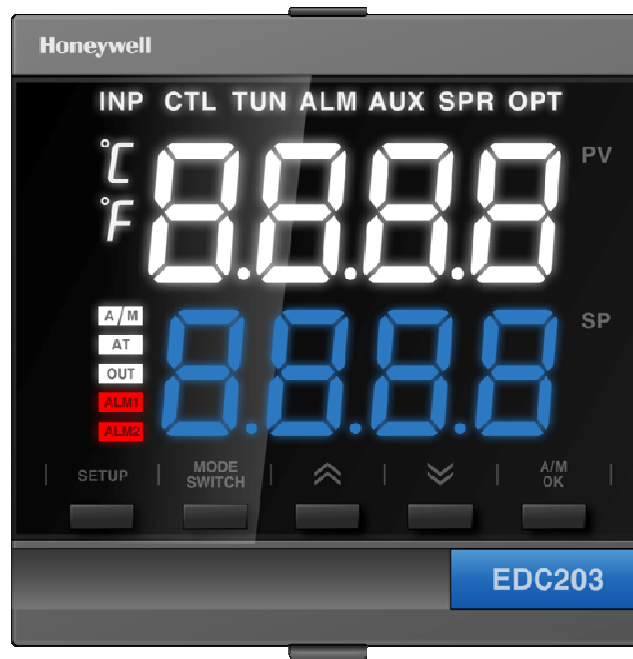

Figure 4-2 Operator Interface (EDC203)

4.3 Monitoring Your Controller

Annunciators

The following annunciator functions have been provided to help monitor the controller:

Annunciator	Indication
ALM1 2 3 4	A visual indication of each alarm
OUT1 2	A visual indication of the control relays
MAN	On: Manual Mode Off: Automatic Mode
AT	Accutuning in progress
[None], F or C	A visual indication of the temperature units [None]—No temperature unit annunciator F—Degrees Fahrenheit C—Degrees Celsius

Viewing the operating parameters

Press the LOWER DISPLAY key to scroll through the operating parameters listed in Table 4-1 Lower Display Key Parameter Prompts. The lower display will show only those parameters and their values that apply to your specific model.

Lower Display	7-Segment Code	Description
Tx.xx	EH, IIII	Time that remains on timer in Hours.Minutes.
Mxxx	niIIII	Output value is percent; for Three Position Step control, this is an estimated motor position and shown with no decimal place.
ASTR	RSLE+	When AT is enabled and AT process is not operating
ASTP	RSLEP	When AT is enabled and AT process is operating
ALM	RLn	Alarm is triggered and configured as Latch
Fail	FR, L	Failsafe — conditions for failsafe are: ... EEROM Test Failed ... Scratch Pad RAM Test Failed ... Configuration Test Failed ... Field or Factory Cal Test Failed

Table 4-1 Lower Display Key Parameter Prompts

Diagnostic Messages

The EDC 200 Series performs background tests to verify data and memory integrity. If there is a malfunction, a diagnostic message will be shown on the lower display. In the case of more than one simultaneous malfunction, only the highest priority diagnostic message will be displayed. Table 4-2: Diagnostic Messages shows the error messages in order of priority. If any of these diagnostic messages appear on the lower display, refer to *Chapter 5 Troubleshooting/ Service* for information on how to correct the problem.

Prompt	Description
LOCK	The lockout feature has been enabled to prevent unauthorized changes of certain functions or parameters.
EDxx	Power on error
FCxx	Configure and calibration check error
ECxx	IO control error

Table 4-2: Diagnostic Messages

4.4 Controller Mode

Operation Mode

Controller is typically running in two operation modes, normal operation mode and parameter configuration mode.

Mode Definitions

Operation Mode	Definition
Normal Operation	<p>In normal operation mode, the controller displays the PV, SP/Output.</p> <p>In this mode you can process the following:</p> <ul style="list-style-type: none">• Start /Stop the Auto Tuning process,• Switch between Manual Mode and Auto Mode. In Manual Mode, SP tracks PV. The operator directly controls the controller output level. In Auto Mode, you can adjust the Set Point.• Operate the Timer• View and acknowledge Failsafe and Alarms.
Parameter Configuration	<p>In the configuration mode, the configurator configures the function parameters in authorized Set up Groups and enter "Mask" mode.</p>

Control Mode









Mode Definitions

Control Mode	Definition
AUTOMATIC with LOCAL SET POINT	<p>In automatic local mode, the controller operates from the local Set Points and automatically adjusts the output to maintain the PV at the desired value.</p> <p>In this mode you can adjust the Set Point.</p>
Manual	<p>In Manual mode, the operator directly controls the controller output level. The process variable and the percent output are displayed. The configured High and Low Output Limits are disregarded and the operator can change the output value, using the increment and decrement keys, to the limits allowed by the output type (0 % to 100 % for a time proportioning output or -5 % to 105 % for a current output).</p>

4.5 Setting Operation Level

There are two operating levels for parameters, configurator level and operator level. You can set up or modify the operation level using the following procedure.









Procedure

Step	Action	Press	Result
1	Enter Set up Mode	Long press 	Top Display = OPT
2	OPTEnter operation level setting mode		Top Display = OPT
3			Upper Display= <i>OP_{LV}</i>
4	Set Operation level or configurator level	 or 	Lower Display= <i>OP_{LEV}/CFG</i>
5			Upper Display = <i>PR55</i> Lower Display = <i>0000</i>
6	Switch the digit		
7	Set the value		
8			Confirm the input value. <ul style="list-style-type: none"> • If the password is correct, return to normal operating mode. • If you enter the wrong password, return to Step 4.

4.6 Setting Operation Password

Change to operator or configurator level for authority management purpose or change the default password of operator and configurator level. The password of operator and configurator are both 0000. The configurator password can not be changed before the operator password is changed.

Procedure

Step	Action	Press	Result
1	Enter Set up Mode	Long press 	Top Display = OPT
2	Enter operation level setting mode		Top Display = OPT
3			Upper Display= PASS
4	Set Operation level or configurator level	 or 	Lower Display= OPER/CFG
5			Upper Display= OPER/CFG
6	Switch the digit		
7	Set the value		
8			Confirm the input value. <ul style="list-style-type: none"> • If the password is correct, return to normal operating mode. • If you enter the wrong password, return to Step 4.











4.7 Setting Parameter Mask

The parameter setting can be set to allow access or configuration by different operating levels.
Mask mode can only be entered in the configuration level without a password.

Preliminary Steps

The controller is in parameter configuration mode and the user has the access to set the parameters.

Procedure

Step	Action	Press	Result
1	Enter Set up Mode	Long press 	Top Display = OPT
2	Enter operation level setting mode		Top Display = OPT
3	Enter Mask Mode.		Upper Display=OPLV
4		 or 	Lower Display=MASK
5			Enter Set up Mode
6	Switch Set up parameter	 or 	Top Display= current Set up group Upper Display=current Set up parameter
7	Set Mask Value	 or 	Lower Display=Parameter Mask Value Note: 00: Hide the parameter; 10: Configurable only for configurator level, in this case, operator could view the value of the parameter but could not modify the value 11: Display the parameter and both Operator and Configurator level can configure the parameters.







4.8 Reseting to Factory Default

This section describes the procedure of resetting configuration to factory default settings.

Preliminary Steps

- The controller is in the Configuration Mode.
- The user has the access to set parameters.

Procedure

Step	Action	Press	Result
1	Enter Set Up Mode	Long press 	Top Display= INP (This is the first Set Up Group title) Upper Display= $t\ yPE$
2	Select OPT Set Up Group		Top Display= OPT Upper Display= $H\bar{E}$
3	Select Status($5tR$) Function Parameter		Upper Display= $5tR$
4	Select Reset to Display Test ($tESt$)	 or 	Lower Display= $tESt$ All the parameters are reset to factory default value
5	Exit Configuration	Long press  or without any key operation more than 30s.	The controller exits Configuration Mode and returns to the Normal Operation Mode.



4.9 Testing Display



This section describes the procedure of resetting to Testing Display.

Preliminary Steps

- The controller is in the Configuration Mode.
- The user has the access to set parameters.

Procedure

Step	Action	Press	Result
1	Enter Set Up Mode	Long press 	Top Display= INP (This is the first Set Up Group title) Upper Display= $t\ yPE$
2	Select OPT Set Up Group		Top Display= OPT Upper Display= $H\bar{E}$
3	Select Status($5tR$) Function Parameter		Upper Display= $5tR$

Step	Action	Press	Result
4	Select Reset to Display Test (tEtE)	 or 	Lower Display= tEtE All the LEDs on the screen are “on” to indicate the LED Status
5	Exit Configuration	Long press  or without any key operation more than 30s.	The controller exits Configuration Mode and returns to the Normal Operation Mode.





4.10 Setting Power Frequency

This section describes the procedure of setting Power Frequency.

Preliminary Steps

- The controller is in the Configuration Mode.
- The user has the access to set parameters.

Procedure

Step	Action	Press	Result
1	Enter Set Up Mode	Long press 	Top Display= INP (This is the first Set Up Group title) Upper Display= tYPE
2	Select OPT Set Up Group		Top Display= OPT Upper Display= HZ
3	Select Power Frequency (Hz)	 or 	Lower Display= Intended Power Frequency Value
4	Exit Configuration	Long press  or without any key operation more than 30s.	The controller exits Configuration Mode and returns to the Normal Operation Mode.







4.11 Setting Decimal Point Location

This section describes the procedure of setting Decimal Point Location.

Preliminary Steps

- The controller is in the Configuration Mode.
- The user has the access to set parameters.

Procedure

Step	Action	Press	Result
1	Enter Set Up Mode	Long press 	Top Display= INP (This is the first Set Up Group title) Upper Display= $t YPE$
2	Select OPT Set Up Group		Top Display= OPT Upper Display= $H\bar{E}$
3	Select the Decimal Place ($dECt$) Function Parameter		Upper Display= $dECt$
4	Select the Decimal Place value	 or 	Lower Display= Intended Decimal Place Value
5	Exit Configuration	Long press  or without any key operation more than 30s.	The controller exits Configuration Mode and returns to the Normal Operation Mode.



4.12 Examining Product Information



This section describes the procedure of examining the Product Information.

Preliminary Steps

- The controller is in the Configuration Mode.
- The user has the access to set parameters.

Procedure

Step	Action	Press	Result
1	Enter Set Up Mode	Long press 	Top Display= INP (This is the first Set Up Group title) Upper Display= $t YPE$
2	Select OPT Set Up Group		Top Display= OPT Upper Display= $H\bar{E}$
3	Select Status(StR) Function Parameter		Upper Display= StR

Step	Action	Press	Result
4	Select Firmware Version ($F1 \bar{t} \bar{n}$)	 or 	Lower Display= $F \bar{y} \bar{y} \bar{n}$
5	Enter the Selection		Upper Display= $F \bar{y} \bar{y} \bar{n}$ Lower Display=System Firmware Version

4.13 Acknowledge Alarms



Alarm can be set as No Latching or Latching.

- If Latching function is disabled, that is LACH=NO, the ALM LED lights up when alarm occurs and turns off when alarm disappears.
- If Latching function is enabled, that is LACH=YES, use the following procedure.

Preliminary Steps

- Latch function is enabled. In the Set Up Mode, LACH=YES.
- An alarm has been triggered. The Alarm LED keeps blinking when the alarm occurs. When the alarm is acknowledged, it will stop blinking if the alarm is still active or the LED turns off if the alarm disappears.

Procedure

Step	Action	Press	Result
1	Switch the lower display to show the alarm message.		Lower Display= $R \bar{u} \bar{n}$
2	Acknowledge the alarm.		If the alarm is still active, ALM LED= stops blinking; If alarm disappears, ALM LED=off.

4.14 Setting Auto Tuning







This section introduces the procedure of initiating Auto Tuning.

Initiating Auto Tuning

Preliminary Steps

The user has the access to set parameters.

Procedure

Step	Action	Press	Result
1	Enter Set Up Mode	Long press 	Top Display= INP (This is the first Set Up Group title) Upper Display= $t\ yPE$
2	Select AUX Set Up Group		Top Display= AUX Upper Display= $d\ i\ n$
3	Select ACCUTUNE (Rt) Function Parameter		Upper Display= Rt
4	Select Tune($t\ URtE$)	 or 	Lower Display= $t\ URtE$
5	Exit Configuration	Long press  or without any key operation more than 30s.	The controller exits Configuration Mode and returns to the Normal Operation Mode.

Starting Through Keypad

Preliminary Steps



The operating level of the controller is configurator level.

Current control selection is a PID. ALGC=Time A or Time B.

ACCUTUNE=TUNE Auto Tuning function is enabled. That is in configuration mode, ACCUTUNE= TUNE.

The controller is in Auto operation mode and MAN LED is off. Auto Tuning can not be started in Manual operation mode.

Procedure

Step	Action	Press	Result
1	In Normal Operation Mode, switch the lower display to show the status of Auto Tuning		Lower Display = ASTR <ul style="list-style-type: none"> If Auto Tuning is not running, lower display shows up ASTR; If Auto Tuning is running, lower display shows up ASTP. If Auto Tuning is running, lower display shows up ASTP.
2	Start Auto Tuning		Auto Tuning is started.



System detects the rising edge of the digital input and sends the command to start the Auto Tuning process. If the prerequisite of Auto Tuning is not met, the lower display will show up Error (E++) after short pressing, otherwise, the Auto Tuning process is started.

4. Monitoring and Operating the Controller
4.15. Switch Manual/Auto Mode

Stopping Auto Tuning

Preliminary Steps

Auto Tuning is started.

Procedure

Step	Action	Press	Result
1	In Normal Operation Mode, switch the lower display to show the status of Auto Tuning	MODE SWITCH	Lower Display = <i>Ret SP</i> <ul style="list-style-type: none"> If Auto Tuning is not running, lower display = <i>Ret SP</i>; If Auto Tuning is running, lower display = <i>Ret SP</i>. If Auto Tuning is running, lower display = <i>Ret SP</i>.
2	Stop Auto Tuning	A/M OK	Auto Tuning is stopped.

4.15 Switch Manual/Auto Mode

Preliminary Steps

The controller is in the Normal Operation Mode.

Procedure

Step	Action	Press	Result
1	Switch Manual / Auto Mode	A/M OK	Left Display = MAN is on or off <ul style="list-style-type: none"> In Auto Mode: MAN Led is off; In Manual Mode: MAN Led is on.

4.16 Setting SP











Preliminary Steps

In the automatic mode, Left Display= MAN LED off.

With setting level of SP value.

Procedure

Step	Action	Press	Result
1	In the lower display, select the SP value which needs to be set up.	MODE SWITCH	Lower Display= Current SP value of the system

- 2 Set SP value.  or 
- Lower Display= current set SP value
- Short press  or  to adjust the SP value;
 - Long press  or  to adjust the SP value;
 - Long press  or  and then short press  or  to adjust the stopped digit place.

4.17 Setting Timer

The Timer provides a configurable Time-out period of from 0 to 9 hours: 59 minutes. The Timer display is Time Remaining.

Viewing the Timer Current Status

Preliminary Steps

Timer is enabled. TMR= ENABLEPERI= In the Set up mode, TMR=ENABLE, PERI= the timer upper limit value.

Procedure

Step	Action	Press	Result
1	Switch to the timer output value.		Lower Display= <i>###. ###</i> <ul style="list-style-type: none"> • If the timer is ready to start, Lower Display=configurated Timer cycle. • If the timer is running, "T" logo flashes and remaining time is displayed. If the timer is timed-out, 0 is displayed.

Start Timer

Preliminary Steps

Timer is ready to start.

Procedure

Step	Action	Press	Result
1	Start the timer.		Lower Display = "T" logo flashes and remaining time is displayed.

4. Monitoring and Operating the Controller
4.18. Setting Output Value

Resetting Timer

Preliminary Steps

Timer is timed-out that is Lower Display = t 0.00.

Procedure

Step	Action	Press	Result
1	Reset the Timer.		Lower Display = t + set timer period

4.18 Setting Output Value



This section introduces the procedure of setting output value.

In Auto Mode

Preliminary Steps

In Normal Operation Mode, MAN LED is off and Lower Display= current PV value.

Procedure





Step	Action	Press	Result
1	Select SP		Lower Display= Current SP value
2	Change the SP Value or Selection	 or 	Lower Display = Intended SP value

AT is Processing

Preliminary Steps

In Normal Operation Mode, AT LED is on and Lower Display= current PV and SP value.

Procedure



Step	Action	Press	Result
1	Select PV or SP		Lower Display= Intended PV or SP current value
2	Select Manual Control Mode		MAN LED is on and AT LED is off
3	Change the PV/SP Value or Selection	 or 	Lower Display = Intended PV or SP value
4	Enter the Value or Selection		Enters value or selection made into memory after another key is pressed.

In Man Mode

Preliminary Steps

In Normal Operation Mode, Man LED is on and Upper Display= current PV Lower Display= SP.

Procedure

Step	Action	Press	Result
1	Select SP		Lower Display= ~! !! Upper Display= Intended PV current value
2	Change the Output Value	 or 	Lower Display=Intended Output value OUT LED blinks

5. Troubleshooting/Service

Instrument performance can be adversely affected by installation and application problems as well as by hardware problems. We recommend that you investigate the problems in the following order:

- Installation related problems
Read the Installation section in this manual to make sure the EDC 200 has been properly installed.
- Application related problems
Review the application of the controller; then, if necessary, direct your questions to the local sales office.
- Hardware and software related problems
Use the troubleshooting error message prompts and controller failure symptoms to identify typical failures which may occur in the controller. Follow the troubleshooting procedures to correct them.

5.1 Troubleshooting Aids

An error message can occur:

- At power-up.
- When the Status Tests are requested.
- During continuous background tests while in normal operation.

Check installation

If a set of symptoms still persists, refer to Section 2 - Installation and ensure proper installation and proper use of the controller in the system.

Customer support

If you cannot solve the problem using the troubleshooting procedures listed in this section, you can get technical assistance by dialing 1-800-423-9883 USA and Canada.

An engineer will discuss your problem with you. Please have your complete model number, serial number, and Software version available. The model and serial numbers can be found on the chassis nameplate. The software version can be viewed under Setup Group Status. If it is determined that a hardware problem exists, a replacement controller or part will be shipped with instructions for returning the defective unit.

Do not return your controller without authorization from Honeywells Technical Assistance Center or until the replacement has been received.

Please refer to the Honeywell website: <http://www.honeywell.com/ps>.

Determining the firmware version

Step	Action	Press	Result
1	Select OPTION Set Up Group	SETUP	Upper Display = STA Lower Display = FMVN
2	Read the firmware version	A/M OK	Upper Display = FMVN Lower Display = VERSION

Determining the hardware version

Step	Action	Press	Result
1	Select OPTION Set Up Group	SETUP	Upper Display = STA Lower Display = HWVN
2	Read the hardware version	A/M OK	Upper Display = HWVN Lower Display = VERSION

Please give these numbers to the Customer Support person. It will indicate which version of EDC 200 you have and help them determine a solution to your problem.

5.2 Power-up Tests

When power is applied, the controller will run three diagnostic tests, including CPU, RAM, Flash and Database power on self-check. Power on self-check runs once. If the diagnostic tests failed, the controller will switch into the failsafe mode. In failsafe mode, the system will not start up properly or only display an error code. If the diagnostic tests performed successfully, the controller runs normally.

5.3 Background Tests

EDC 200 performs ongoing background tests to verify data and memory integrity. If there is a malfunction, a "Fail" will be displayed in the lower display.

Diagnose System Error

When required, the results of these tests can be checked to determine the reason the controller has gone to Failsafe.

Step	Action	Press	Result
1	Select OPTION Set Up Group	SETUP	Upper Display = 5tR Lower Display = E+Ld
2	Read the error code	A/M OK	Upper Display = E+Ld Lower Display = Error code

Check the error code parameter to view all of the error information. The following table lists the error code, probable cause and troubleshooting procedure.

Error Code	Probable Cause
ED01	Failure on restoring factory default setting
ED02	Failure on reading FCT data
ED03	Failure on reading digital sign
ED04	Failure on reading configuration data
ED05	Failure on reading verification code
ED06	verification code Comparison error
ED0A	Failure on reading product code
FC01	Parameter Configuration error
FC02	Verification data error
EC03	Input Failure



Confirm System Error

After troubleshooting the specific failure, you can proceed with the following procedure to confirm the “Fail” message.

Preliminary Steps

When the system is in the Failsafe mode, that is, when a serious malfunction occurs, there is a Fail message and current parameter values are shown on the lower display.

The controller is in Normal Operating Mode.

Step	Action	Press	Result
1	Switch the lower display to show the Fail message.		Lower Display= <i>FRi L</i>
2	Acknowledge the Failsafe message		Lower Display= “ <i>FRi L</i> ” message disappears

6. Appendix A Look-up Table for 7 Segment Character and Associated English Word

A	B	C	D	E	F	G	H	I	J	K	L	M
<i>A</i>	<i>b</i>	<i>c</i>	<i>d</i>	<i>E</i>	<i>F</i>	<i>G</i>	<i>H</i>	<i>I</i>	<i>J</i>	<i>K</i>	<i>L</i>	<i>M</i>
N	O	P	Q	R	S	T	U	V	W	X	Y	Z
<i>n</i>	<i>O</i>	<i>P</i>	<i>q</i>	<i>r</i>	<i>S</i>	<i>t</i>	<i>U</i>	<i>V</i>	<i>w</i>	<i>X</i>	<i>Y</i>	<i>Z</i>

Table 6-1 7 Segment Character and Associated English Word

7 Segment Code	Abbreviation of the Associated English Word	Full Name of the Associated English Word
<i>dl 5b</i>	DISB	DISABLE
<i>EAbL</i>	EABL	ENABLE
<i>Fl Lt</i>	FILT	FILTER
<i>AcLn</i>	ACTN	ACTION
<i>rEVR</i>	REVR	Reverse
<i>dl rL</i>	DIRT	Direct
<i>db</i>	DB	DEADBAND
<i>FlM̄d</i>	FLMD	FAILMODE
<i>FlSF</i>	FLSF	FAILSAFE
<i>PERI</i>	PERI	PERIOD
<i>rLSt</i>	RLST	RLYSTATE

Table 6-2 Examples for 7 Segment Code and Associated English Word

Sales and Service

For application assistance, current specifications, pricing, or name of the nearest Authorized Distributor, contact one of the offices below.

ASIA PACIFIC

Honeywell Process Solutions,
(TAC) hfs-tac-support@honeywell.com

Australia

Honeywell Limited
Phone: +(61) 7-3846 1255
FAX: +(61) 7-3840 6481
Toll Free 1300-36-39-36
Toll Free Fax:
1300-36-04-70

China – PRC - Shanghai

Honeywell China Inc.
Phone: (86-21) 5257-4568
Fax: (86-21) 6237-2826

Singapore

Honeywell Pte Ltd.
Phone: +(65) 6580 3278
Fax: +(65) 6445-3033

South Korea

Honeywell Korea Co Ltd
Phone: +(822) 799 6114
Fax: +(822) 792 9015

EMEA

Honeywell Process Solutions,
Phone: + 80012026455 or
+44 (0)1344 656000

Email: (Sales)

FP-Sales-Apps@Honeywell.com

or

(TAC)

hfs-tac-support@honeywell.com

AMERICAS

Honeywell Process Solutions,
Phone: (TAC) 1-800-423-9883 or
215/641-3610
(Sales) 1-800-343-0228

Email: (Sales)

FP-Sales-Apps@Honeywell.com

or

(TAC)

hfs-tac-support@honeywell.com

Specifications are subject to change without notice.

For more information

To learn more about PI New Wave
Controllers,

visit www.honeywellprocess.com

Or contact your Honeywell Account
Manager

Process Solutions

Honeywell
1250 W Sam Houston Pkwy S
Houston, TX 77042

Honeywell Control Systems Ltd
Honeywell House, Skimped Hill Lane
Bracknell, England, RG12 1EB

Shanghai City Centre, 100 Jungi Road
Shanghai, China 20061

www.honeywellprocess.com



51-52-25-155 Rev.2.0

July 2015

©2015 Honeywell International Inc.