

Thank you for purchasing the NC230 Ao/CC-Link Converter. For the correct use of this product, read through this manual before use.  
This user's manual should be kept in safety place.

## 1. CAUTIONARY NOTES FOR SAFE USE OF THE PRODUCT

The following safety symbol is indicated on the product and the manual to ensure safe use.

### CAUTION

If this symbol is indicated on the product, the operator should refer to the explanation given in the user's manual in order to avoid personnel injury or death to either themselves or other personnel, and/or damage to the instrument. The manual describes the special care that the operator should exercise to avoid or other dangers that may result in injury or loss of life.

The following symbol marks are used only in this manual.

### IMPORTANT

Indicates that operating the hardware or software in particular manner may damage it or result in system failure.

### NOTE

Draws attention to information that is essential for understanding the operations and/or features of the product.

## 2. GENERAL

The Model NC230 Ao/CC-Link Converter receives 16 points of digital signals (0 to 10000) via CC-Link unit from PLCs such as MELSEC (Mitsubishi Electric Corporation's sequencer) and so on, converts them to analog outputs signals (1 to 5 V DC) for the inputs of signal converter-(Yokogawa Electric Corporation's D Series), and couples with the signal converter via a dedicated cable.

Note: When ordering, the scaling of -30000 to 30000 for digital signals can be specified.

## 3. PREPARATION BEFORE OPERATION

Prepare following items before operation.

1. NC230 (required number)
2. NA200 (required number of cables for network signal converters; separate order for relative accessories)
3. Exclusive cables for connection between NC230 and CC-Link (required number)
4. Power line (refer to the followings)

Parts name	Specifications
Power line/grounding wire	600 V vinyl isolated wire JIS3307 0.9 to 2.0 mm <sup>2</sup>

## 4. NAMES AND FUNCTIONS OF FRONT-PANEL

### <1> Operating condition indicator LED (RDY)

light on : normal  
light off : abnormal

### <2> Operating condition indicator LED (RUN)

light on : normal communication  
light off : communication interrupted (time out)

### <3> Operating condition indicator LED (ERR)

light on : communication data error  
light off : normal communication

### <4> Operating condition indicator LED (SD)

light on : data send

### <5> Operating condition indicator LED (RD)

light on : data receive

### <6> Output connector (CN2)

Connector for analog output signals

### <7> Remote device station number setting switch

Setting of remote device station number within from 01 to 61. (01: when shipping)

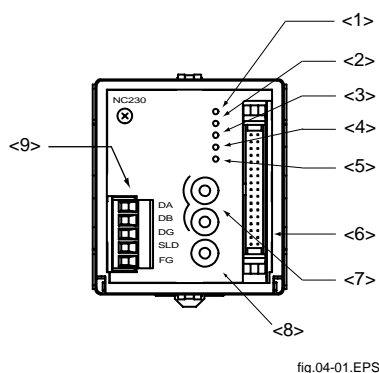

fig.04-01.EPS

### IMPORTANT

One NC230 converter occupies 4 stations. Therefore keep attention to the number that is assigned to the CC-Link unit (master unit). For detail refer to the manuals that master unit specify

## ■ Checking Product Specifications and Contents of Packing

### (1) Model Number and Suffix Code Check

Check that the model number and suffix code shown on the nameplate attached on the right side of the product are as ordered.

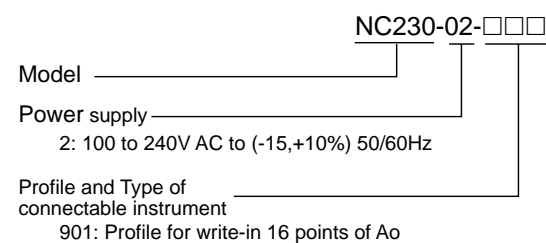
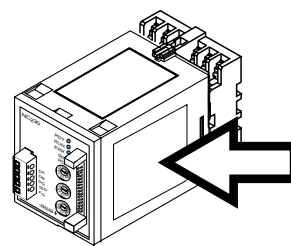

fig.04-02.EPS

### (2) Contents of the Packing Check

Check that the packing contains the following items.

- NC230 main unit : one
- User's Manual (this book: IM 77P01E01-01E) : one

### <8> Communication speed setting switch

Maximum overall communication length depends on communication speed.

Setting of switch	Communication speed	Maximum overall communication length
0	156 kbps	1200 m
1	625 kbps	600 m
2	2.5 Mbps	200 m
3	5 Mbps	150 m
4	10 Mbps	100 m

T04-01.EPS

### <9> Communication connector (CN1)

Connector for the connection of dedicated CC-Link cable

## 5. DIMENSIONS

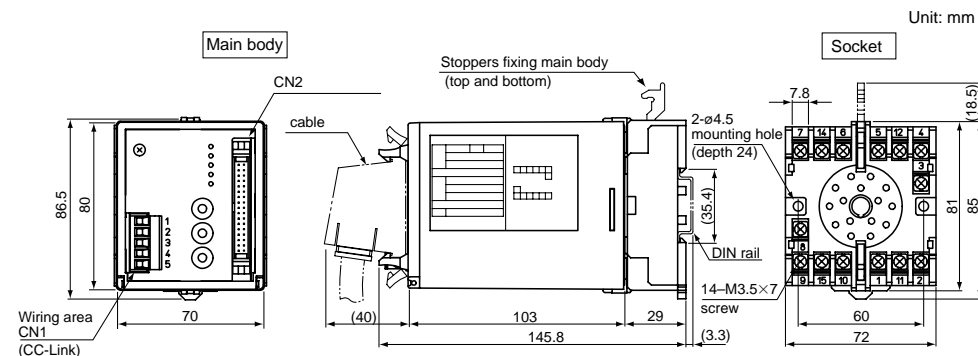

Note : CN1: Connector for CC-Link connection  
CN2: Connector for analog outputs  
fig.05-01.EPS

## 6. MOUNTING METHODS

### ● Wall mounting

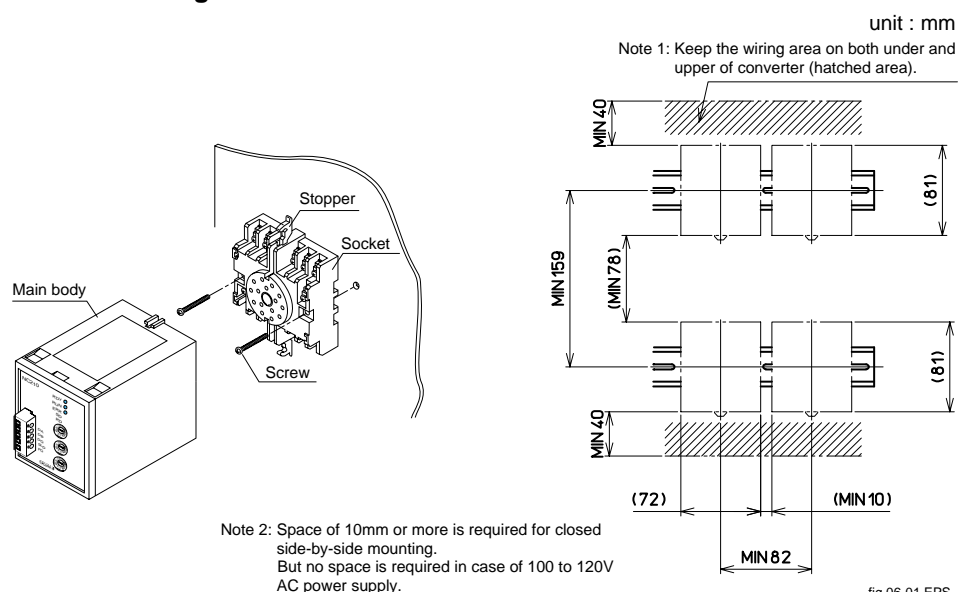

Note 2: Space of 10mm or more is required for closed side-by-side mounting.  
But no space is required in case of 100 to 120V AC power supply.

fig.06-01.EPS

Fig.6-1 Wall mounting

Fig.6-2 Mounting dimensions

Unlock the stoppers (top and bottom), and pull out the main body from the socket. Then fix the socket on wall with two M4 screws. Insert the main body to the socket and fix the body with stoppers (top and bottom).

● DIN rail mounting

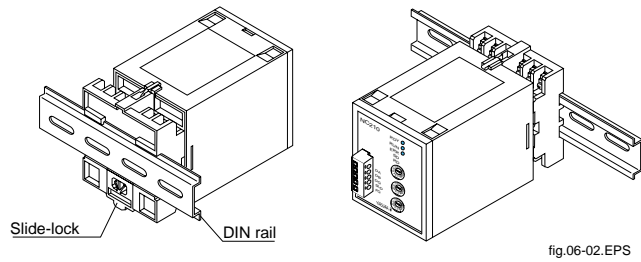

Fig.6-3 DIN rail mounting

Insert DIN rail into the upper portion of the DIN rail groove at rear of socket of the converter and fix the converter to the DIN rail with slide-lock at the lower of the converter.

7. INSTALLATION LOCATION

- (1) Avoid installation in such environments as follows.
  - The place to be exposed to the corrosive gas -such as sulfide gas - or sea breeze
  - The place where the visible dust exist
  - The place to be exposed to the direct sunlight
- (2) If there is a possibility that lightning could induce a high surge voltage on the power and signal lines, provide dedicated lightning arrestors for each sides on the lines between the field instrument and indoor instrument in order to protect the product.

8. EXTERNAL WIRING

⚠ CAUTION

Before carrying out wiring, turn off the power to the converter, and check that the cables to be connected are not alive with the tester or the like because there is a possibility of electric shock. Wiring must be carried out by persons who have basic electrical knowledge and practical experience.

Wires are connected to the terminals of the NC230 converter's socket. M3.5 screw terminals are provided for the connection of external signals. Flexible twisted wires and good contact of durable round crimp-on terminals are recommended for use.

⚠ IMPORTANT

- After wiring, check the model and specifications of the NC230 converter's body to be inserted to the socket for no-miss matching. If incorrect unit is inserted, we can't guarantee the operation.
- It may be damage for instrument if the power line is miss wiring.
- Power line and communication lines must be separated from noise occurrences. If so, we may not be guarantee.
- The other terminals excepting power line terminals should not be connected for other inter-connection terminals.

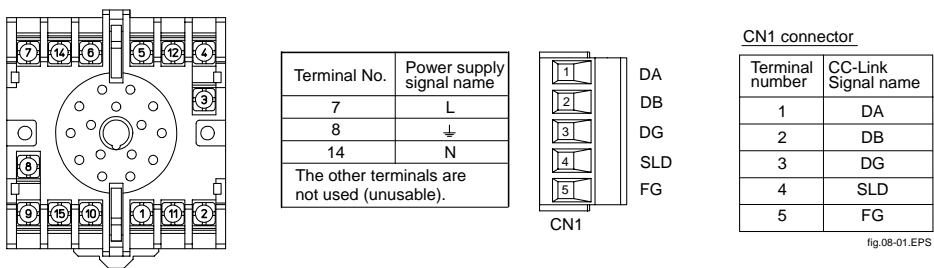
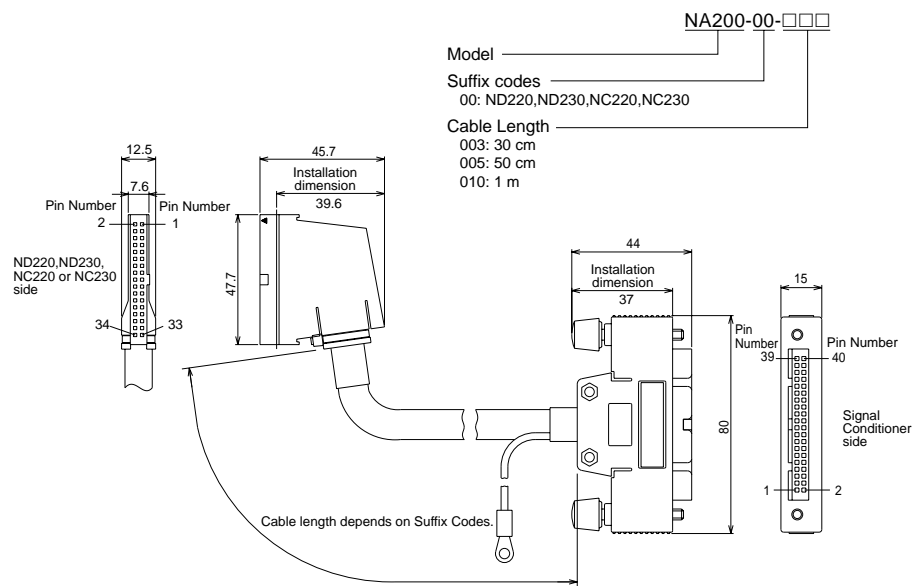

Fig.8-1 Terminal Arrangement

9. CABLE FOR NETWORK INSTRUMENT (NA200)



Adaptable Model	Connectable Signal Converter	Adaptable Nest Model
NC230	D series	DCE3□*3,DCE3□*3

fig.09-01.EPS

10. TROUBLE SHOOTING

The followings explain basic trouble shooting methods for the ND230 usage. Refer to the respective user's manuals for the SEQUENCE CPU and the master unit.

● ERR lamp light on and off

Check Items	Recovery method
Is the station number or communication speed changed while normal operation?	Recover to the normal operation station number and communication speed.

● ERR lamp light on

Check Items	Recovery method
Is the station number or communication speed changed while power off?	Recover to the normal operation station number and communication speed.

● RUN lamp light off

Refer to the item of trouble shooting in user's manual for CC-Link master unit

● RDY lamp light on and off

It is under trouble.

● RDY lamp light off

Check Items	Recovery method
Is the power on?	Check the power line and the power supply. If there are good, it is under trouble.

● In case of that the digital data cannot read out or write in.

Check Items	Recovery method
Is the RUN lamp off?	Refer to the item of trouble shooting in user's manual for CC-Link master unit
Does the ERR lamp light on and off, or light off?	Check the contents of trouble by user's manual of the sequence CPU.
Does the RUN lamp of sequence CPU light on and off, or light off?	Check the contents of trouble by user's manual of the sequence CPU.
Does the RUN lamp of master unit light off?	Refer to the item of trouble shooting in user's manual for CC-Link master unit
Do the RD or SD lamps of master unit light on?	Refer to the item of trouble shooting in user's manual for CC-Link master unit
Are there the disconnecting or snapping of wiring for analog output signal line.	Check the wrong place, by means of appearance inspection, conduction test and so on of signal wiring.
Read out output data by mean of disconnecting the analog output wire and connecting tester to output terminals.	If the check of output voltage is normal, it is effected by the noise etc for external wiring. Check the wiring and grounding.

11. PROFILE

Please write in the output data as following procedure.

[PROCEUER]

- (1) Read out Remote READY Flag (RX (n+7)B). And check that it is [1].
- (2) Write in the required data to Remote Register(RW<sub>w</sub> m+0 ~ RW<sub>w</sub> m+F)

Remote Register

	(Read out area)		(Write in area)	
	Remote → Master	Contents	Master → Remote	Contents
← No.1 output	RW <sub>w</sub> n+0		RW <sub>w</sub> m+0	No.1 Output setting data
← No.2 output	RW <sub>w</sub> n+1		RW <sub>w</sub> m+1	No.2 Output setting data
← No.3 output	RW <sub>w</sub> n+2		RW <sub>w</sub> m+2	No.3 Output setting data
← No.4 output	RW <sub>w</sub> n+3		RW <sub>w</sub> m+3	No.4 Output setting data
← No.5 output	RW <sub>w</sub> n+4		RW <sub>w</sub> m+4	No.5 Output setting data
← No.6 output	RW <sub>w</sub> n+5		RW <sub>w</sub> m+5	No.6 Output setting data
← No.7 output	RW <sub>w</sub> n+6		RW <sub>w</sub> m+6	No.7 Output setting data
← No.8 output	RW <sub>w</sub> n+7		RW <sub>w</sub> m+7	No.8 Output setting data
← No.9 output	RW <sub>w</sub> n+8		RW <sub>w</sub> m+8	No.9 Output setting data
← No.10 output	RW <sub>w</sub> n+9		RW <sub>w</sub> m+9	No.10 Output setting data
← No.11 output	RW <sub>w</sub> n+A		RW <sub>w</sub> m+A	No.11 Output setting data
← No.12 output	RW <sub>w</sub> n+B		RW <sub>w</sub> m+B	No.12 Output setting data
← No.13 output	RW <sub>w</sub> n+C		RW <sub>w</sub> m+C	No.13 Output setting data
← No.14 output	RW <sub>w</sub> n+D		RW <sub>w</sub> m+D	No.14 Output setting data
← No.15 output	RW <sub>w</sub> n+E		RW <sub>w</sub> m+E	No.15 Output setting data
← No.16 output	RW <sub>w</sub> n+F		RW <sub>w</sub> m+F	No.16 Output setting data

T11-01.EPS

● Output setting data — Write in area —

The output setting data are converted to analog output signals, and the analog output signals are coupled with signal converter — D series — via a dedicated cable . (Output setting range : -32767 to +32767) The scale range of the Output setting data to be converted to analog output signals is 0 to 10000 in default when ordering, for shipping.

[For example] When the scale range is 0 to 10000, and a analog output value is required 3V, write in [5000] in Remote Register (RW<sub>w</sub> m+0~RW<sub>w</sub> m+F).

12. MAINTENANCE

The NC230 main body can be removed from the socket under operating in case of exchange or maintenance of the converter. However before removing the main body of the converter, remove the CC-Link communication cable.

⚠ CAUTION

After remove CC-Link connector from the main body, carry out the maintenance of the converter. There is a possibility of electric shock, so be careful not to touch the terminals of the socket when the NC230 main body is removed from the socket under operating condition.