

LOW VOLTAGE AC DRIVES

ABB drives for water and wastewater

ACQ580, 0.75 to 500 kW



ACQ580 series

Always flowing. Never still.

Water utilities require reliable solutions securing the flow of water and wastewater.

The ACQ580 drive for water is part of ABB's all-compatible drives portfolio. This robust drive is designed to secure optimal operation of water and wastewater pumps, while ensuring low energy consumption.

Table of contents

04–11	The energy efficient drive for water and wastewater pumping
06–07	All-compatible solutions for water and wastewater applications
08–09	Optimizing the flow of water and wastewater in your pumping solutions
10	Built-in pump application software
11	General software features of the drive
12–19	How to select a drive
13	Technical specification
14	Securing the flow of water and wastewater with the ACQ580
15	Complete offering from wall-mounted drives to cabinet installations
16–17	Overcome challenges of harmonics
18–23	Ratings, types and voltages
24	Dimensions
25–41	Options
25	Comprehensive connectivity
26	Hand-Off-Auto control panel
27	Effortless drive commissioning and use with control panels
28	ABB Ability™ smartphone apps
29	High protection for operation in harsh environments
29	Flange mounting
29	Advanced cooling
30	Quick configuration for unpowered drives
31	Flexible connectivity to automation
32	Thermistor protection modules for increased safety
33	Main disconnect switch for increased safety
34	EMC – electromagnetic compatibility
36	du/dt filters
37–38	du/dt filter selection
39–41	Cooling and fuses
42–45	Motors control and automation products
42	Choose the motor for your water application
43	Ultimate efficiency and reliability to minimize your system cost of ownership
44	ABB automation products
45	Securing the flow of water and wastewater in the pump system
46–47	Services to match your needs
48	A lifetime of peak performance
49	ABB Ability™ Condition Monitoring for drives

The energy efficient drive for water and wastewater pumping

Whether your pump system requires redundancy in multi-pump applications or built-in pump application functionalities designed for the water and wastewater industry, the ACQ580 is designed to meet your requirements.



Simplicity at your fingertips

The control panel's straightforward primary settings menu with assistants helps you set up the drive quickly and effectively. See more on pages 26-27.

Speaks water-specific terminology

The drive has built-in pump application control programs to secure optimal operation of the water and wastewater pumps. See more on page 11.

Boosting energy efficiency

The energy optimizer helps you to save energy, and the energy efficiency information made available to you help monitor and save the energy used in your processes. The drive meets IE2 energy efficiency requirements. See more on page 11.



Reliable, integrated safety

Safe torque off (STO) built-in as standard and the ATEX certified thermistor protection module, EX II (2) GD, CPTC-02 provides enhanced process safety and easy, simplified installation. See more on page 32-33.



Remote monitoring solutions

Remote monitoring via standard web browsers will help lower costs by reducing the amount of routine site visits. See more on page 30.

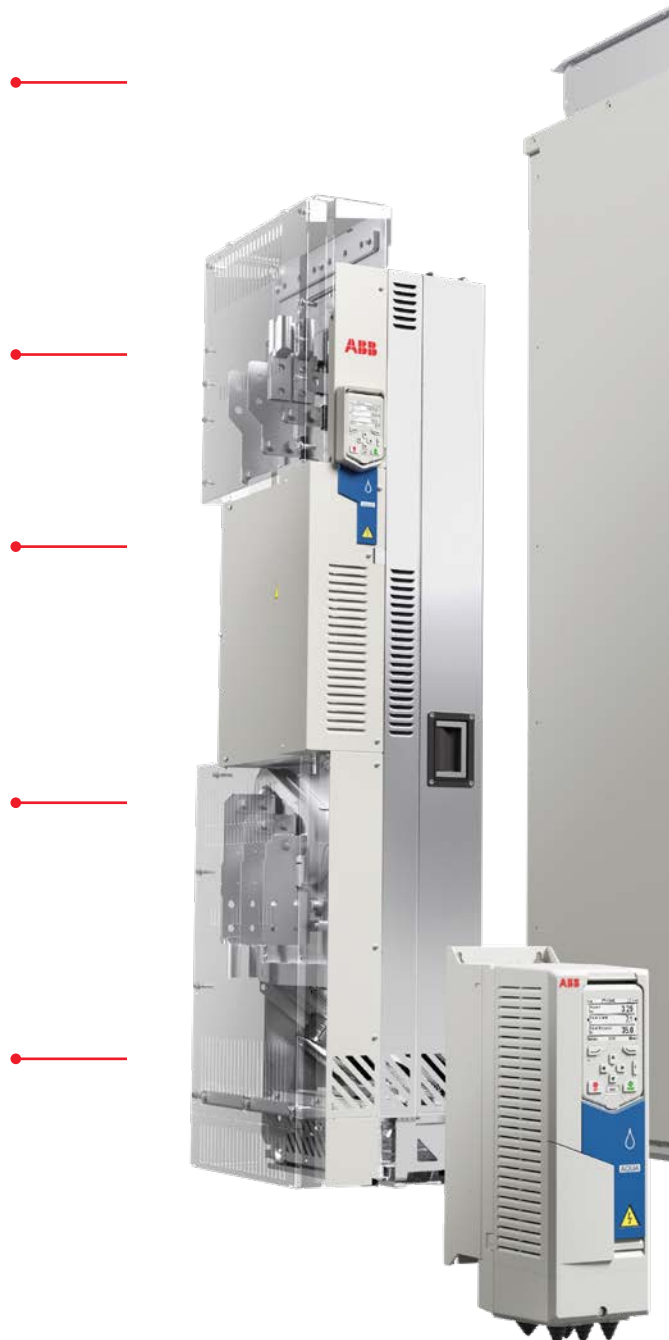

The ACQ580 water and wastewater drives are part of ABB's all-compatible drives portfolio. The drives secure the flow of water and wastewater in the pumping system throughout their whole life cycle. The ACQ580 drive is easy to commission and use. With built-in pump functionalities, the drive keeps the pumping system operating optimally, lowering the energy bill. The drive is used in water and wastewater treatment plants, pumping stations, desalination plants, industrial wastewater facilities and irrigation environments. The drive is used with inflow pumps, transfer pumps, dosing pumps, sludge pumps, booster pumps, submersible pumps and compressors, blowers, decanter centrifuges, mixers and fans.



Controls virtually any kind of motor

The drive has the ability to control almost any motors from induction and permanent magnet motors to synchronous reluctance motors. See more on pages 42-45.



Startup and maintenance tool

Drive composer PC tool for startup, configuration, monitoring and process tuning. The PC tool is connected to the drive's control panel with a standard USB cable. See more on page 30.

Robust with built-in features

A robust performer with enclosure class up to IP55, that is simple to select, and easy to install and use. Built-in features such as an EMC filter, choke, a Modbus RTU fieldbus interface and safe torque off (STO) functionality simplify drive selection, installation and use. See more on pages 29, 37.



Reliable communication

With its wide range of optional fieldbus adapters and embedded RTU Modbus, the drive enables connectivity with all major automation networks and control systems. See more on page 31.



Input/output extensions

In addition to the standard interfaces, the drive has a built-in slot for additional input/output extension modules. See more on page 31.

Ultra-low harmonic (ULH) solution for a clean network

The ACQ580 ultra-low harmonic drive is designed to minimize the effect of harmonics distortion on your electrical system. The drive keeps the network in the waterutility clean and stable. As a result electrical equipments in the plant wastes less energy in heat and less unwelcome disturbance occur. See more on pages 16-17.

All-compatible solutions for water and wastewater applications

Environment all-compatible

Achieve your environmental goals with our energy-efficient drive for water and wastewater. The all-compatible drives offer built-in energy efficiency calculators. They help you to analyze and optimize your pump processes to reduce stress on the environment. Other environmentally friendly features include the built-in soft pipe fill function to ensure less water hammering on the water pipes, thus preventing the risk of unwanted leaks, unplanned outage and repair costs.

Process all-compatible

Water and wastewater processes consist of many phases which require optimal performance of your pump solution from start to finish. Our robust drives are available with enclosures up to IP55. The drive controls virtually any kind of motors from induction and permanent magnet motors to synchronous reluctance motors up to 500 kW. The drive is compatible with a wide range of fieldbus protocols, ensuring reliable communication between the drive and automation system in use.



Business all-compatible

As a reliable global partner, we provide water process solutions that help to keep the life cycle costs of your pump solution stable. Additionally, we help keep your water process productive and consistent in an energy efficient way. Our wide range of water industry products and solutions offer optimal flow of water all hours of the day. This means lower energy consumption, improved productivity, flexibility and ease of use. With offices in over 90 countries and a global technical partner network, we offer technical advice and local support worldwide.

Human all-compatible

You can feel confident using our all-compatible drives for water and wastewater. The drive speaks the language of your pump application, making it easy to set up, configure and use. The intuitive Hand-Off-Auto control panel ensures that you have access to the essential information quickly. For accessing your drive from a distance and receiving valuable analytics, we offer remote monitoring solutions.

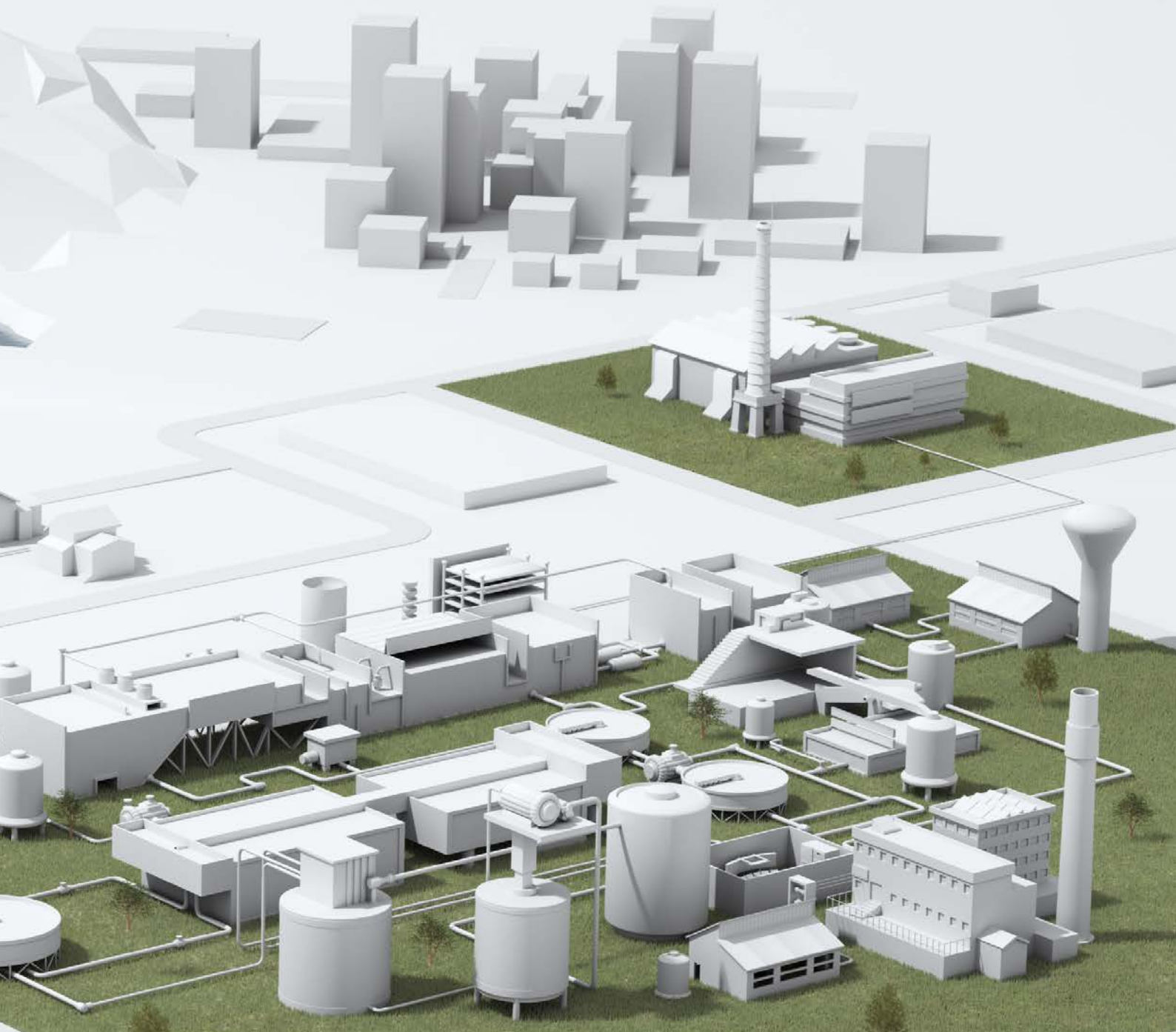

Optimizing the flow of water and wastewater in your pumping solutions

The ACQ580 water and wastewater drive is built to help users, designers, OEMs, system integrators and EPC professionals secure pumping of water and wastewater in municipal utilities, pumping stations, industrial wastewater facilities, desalination plants and irrigation environments. It offers long-term, technically-compatible drive solutions supported by full service and support.

Soft pipe filling

Increase the lifetime of the piping and pump system by avoiding pressure peaks.

Quick ramps

Extend the lifecycle of a submersible pumps by reducing wear of the mechanical parts using ramp sets to accelerate and decelerate the pumps.

Pump priority

Achieve energy savings with optimal pump alternation by running the higher capacity pumps when the consumption rate is higher.

Multi-pump control

Ensure stable and uninterrupted production with multi-pump controls by optimizing the speed and number of running pumps.

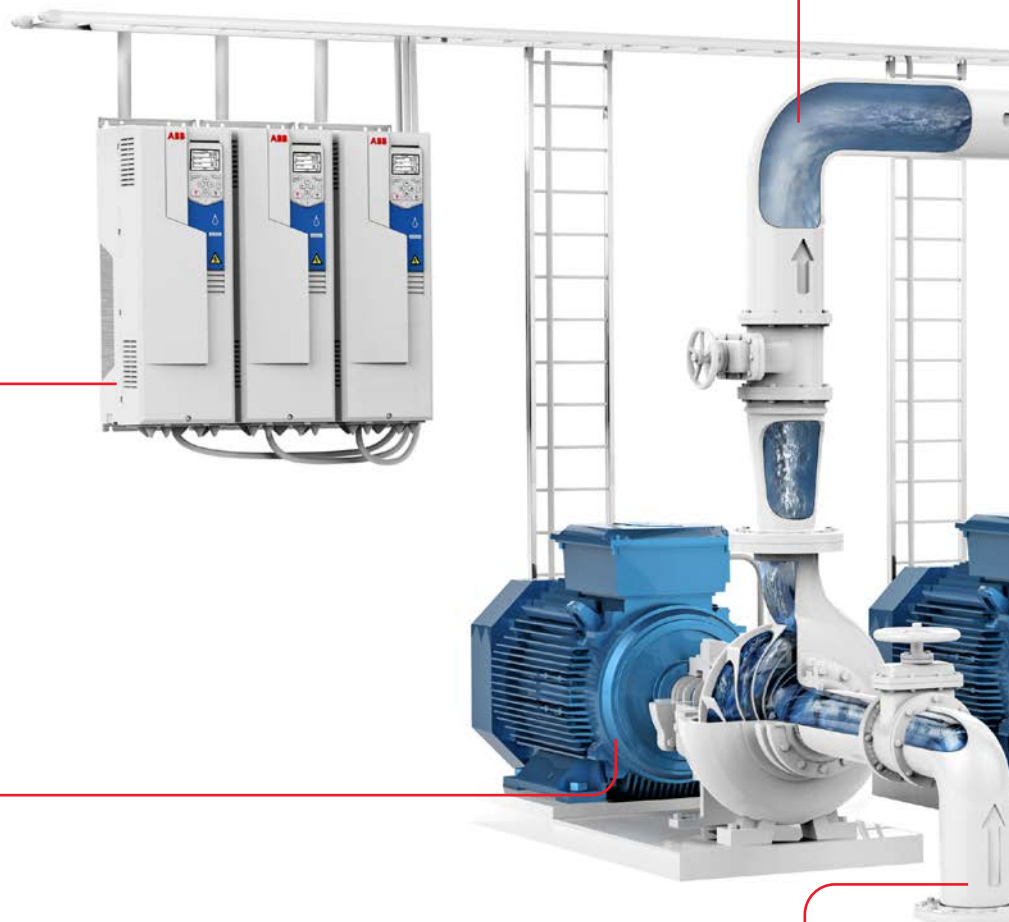

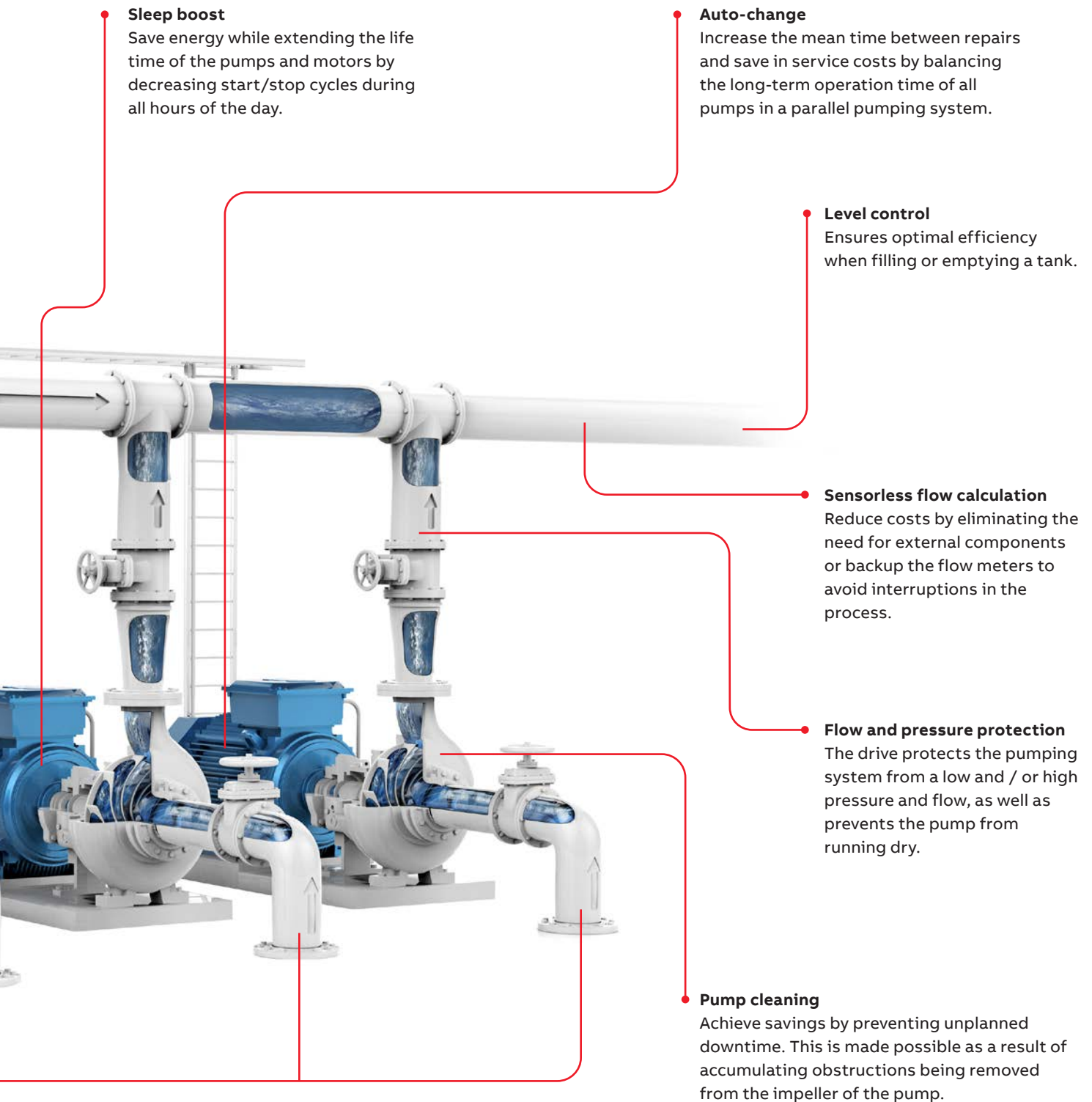

Built-in pump application software

The built-in pump application software in the ACQ580 drives is designed to enhance the reliability and durability of the water and wastewater application in which it is used. The functions protect the pump and secure its optimal functionality, increasing cost efficiency. The built-in functionalities also support the user in securing the flow of the water and wastewater in the pump solution.



Multi-pump functionality

The function maintains stable process conditions for several parallel pumps (up to 8 pumps at the same time) operating together. It is possible to optimize the speed and number of pumps needed when the required flow or pressure rate is variable. This built-in functionality ensures continuous operation for multipump systems even if one or more pumps fails or requires maintenance.



Sensorless flow calculation

Measures the amount of water flowing without the need for external sensors. This will enable you to reduce costs as there is no need for setting up and using additional sensors or back up the flow meters to avoid interruptions in the process.



Level control

Control the filling or emptying of wastewater storage and water tower tanks. Level control can be used within a station controlling up to eight pumps. The level control function has varying pre-set water levels and the pumps will start and stop based on measured level. This method allows the pumps to run at an efficient speed and ensures the pump sump does not become over contaminated by sediment.



Soft pipe fill

The soft pipe fill function manages the pressure of water by filling the pipeline with a gentle approach. This helps to avoid sudden pressure peaks and reduces the risk of water hammer which can cause damage to the water pipes.



Quick-ramp

Protect bearings when a submersible pump is started without water. Quick ramp allows your pump to reach optimal speed to extend pump life, ensure operation and prevent unplanned outages.



Pump cleaning

Keeps the impeller of the pump clean by running a sequence of aggressive ramps between minimum and maximum pump speed.



Turbidity reduction

When a pump starts as slow as possible, it creates the lowest turbidity values for the water being moved or extracted. When you combine quick ramps and long normal ramps, the drive will protect and run submersible pump most optimal way.



Pump protection

The built-in protection functionalities ensures that pumps can operate at the best possible conditions. The maximum pressure protections help to protect the pump and the system in case of a blockage in the pipeline. In case of a pipe rupture, the minimum pressure protection can generate an alarm or fault or can be programmed to run at certain speed to avoid dirty water entering the pipeline. The inlet pressure protection can help to avoid cavitation. When the inlet pressure of a water pump falls below pump design specifications, tiny vapor bubbles form. These bubbles collapse when they meet the impeller, causing shock waves and points of high temperature that can corrode the surface of the impeller.



Dry run protection

This function prevents the pump from running dry. The water pump shaft and impeller are rotating at fast rates. If there is no dry pump protection, the released heat can damage the pump over time, limiting its lifetime.

General software features of the drive

With a pump control software one drive controls several pumps or blowers in parallel and eliminates the need for an external programmable logic controller. This results in reduced stress on the mains and the system as well as in lower maintenance and operation costs.

Startup assistant allows first-time users to quickly customize the drive, out of the box, according to their needs. This is complemented by a built-in help function to make parameter-by-parameter setting easy.

Enjoy sophisticated process control in scalar and vector control modes. They support a wide range of motors including induction, permanent magnet and synchronous reluctance motors.

The energy optimizer feature operates both in scalar and vector control modes, ensuring maximum torque per ampere and reducing energy drawn from the supply. You can follow the saved energy, CO₂ emissions or money, and see how fast the drive brings you a return on investment.

The drive reduces motor noise by spreading the switching frequencies over a user-specified range. The higher used switching frequency reduces motor noise at low load without limiting full current at maximum load.

Diagnostic assistant helps in locating the cause of any disturbance to the drive, and even suggests possible remedies. This reduces process downtime by making repairs or adjustments effortless.

A built-in and stand-alone process PID/loop controller makes the drive a self-governing unit that requires no external logic input from the control room but requires only an external process measurement.

Load profile feature collects drive values, such as current and stores them in a log. This enables you to analyze and optimize the application with the help of historical data load.

Adaptive programming provides extra flexibility by offering easy alternative for simple programming needs.

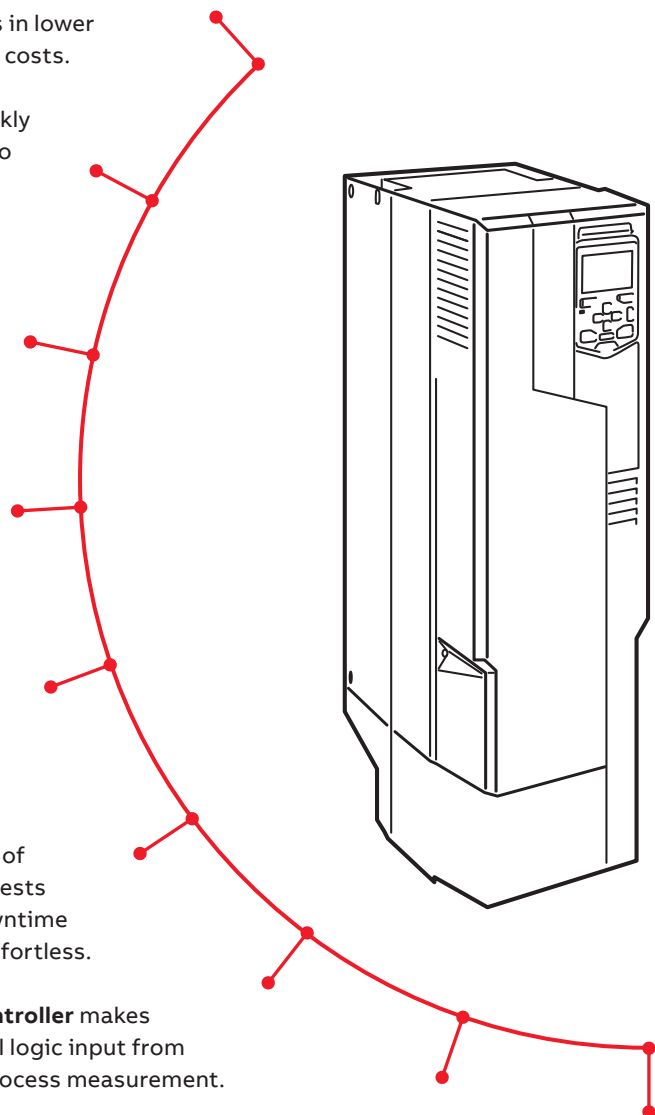

How to select a drive?

It is very easy to select the right drive. This is how you build up your own ordering code using the type designation key.

1 Start with identifying your supply voltage.

This tells you what rating table to use.
The ACQ580 supports 200 to 480 V.

2 Choose your motor's nominal power rating

from the ratings table on pages 18-23.

3 Select your drive's type code

from the rating table based on your motor's nominal power rating.

4 Choose your options.

Details about each option begin on page 26. Add the option codes to the end of the drive's ordering code. Remember to use a "+" before each option code.

- Control panels 26-27
- Protection classes 29
- Flange mounting..... 29
- Quick configuration 30
- Remote monitoring 30
- Fieldbus adapters..... 31
- I/O extension and thermistor protection modules 32-33
- EMC 34
- du/dt..... 36-38

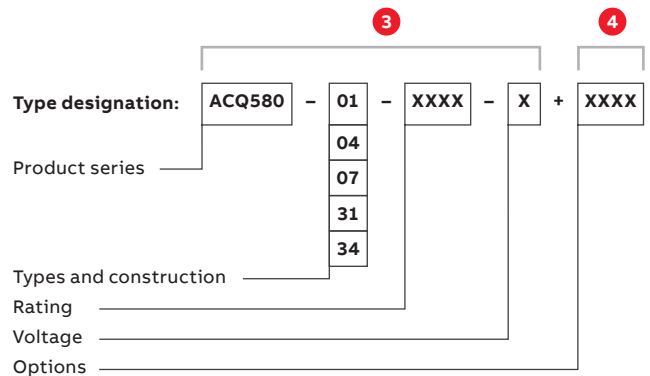

Example configuration:

ACQ580-01-145A-4+B056+J400+L501

Wall-mounted 145 A, 400 V drive in IP55 enclosure with Hand-Off-Auto control panel and internal CMOD-01 input/output option

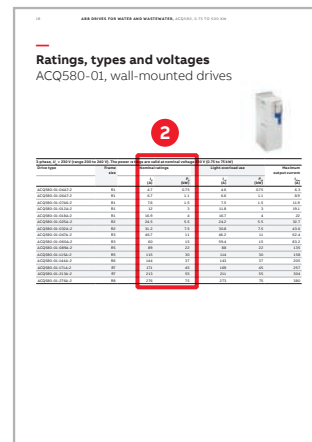

Pages 18-23

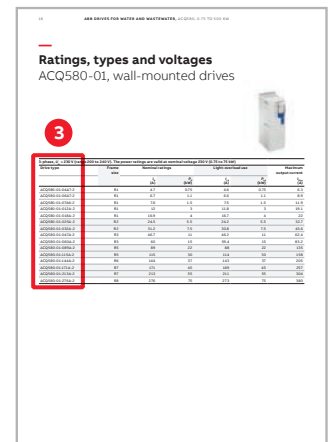

Pages 18-23

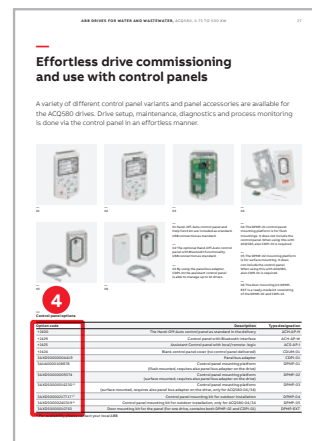

Pages 27-41

Technical specification

Mains connection											
Voltage range	3-phase, U_N										
Power range	<table border="1"> <tr> <td>ACQ580-01 wall-mounted</td> <td>0.75 to 250 kW (frame sizes R1 to R9)</td> </tr> <tr> <td>ACQ580-04 module</td> <td>250 to 500 kW (frame sizes R10 to R11)</td> </tr> <tr> <td>ACQ580-07 cabinet</td> <td>75 to 500 kW (frame sizes R6 to R11)</td> </tr> <tr> <td>ACQ580-31 ULH wall-mounted</td> <td>4 to 110 kW (frame sizes R3, R6 and R8)</td> </tr> <tr> <td>ACQ580-34 ULH module</td> <td>132 to 355 kW (frame size R11)</td> </tr> </table>	ACQ580-01 wall-mounted	0.75 to 250 kW (frame sizes R1 to R9)	ACQ580-04 module	250 to 500 kW (frame sizes R10 to R11)	ACQ580-07 cabinet	75 to 500 kW (frame sizes R6 to R11)	ACQ580-31 ULH wall-mounted	4 to 110 kW (frame sizes R3, R6 and R8)	ACQ580-34 ULH module	132 to 355 kW (frame size R11)
ACQ580-01 wall-mounted	0.75 to 250 kW (frame sizes R1 to R9)										
ACQ580-04 module	250 to 500 kW (frame sizes R10 to R11)										
ACQ580-07 cabinet	75 to 500 kW (frame sizes R6 to R11)										
ACQ580-31 ULH wall-mounted	4 to 110 kW (frame sizes R3, R6 and R8)										
ACQ580-34 ULH module	132 to 355 kW (frame size R11)										
Frequency	50/60 Hz $\pm 5\%$										
Power factor (-01, -04, -07) (-31, -34)	$\cos\varphi = 0.98$ $\cos\varphi = 1$										
Efficiency (at nominal power)	98%										
Motor connection											
Voltage	0 to U_N , 3-phase										
Frequency	0 to 500 Hz										
Motor control	Scalar and vector control										
Speed control	Static accuracy: 20% of motor nominal slip Dynamic accuracy: 1% seconds with 100% torque step										
Product compliance											
CE											
Low Voltage Directive 2014/35/EU, EN 61800-5-1:2007											
Machinery Directive 2006/42/EC, EN 61800-5-2:2007											
EMC Directive 2014/30/EU, EN 61800-3:2004 + A1:2012											
RoHS directive 2011/65/EU											
Waste electrical and electronic equipment directive (WEEE) 2000/96/EC											
Quality assurance system ISO 9001 and Environmental system											
RCM, EAC, UI, cUL											
TÜV Nord (safety functions)											
EMC according to EN 61800-3:2004 + A1:2017											
ACQ580-01/-31	Class C2 as standard										
ACQ580-04/-34	Class C3 as standard										
ACQ580-07	Class C2 as standard for powers 75 kW to 250 kW and Class C3 as standard for powers 250 kW to 500 kW										
Harmonic mitigation											
Built-in swinging choke as standard in ACQ580-01 meets the requirements of IEC 61000-3-12: 2011.											
ACQ580-31 and ACQ580-34 in addition meets the requirements of IEE519 and G5/4.											

Environmental limits		
Ambient temperature		
Transport	-40 to +70 °C	
Storage	-40 to +70 °C	
Operation area	ACQ580-01/-31	-15 °C to 50 °C. No frost allowed. From +40 °C to +50 °C with derating 1% per 1 °C.
	ACQ580-04/-34	-15 °C to 55 °C. No frost allowed. From +40 °C to +55 °C with derating 1% per 1 °C.
	ACQ580-07	0 °C to +50 °C. No frost allowed. From +40 °C to +50 °C with derating 1% per 1 °C.
Cooling method		
Air-cooled	Dry clean air	
Altitude		
0 to 1.000 m	Without derating	
1.000 to 4.000 m	With derating of 1%/100 m	
Relative humidity	5 to 95%. no condensation allowed	
Degree of protection	ACQ580-01/-31	IP21 (UL Type 1) and IP55 (UL Type 12)
	ACQ580-04/-34	IP00 as standard and IP20 as option
	ACQ580-07	IP21 as standard, IP42 and IP54 as option
Functional safety	Safe torque off (STO according EN 61800-5-2) IEC 61508 ed2: SIL 3, IEC 61511: SIL 3, IEC 62061: SIL CL 3, EN ISO 13849-1: PL e	
Contamination levels	No conductive dust allowed	
Storage	IEC 60721-3-1. Class 1C2 (chemical gases). Class 1S2 (solid particles)*)	
Operation	IEC 60721-3-3. Class 3C2 as standard and 3C3 as option (chemical gases). Class 3S2 (solid particles)*)	
Transportation	IEC 60721-3-2. Class 2C2 (chemical gases). Class 2S2 (solid particles)*)	

*) C = chemically active substances
S = mechanically active substances

Securing the flow of water and wastewater with the ACQ580

The ACQ580 is a robust and compact drive ensuring low energy consumption and continuous, reliable motor control with a power and voltage range from 0.75 to 500 kW and 200 to 480 V. It has coated boards and offers enclosure classes up to IP55 for different environments. The drive is designed for water and wastewater pumps, blowers, mixers, centrifuges and fans.

—
01 The ACQ580 drive series

—
02 Flange mounting for panel installation ensures less thermal load inside the panel by keeping most of the losses outside the panel.

Built-in pump functionality for optimal flow of water

Built-on ABB's common drives architecture, the drive offers pump operation, energy savings and usability benefits supported by a local network of service and support. The water and wastewater drive has several different built-in pump application features for optimal pump operation (see page 10).

Intuitive usability supported by simple connectivity

To ensure fast set-up and operation of the drive, adjusting drive settings has been made easy with the robust and intuitive Hand-Off-Auto control panel. The control panel has a powerful diagnostics menu that makes it possible to quickly access information, even in facilities with poor visibility. Drive usability is further enhanced via wireless Bluetooth connectivity between the drive and mobile devices, making it easy to access the drive in difficult-to-reach locations. Connectivity to automation systems is ensured with the drive connecting to various fieldbus protocols. To ensure compliance with electric grids, the ACQ580 has a built-in 1st environment EMC filter and choke. The drive also supports functional safety design, as it offers integrated safety features with safe torque off (STO) built-in as standard.

The wall-mounted drive (ACQ580-01, -31) offers flange mounting as an option, separating the control electronics from the main circuit cooling airflow, saving space and ensuring optimal cooling and extends the lifetime of the drive. The cabinet-built drive (ACQ580-07) offers flange mounting as a standard solution. This results in better thermal management in panel installation. The advanced pedestal system and ramp of the drive module (ACQ580-04, -34) ensure easy installation and reduce time needed for setup and commissioning.



—
01



—
02

Complete offering from wall-mounted drives to cabinet installations

No matter the frame size or power range, all ACQ580 drives bring you ease of use, scalability and quality.

—
01 Wall-mounted IP21 drive (ACQ580-01)

The wall-mounted IP21 drives

The wall-mounted IP21 drives are available with the power and voltage range from 0.75 to 250 kW and 3-ph 200 to 480 V. Side-by-side mounting, flange mounting and horizontal mounting are all available for the wall-mounted ACQ580 drives.

—
02 Wall-mounted IP55 drive (ACQ580-01+B056)

The wall-mounted IP55 drives

The IP55 drive is designed for applications exposed to dust, moisture, vibrations and other harsh environments. It is similar in size to the compact IP21 drives, which provides significant savings in space, maintenance, engineering, material costs, as well as in setup and commissioning time.

—
03 Drive module IP00 (ACQ580-04)

Drive modules for cabinet installations

The ACQ580 drive modules are optimal for system integrators, cabinet builders or OEMs who want to optimize the cabined design in the 250 to 500 kW range, but do not want to compromise the easy installation, commissioning and maintenance.

—
04 Cabinet-built IP42 drive (ACQ580-07+B054)

Cabinet-built drives

The cabinet-built drives are type tested ABB solutions offering robust but easy to use cabinets with a new and innovative cooling arrangement. The ABB made cabinets have many in-built features as standard, delivered with short lead times and always made according to ABB's high quality standards. The design is available as standard for all available protection classes IP21 / 42 / 54 in frames R6 to R11. The power and voltage range is from 75 kW to 500 kW, 3-ph 380 to 480 V.

To select IP classes for the drive see page 24.



Overcome challenges of harmonics

ACQ580 ultra-low harmonic drives have excellent harmonics performance and are perfectly suited for places that cannot handle high harmonic content in the network.

The problem with harmonics

Generators in power plants rotate at constant and regulated speed, resulting in a sine-wave shaped current in an AC grid in the ideal case.

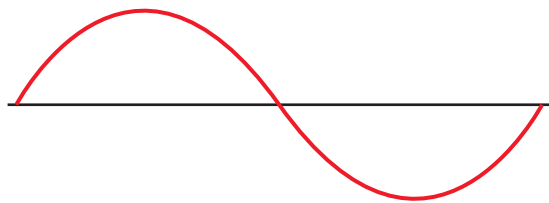

However, in the modern world, the network is not pure sine wave. Electricity networks are affected by harmonics: higher-order oscillations introduced by various types of electrical equipment.

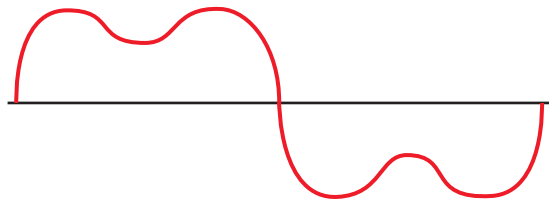

Harmonics may cause premature failure or reduced lifespan of other electrical equipment caused by the overheating of network components like transformers and cables. Harmonics in the network are also responsible for disturbing other electrical equipment in the network that require a pure sinusoidal AC-waveform. Harmonics may also cause unstable operation in back-up generators.

All-in-one concept for a clean network

ABB's ultra-low harmonic (ULH) drives for water are designed with built-in harmonic avoidance systems and complies with IEC61000-3-12. Also extremely low harmonic content helps your system to meet IEEE519 and G5/4 harmonic recommendations. Compared to other harmonic mitigation solutions, the problems caused by harmonics are avoided in the first place. ULH drives have excellent harmonic performance technology built-in, including active supply unit and integrated low harmonic line filter. There is no need for external harmonic filters or multi-pulse transformers, leading to significant savings in the footprint.

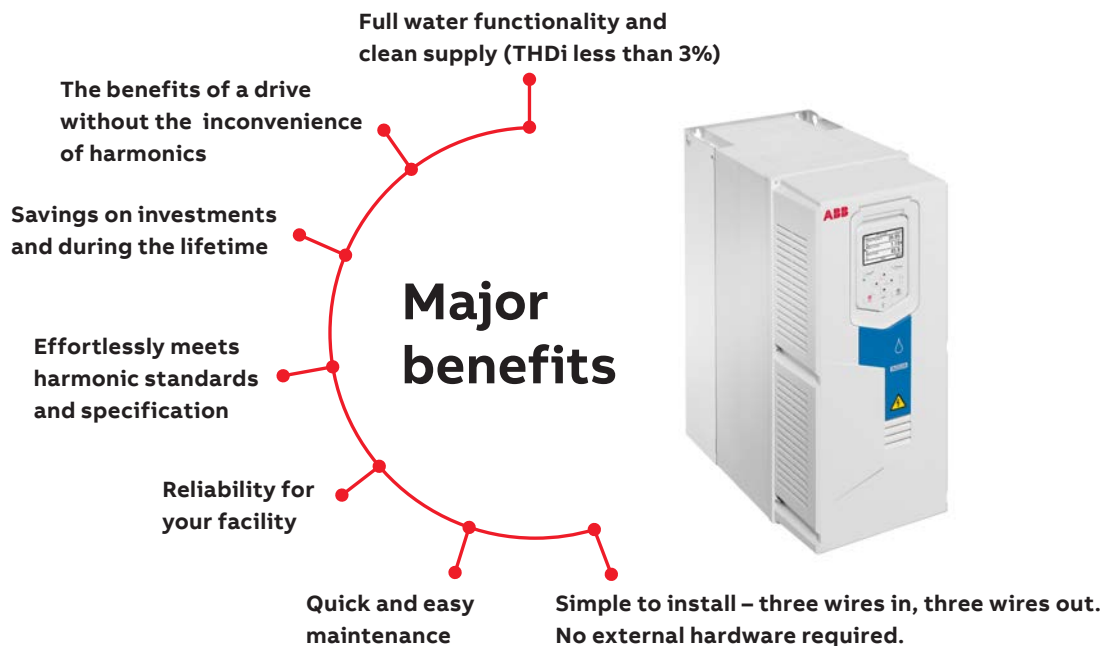

Reliable operation under special conditions

ULH drives ensure that the motor receives the full voltage, even in low-voltage utility condition or in a fluctuating network. Thanks to the drives' capability to provide an output voltage up to 15 percent greater than the supply voltage, applications can overcome voltage drops caused by long supply or motor cables. All this is done without costly additional equipment or oversizing of drive system components.

Savings in total cost of ownership

Electrical utilities may charge additional penalties for consuming reactive power. The ULH drives has unity true power factor as a result of its low harmonics and no consumption of reactive power. Additionally, the drive is able to compensate the displacement power factor of the network, to which it is connected. This reduces the risk of having additional running costs or buying additional capacitor banks to correct the power

factor. With an integrated design that leverages drive technology as part of the harmonic solution, there is no risk of nuisance trips due to incompatible components, no need for additional hardware and no additional cooling requirements.

Compared to other harmonic mitigation solutions, like passive and active filters, system level efficiency is better when there are less components in the network. Also there is savings in the installation and maintenance costs.

In retrofit projects, the transformer might not be dimensioned to meet the harmonic levels caused by non-linear loads such as standard 6-pulse drives, so there is a risk of overloading the transformer. Thanks to the extremely low harmonic content of ULH drives there is no need to overdimension the transformer, switchgear, or cables.



Ratings, types and voltages

ACQ580-01, wall-mounted drives



3-phase, $U_N = 230$ V (range 200 to 240 V). The power ratings are valid at nominal voltage 230 V (0.75 to 75 kW)

Drive type	Frame size	Nominal ratings		Light-overload use		Maximum output current
		I_N (A)	P_N (kW)	I_{Ld} (A)	P_{Ld} (kW)	I_{Max} (A)
ACQ580-01-04A7-2	R1	4.7	0.75	4.6	0.75	6.3
ACQ580-01-06A7-2	R1	6.7	1.1	6.6	1.1	8.9
ACQ580-01-07A6-2	R1	7.6	1.5	7.5	1.5	11.9
ACQ580-01-012A-2	R1	12	3	11.8	3	19.1
ACQ580-01-018A-2	R1	16.9	4	16.7	4	22
ACQ580-01-025A-2	R2	24.5	5.5	24.2	5.5	32.7
ACQ580-01-032A-2	R2	31.2	7.5	30.8	7.5	43.6
ACQ580-01-047A-2	R3	46.7	11	46.2	11	62.4
ACQ580-01-060A-2	R3	60	15	59.4	15	83.2
ACQ580-01-089A-2	R5	89	22	88	22	135
ACQ580-01-115A-2	R5	115	30	114	30	158
ACQ580-01-144A-2	R6	144	37	143	37	205
ACQ580-01-171A-2	R7	171	45	169	45	257
ACQ580-01-213A-2	R7	213	55	211	55	304
ACQ580-01-276A-2	R8	276	75	273	75	380

3-phase, $U_N = 400$ V (range 380 to 480 V). The power ratings are valid at nominal voltage 400 V (0.75 to 250 kW)						
Drive type	Frame size	Nominal ratings		Light-overload use		Maximum output current
		I_N (A)	P_N (kW)	I_{Ld} (A)	P_{Ld} (kW)	I_{Max} (A)
ACQ580-01-02A7-4	R1	2.6	0.75	2.5	0.75	3.2
ACQ580-01-03A4-4	R1	3.3	1.1	3.1	1.1	4.7
ACQ580-01-04A1-4	R1	4	1.5	3.8	1.5	5.9
ACQ580-01-05A7-4	R1	5.6	2.2	5.3	2.2	7.2
ACQ580-01-07A3-4	R1	7.2	3	6.8	3	10.1
ACQ580-01-09A5-4	R1	9.4	4	8.9	4	13
ACQ580-01-12A7-4	R1	12.6	5.5	12	5.5	14.1
ACQ580-01-018A-4	R2	17	7.5	16.2	7.5	22.7
ACQ580-01-026A-4	R2	25	11	23.8	11	30.6
ACQ580-01-033A-4	R3	32	15	30.4	15	44.3
ACQ580-01-039A-4	R3	38	18.5	36.1	18.5	56.9
ACQ580-01-046A-4	R3	45	22	42.8	22	67.9
ACQ580-01-062A-4	R4	62	30	58	30	76
ACQ580-01-073A-4	R4	73	37	68.4	37	104
ACQ580-01-088A-4	R5	88	45	83	45	122
ACQ580-01-106A-4	R5	106	55	100	55	148
ACQ580-01-145A-4	R6	145	75	138	75	178
ACQ580-01-169A-4	R7	169	90	161	90	247
ACQ580-01-206A-4	R7	206	110	196	110	287
ACQ580-01-246A-4	R8	246	132	234	132	350
ACQ580-01-293A-4	R8	293	160	278	160	418
ACQ580-01-363A-4	R9	363	200	345	200	498
ACQ580-01-430A-4	R9	430	250	400	200	545

Nominal ratings

I_N	Rated current available continuously without overloadability at 40 °C.
P_N	Typical motor power in no-overload use.

Maximum output current

I_{max}	Maximum output current. Available for 2 seconds at start, then as long as allowed by drive temperature.
-----------	---

Light-overload use

I_{Ld}	Continuous current allowing 110% I_{Ld} for 1 minute every 10 minutes at 40 °C.
P_{Ld}	Typical motor power in light-overload use.

The ratings apply for the frames R1 to R9 up to +40 °C in enclosed IP class 21/55.

For derating at high altitudes, temperatures or switching frequencies, see the user's HW manual, document code: 3AXD50000035866.

Ratings, types and voltages

ACQ580-04, drive modules



3-phase, $U_N = 400$ V (range 380 to 480 V). The power ratings are valid at nominal voltage 400 V (250 to 500 kW)

Drive type	Frame size	Nominal ratings		Light-overload use		Maximum output current
		I_N (A)	P_N (kW)	I_{Ld} (A)	P_{Ld} (kW)	I_{Max} (A)
ACQ580-04-505A-4	R10	505	250	485	250	560
ACQ580-04-585A-4	R10	585	315	575	315	730
ACQ580-04-650A-4	R10	650	355	634	355	730
ACQ580-04-725A-4	R11	725	400	715	400	1020
ACQ580-04-820A-4	R11	820	450	810	450	1020
ACQ580-04-880A-4	R11	880	500	865	500	1100

Nominal ratings

I_N	Rated current available continuously without overloadability at 40 °C.
P_N	Typical motor power in no-overload use.

Maximum output current

I_{max}	Maximum output current. Available for 2 seconds at start, then as long as allowed by drive temperature.
-----------	---

Light-overload use

I_{Ld}	Continuous current allowing 110% I_{Ld} for 1 minute every 10 minutes at 40 °C.
P_{Ld}	Typical motor power in light-overload use.

The ratings apply for the frames R10 to R11 up to +40 °C in enclosed IP class 00/20.

For derating at high altitudes, temperatures or switching frequencies, see the user's HW manual, document code: 3AXD50000048677.

Ratings, types and voltages

ACQ580-07, cabinet-built drives



3-phase, $U_N = 400$ V (range 380 to 480 V). The power ratings are valid at nominal voltage 400 V (75 to 250 kW)

Drive type	Frame size	Nominal ratings		Light-overload use		Maximum output current
		I_N (A)	P_N (kW)	I_{Ld} (A)	P_{Ld} (kW)	I_{Max} (A)
ACQ580-07-0145A-4	R6	145	75	138	75	178
ACQ580-07-0169A-4	R7	169	90	161	90	247
ACQ580-07-0206A-4	R7	206	110	196	110	287
ACQ580-07-0246A-4	R8	246	132	234	132	350
ACQ580-07-0293A-4	R8	293	160	278	160	418
ACQ580-07-0363A-4	R9	363	200	345	200	498
ACQ580-07-0430A-4	R9	430	250	400	200	545
ACQ580-07-0505A-4	R10	505	250	485	250	560
ACQ580-07-0585A-4	R10	585	315	575	315	730
ACQ580-07-0650A-4	R10	650	355	634	355	730
ACQ580-07-0725A-4	R11	725	400	715	400	1020
ACQ580-07-0820A-4	R11	820	450	810	450	1020
ACQ580-07-0880A-4	R11	880	500	865	500	1100

Nominal ratings

I_N	Rated current available continuously without overloadability at 40 °C.
P_N	Typical motor power in no-overload use.

Maximum output current

I_{max}	Maximum output current. Available for 2 seconds at start, then as long as allowed by drive temperature.
-----------	---

Light-overload use

I_{Ld}	Continuous current allowing 110% I_{Ld} for 1 minute every 10 minutes at 40 °C.
P_{Ld}	Typical motor power in light-overload use.

The ratings apply for the frames R6 to R11 up to +40 °C in enclosed IP class 21/42/54.

For derating at high altitudes, temperatures or switching frequencies, see the user's HW manual, document code: 3AXD50000045817.

Ratings, types and voltages

ACQ580-31, ultra-low harmonic drives



3-phase, $U_N = 400$ V (range 380 to 480 V). The power ratings are valid at nominal voltage 400 V (4 to 110 kW)

Drive type	Frame size	Nominal ratings		Light-overload use		Maximum output current
		I_N (A)	P_N (kW)	I_{Ld} (A)	P_{Ld} (kW)	I_{Max} (A)
ACQ580-31-09A5-4	R3	9.4	4	8.9	4	12.2
ACQ580-31-12A7-4	R3	12.6	5.5	12	5.5	16.1
ACQ580-31-018A-4	R3	17	7.5	16	7.5	21.4
ACQ580-31-026A-4	R3	25	11	24	11	28.8
ACQ580-31-033A-4	R6	32	15	30	15	42.5
ACQ580-31-039A-4	R6	38	18.5	36	18.5	54.4
ACQ580-31-046A-4	R6	45	22	43	22	64.6
ACQ580-31-062A-4	R6	62	30	59	30	77.5
ACQ580-31-073A-4	R6	73	37	69	37	105.4
ACQ580-31-088A-4	R6	88	45	84	45	124.1
ACQ580-31-106A-4	R8	106	55	101	55	149.6
ACQ580-31-145A-4	R8	145	75	138	75	181.3
ACQ580-31-169A-4	R8	169	90	161	90	246.5
ACQ580-31-206A-4	R8	206	110	196	110	287.3

Nominal ratings

I_N	Rated current available continuously without overloadability at 40 °C.
P_N	Typical motor power in no-overload use.

Maximum output current

I_{max}	Maximum output current. Available for 2 seconds at start.
-----------	---

Light-overload use

I_{Ld}	Continuous current allowing 110% I_{Ld} for 1 minute every 10 minutes at 40 °C.
P_{Ld}	Typical motor power in light-duty use.

The ratings apply for frames R3, R6 and R8 up to +40 °C in enclosed IP class 21/55.

For derating at higher altitudes, temperatures or switching frequencies, see the HW manual, document code 3AXD50000045935.

Ratings, types and voltages

ACQ580-34, ultra-low harmonic drives



3-phase, $U_N = 400$ V (range 380 to 480 V). The power ratings are valid at nominal voltage 400 V (132 to 355 kW)

Drive type	Frame size	Nominal ratings		Light-overload use		Maximum output current
		I_N (A)	P_N (kW)	I_{Ld} (A)	P_{Ld} (kW)	I_{Max} (A)
ACQ580-34-246A-4	R11	246	132	234	132	350.2
ACQ580-34-293A-4	R11	293	160	278	160	418.2
ACQ580-34-365A-4	R11	365	200	347	200	498.1
ACQ580-34-442A-4	R11	442	250	420	250	620.5
ACQ580-34-505A-4	R11	505	250	480	250	631.3
ACQ580-34-585A-4	R11	585	315	556	315	751.4
ACQ580-34-650A-4	R11	650	355	618	355	858.5

Nominal ratings

I_N Rated current available continuously without overloadability at 40 °C.

P_N Typical motor power in no-overload use.

Maximum output current

I_{max} Maximum output current. Available for 2 seconds at start.

Light-overload use

I_{Ld} Continuous current allowing 110% I_{Ld} for 1 minute every 10 minutes at 40 °C.

P_{Ld} Typical motor power in light-duty use.

The ratings apply for frame R11 up to +40 °C in enclosed IP class 00/20.

For derating at higher altitudes, temperatures or switching frequencies, see the HW manual, document code 3AXD50000420035.

Dimensions

ACQ580-01, IP21 and IP55

Frames	Height IP21 ^{*)} /IP55 ^{*)} (mm)	Width IP21/IP55 (mm)	Depth IP21 (mm)	Depth IP55 (mm)	Weight IP21 (kg)	Weight IP55 (kg)
R1	373/403	125/128	223	233	4.6	4.8
R2	473/503	125/128	229	239	6.6	6.8
R3	490	203/206	229	237	11.8	13
R4	636	203	257	265	19	20
R5	732	203	295	320	28.3	29
R6	727	252	369	380	42.4	43
R7	880	284	370	381	54	56
R8	965	300	393	452	69	77
R9	955	380	418	477	97	103

^{*)} Front height of the drive with glandbox



ACQ580-04

Frames	Height (mm)	Width (mm)	Depth (mm)	Weight (kg)
R10	1432	350	529	162
R11	1662	350	529	200

ACQ580-07

Frames	Height IP21 (mm)	Width IP21 (mm)	Depth IP21 (mm)	Weight IP21 (mm)
R6	2145	430	673	210
R7	2145	430	673	220
R8	2145	530	673	255
R9	2145	530	673	275
R10	2145	830	698	535
R11	2145	830	698	581



ACQ580-31, IP21 and IP55

Frames	Height (mm)	Width (mm)	Depth IP21 (mm)	Depth IP55 (mm)	Weight IP21 (kg)	Weight IP55 (kg)
R3	495	205	354	360	21.3	21.3
R6	771	252	392	449	61	63
R8	965	300	438	496	112	118



ACQ580-34, IP00

Frames	Height (mm)	Width (mm)	Depth IP00 (mm)	Weight IP00 (kg)
R11	1722	636.5	504.5	365

Comprehensive connectivity

The ACQ580 drives offer a wide range of standard interfaces. In addition, the drive has two option slots that can be used for extensions including fieldbus adapter modules and input/output extension modules.

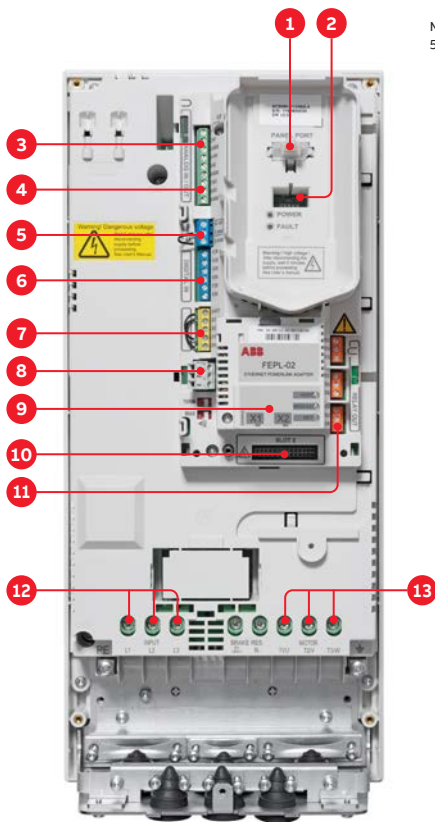

1. Panel port (PC tools, control panel)
2. ABB drive customizer port for programming the drive without mains
3. Analog inputs (2 × AI)
4. Analog outputs (2 × AO)
5. 24 V AC/DC output
6. Digital inputs (6 × DI)
7. Safe torque off (STO)
8. Embedded fieldbus
9. Communication options (fieldbuses)
10. I/O extensions
11. Relay outputs (3 × RO)
12. Mains connection
13. Motor connection

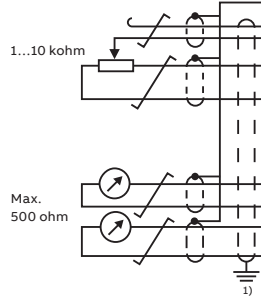

Default control connections

Terminal	Meaning	Default connections	
X1 Reference voltage and analog inputs and outputs			
1	SCR	Signal cable shield (screen)	
2	AI1	Output frequency/speed reference: 0 to 10 V	
3	AGND	Analog input circuit common	
4	+10 V	Reference voltage 10 V DC	
5	AI2	Actual feedback: 0 to 20 mA	
6	AGND	Analog input circuit common	
7	AO1	Output frequency: 0 to 10 V	
8	AO2	Motor current: 0 to 20 mA	
9	AGND	Analog output circuit common	
X2 & X3 Aux. voltage output and programmable digital inputs			
10	+24 V	Aux. voltage output +24 V DC, max. 250 mA	
11	DGND	Aux. voltage output common	
12	DCOM	Digital input common for all	
13	DI1	Stop (0)/Start (1)	
14	DI2	Not configured	
15	DI3	Constant frequency/speed selection	
16	DI4	Start interlock 1 (1 = allow start)	
17	DI5	Not configured	
18	DI6	Not configured	
X6, X7, X8 Relay outputs			
Ready run	19 RO1C	Ready run 250 V AC/30 V DC 2 A	Ready run 19 connected to 21
	20 RO1A		
	21 RO1B		
Run status	22 RO2C	Running 250 V AC/30 V DC 2 A	Running 22 connected to 24
	23 RO2A		
	24 RO2B		
Fault status	25 RO3C	Fault (-1) 250 V AC/30 V DC 2 A	Fault condition 25 connected to 26
	26 RO3A		
	27 RO3B		
X5 Embedded fieldbus			
29	B+	Embedded fieldbus, EFB (EIA-485)	
30	A-		
31	DGND		
S4	TERM	Termination switch	
S5	BIAS	Bias resistors switch	
X4 Safe torque off			
34	OUT1	Safe torque off. Factory connection. Both circuits must be closed for the drive to start. See chapter <i>The Safe torque off function</i> in the <i>hardware manual</i> of the drive.	
35	OUT2		
36	SGND		
37	IN1		
38	IN2		
X10 24 V AC/DC			
40	24 V AC/DC+ in	R6 to R11 and all ACQ580-31: Ext. 24 V AC/DC input to power up the control unit when the main supply is disconnected.	
41	24 V AC/DC- in		

Notes:

- 1) Ground the outer shield of the cable 360° under the grounding clamp on the grounding shelf for the control cables.
- 2) Connected with jumpers at the factory.

Hand-Off-Auto control panel

The control panel features intuitive use and easy navigation. High resolution display enables visual guidance.

Almost anyone can set up and commission the ACQ580 drive using available control panels. You do not need to know any drive parameters, as the control panel helps you to set up the essential settings quickly and get the drive into action.

Control of multiple drives

One control panel can be connected to several drives simultaneously using the panel network feature. The user can also select the drive to operate in the panel network.



1. With the customizable **Home views**, you can monitor the values that matter most, e.g. speed, torque or motor temperature. Select the signals from a ready-made list or choose user-defined parameters.
2. **Options** are used to set a reference, change the motor direction, select the drive, edit Home view pages, and see the fault and warning status.
3. All functions of the control panel are accessed through the **main menu**. It is possible to organize parameters in different ways and store essential parameters for different configurations for any specialized application needed.
4. The help key provides context-sensitive guidance. Faults or warnings can be resolved quickly since the help key provides troubleshooting instructions.
5. The PC tool can be easily connected to the drive through the **USB connector** on the control panel.

Assistant control panel display

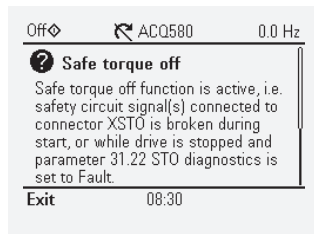

01

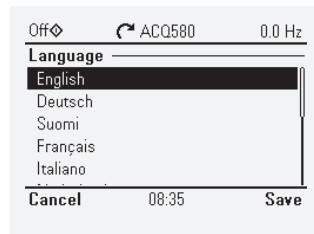

02

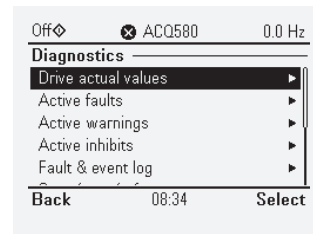

03

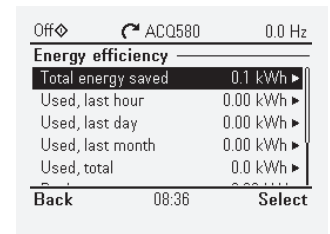

04

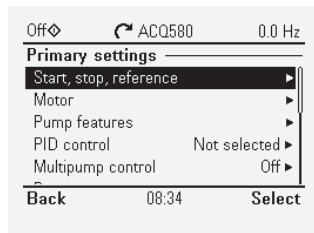

05

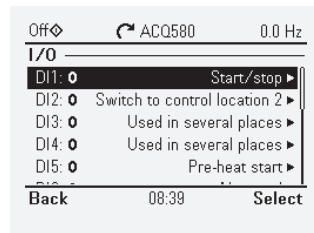

06

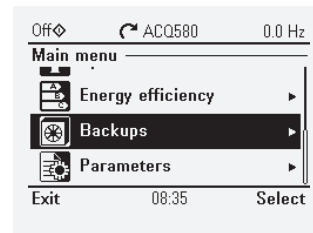

07

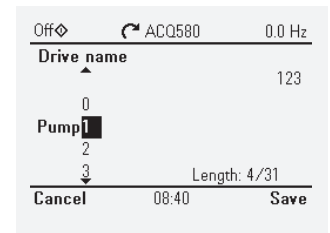

08

01 Help button

- Detailed descriptions related to faults and warnings
- More information about Primary settings options

02 Language options

Access to a selection list that consists of mutually exclusive options such as the language selection list (Access through the main menu).

03 Diagnostics

- Diagnostic information, such as faults and warnings
- Helps to resolve potential problems
- Helps to make sure that the drive setup is functioning correctly

04 Energy efficiency

View and configure parameters related to energy savings, such as kWh counters.

05 Primary settings for ACQ580

With the primary settings you can set motor values, commission multipump, set level control, set soft pipe filling etc. pumping features. When using Primary settings, there is no need to browse the parameters.

06 I/O Menu

- Access to each terminal name, number and electrical status
- Possibility to force inputs and outputs
- Access to sub-menus that provides further information on the menu item and allow to make changes to the I/O connections

07 Backups

Possibility to save parameter settings in the control panel memory and restore parameter settings from a backup to the drive.

08 Text editor

Add information, customize text and label the drive.

Effortless drive commissioning and use with control panels

A variety of different control panel variants and panel accessories are available for the ACQ580 drives. Drive setup, maintenance, diagnostics and process monitoring is done via the control panel in an effortless manner.



01



02



03



04



05



06

01 Hand-Off-Auto control panel and Help function are included as standard. USB connection as standard.

02 The optional Hand-Off-Auto control panel with Bluetooth functionality. USB connection as standard.

03 By using the panel bus adapter, CDPI-01 the assistant control panel is able to manage up to 32 drives.

04 The DPMP-01 control panel mounting platform is for flush mountings. It does not include the control panel. When using this with ACQ580, also CDPI-01 is required.

05 The DPMP-02 mounting platform is for surface mounting. It does not include the control panel. When using this with ACQ580, also CDPI-01 is required.

06 The door mounting kit DPMP-EXT is a ready-made kit consisting of the DPMP-02 and CDPI-01.

Control panel options

Option code	Description	Type designation
+J400	The Hand-Off-Auto control panel as standard in the delivery	ACH-AP-H
+J429	Control panel with Bluetooth interface	ACH-AP-W
+J425	Assistant Control panel with local/remote -logic	ACS-AP-I
+J424	Blank control panel cover (no control panel delivered)	CDUM-01
3AXD50000004419	Panel bus adapter	CDPI-01
3AUA0000108878	Control panel mounting platform (flush mounted, requires also panel bus adapter on the drive)	DPMP-01
3AXD50000009374	Control panel mounting platform (surface mounted, requires also panel bus adapter on the drive)	DPMP-02
3AXD50000016230 *)	Control panel mounting platform (surface mounted, requires also panel bus adapter on the drive, only for ACQ580-04/34)	DPMP-03
3AXD50000217717 *)	Control panel mounting kit for outdoor installation	DPMP-04
3AXD50000240319 *)	Control panel mounting kit for outdoor installation, only for ACQ580-04/34	DPMP-05
3AXD50000010763	Door mounting kit for the panel (for one drive, contains both DPMP-02 and CDPI-01)	DPMP-EXT

*) For availability please contact your local ABB

ABB Ability™ smartphone apps

Better connectivity and user experience with Drivetune

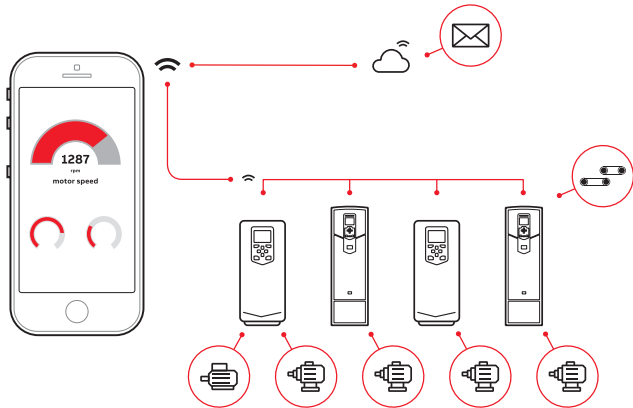

Easy and fast access to product information and support



Startup, commission and tune your drive and application



Instantly access drive status and configuration with a simplified user guidance

Services and support on the go with Drivebase

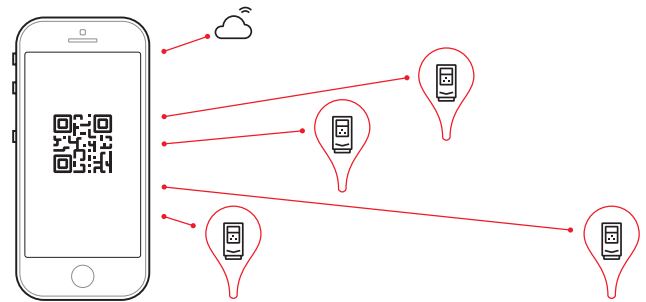

Search for support documents and contacts



Access your product and service information in the cloud from anywhere



View your drives installed base and plan service activities



Optimize performance via drive troubleshooting features



Create and share backups and support packages



Use dynamic QR code to troubleshoot your drive



Report service events

Access information anywhere

Download the apps using the QR codes below or directly from the app stores



Drivetune for commissioning and managing drives



Drivebase for ensured reliability and reduced downtime on production sites

High protection for operation in harsh environments

The ACQ580 can be installed in normal equipment rooms, or even dusty and wet environments, thanks to the drive's compact (or optimized) wall-mountable construction in both IP21 and IP55 configurations. The module variant is as standard IP00 but available as IP20 with additional finger shrouds. The cabinet-built variant comes with IP21 as standard and is also available with IP42 and IP54 protection class for use in harsh environments.

Option code	Description
+B051	IP20 finger shrouds for modules
+B054 +B055	IP42, IP54 for cabinet-built drives
+B056	IP55 for wall-mountable drives

The robust and protective design ensures that no additional enclosures or components, such as filters and fans, are needed. Overall, the harsh protection drives provide smaller capital expenses by avoiding or advancing maintenance of external components, which in turn improves the reliability of the drive and the process. To ensure reliable operation, the printed circuit boards are also offered with coating to comply with class 3C3 in ACQ580-01 IP55 drives.

Option code	Description
+C218 +B056	3C3 rated PCBs

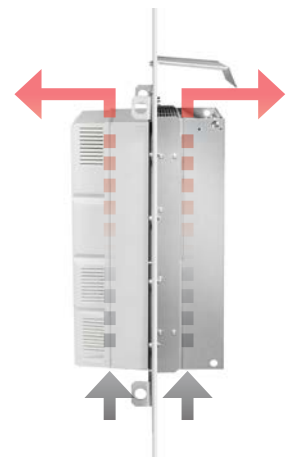

Flange mounting

The ACQ580 wall-mounted drive offers flange mounting as an option, separating the control electronics from the main circuit cooling airflow, saving space and ensuring optimal cooling. This results in better thermal management in panel installation.

Option code	Description
+C135	Flange mounting

Advanced cooling

The simple and robust design of the ACQ580-07 ensures reliable operation even in the harsh environments. The flange mounting feature comes as standard for cabinet-built ACQ580 drive, which makes the whole cooling arrangement of the cabinet advanced.

Quick configuration for unpowered drives

—
Cold configuration
adapter CCA-01



Cold configuration adapter CCA-01 provides a serial communication interface for unpowered ACQ580 drives, among other selected drives. With the adapter and Drive Composer PC tool you can set the parameters and pre-configure the drive before sending it to site. The panel makes it also possible to isolate both the serial communication and power supply of the control unit. The power supply is taken from a PC USB port.

—
Cold configurator adapter

Ordering code	Description	Type designation
3AXD50000019865	Cold configurator adapter, packed kit	CCA-01

PC tool for drive monitoring and process tuning capabilities

The Drive composer PC tool offers fast and harmonized setup, commissioning and monitoring for the whole all-compatible drives portfolio. The free version of the tool provides startup and maintenance capabilities and gathers all drive information such as parameter loggers, faults, backups and event lists into a support diagnostics file with a single mouse click. This provides faster fault tracking, shortens downtime and reduces operational and maintenance costs. The entry version also includes AP programming.

—
The Drive composer
PC tool



The Drive composer tool is connected to the drive using the mini USB connection on the assistant control panel or to the CCA-01 adapter.

—
Remote monitoring
tool NETA-21



Drive composer pro offers extended functionality

Drive composer pro provides additional features such as custom parameter windows, graphical control diagrams of the drive's configuration and improved monitoring and diagnostics. The control diagrams save users from browsing long lists of parameters and help set the drive's logic quickly and easily. The tool has fast monitoring capabilities of multiple signals from several drives in the panel bus. Full backup and restore functions are also included.

Remote monitoring access worldwide

The remote monitoring tool, NETA-21, gives easy access to the drive via the Internet or local Ethernet network. NETA-21 comes with a built-in web server. Compatible with standard web browsers, it ensures easy access to a web-based user interface. Through the web interface, the user can configure drive parameters, monitor drive log data, load levels, run time, energy consumption, I/O data and bearing temperatures of the motor connected to the drive.

—
Remote monitoring option

Ordering code	Description	Type designation
3AUA0000094517	2 x panel bus interface, 2 x 32 = max. 64 drives 2 x Ethernet interface SD memory card USB port for WLAN/3G	NETA-21

Flexible connectivity to automation

—
ACQ580 is compatible with many fieldbus protocols and input/output extension modules



—
Fieldbus module FDNA-01



Fieldbus adapters

Option code	Fieldbus protocol	Adapter
+ K454	PROFIBUS-DP	FPBA-01
+ K451	DeviceNet	FDNA-01
+ K457	CANopen	FCAN-01
+ K458	Modbus/RTU	FSCA-01
+ K490	Two-Port EtherNet/IP™ Adapter	FEIP-21
+ K491	Two-Port Modbus/TCP Adapter	FMBT-21
+ K492	Two-Port PROFINET IO Adapter	FPNO-21

—
02 Input/output extension module CMOD-01



I/O options

Option code	Description	Type designation
+L501	External 24 V AC and DC 2 x RO and 1 x DO	CMOD-01
+L523	External 24 V and isolated PTC interface	CMOD-02
+L512	115/230 V digital input 6 x DI and 2 x RO	CHDI-01

The drives for water and wastewater are compatible with a wide range of fieldbus protocols. The drive comes with a Modbus RTU fieldbus interface as standard. Optional fieldbus adapters can easily be mounted inside the drive.

Drive monitoring

The drive monitors and controls its parameters and signals including speed, torque, power, speed reference and pressure reference. Start/stop is monitored and controlled via the drives communication protocols. A set of drive parameters and/or actual signals, such as torque, speed, current, etc., can be selected for cyclic data transfer, providing fast data access.

Drive diagnostics

Accurate and reliable diagnostic information can be obtained through the alarm, limit and fault words, allowing easy interfacing with plantwide HMIs.

Cabling

Substituting the large amount of conventional drive control cabling and wiring with a single cable reduces costs and increases system reliability and flexibility.

Design

The use of a fieldbus control reduces engineering time at installation due to the modular structure of the hardware and software and the simplicity of the connections to the drives.

Commissioning and assembly

The modular product configuration allows precommissioning of single machine sections and provides easy and fast assembly of the complete installation.

Input/output extension modules

Standard input and output can be extended by using optional analog and digital input/output extension modules. The modules are easily installed in the extension slots located on the drive. The CMOD options also enable connection to an external +24 V supply, which allows the control panel, control board, fieldbus and I/O to stay on when mains supply is cut off. With the external supply, drive diagnosis and fault finding can still be carried out.

Thermistor protection modules for increased safety

ACQ580 supports the ATEX certified thermistor protection module, EX II (2) GD



Thermistor protection module

Option code	Description	Type designation
+L537 +Q971	ATEX certified PTC interface, EX II (2) GD and external 24V	CPTC-02

Standard input and output can be extended by using optional digital input/output extension modules. The modules are easily installed in the extension slot located on the drive. The CMOD options also enable connection to an external +24 V supply, which allows the control panel, control board, fieldbus and I/O to stay on when main supply is cut off. With the external supply, drive diagnosis and fault tracing can still be carried out.

The ATEX certified thermistor protection module CPTC-02 provides enhanced process safety and easy, simplified installation.

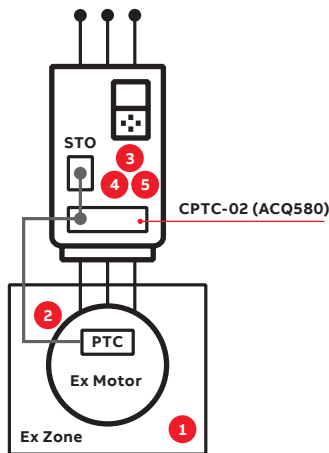

ABB's ATEX thermistor protection module, EX II (2) GD, CPTC-02

With the option +L537 +Q971:

1. Motor temperature rises above the PTC sensor limit temperature
2. The sensor resistance increases very sharply and indicates overheating to the ATEX-certified module
3. The module switches the STO (safe torque off) circuit off, which activates the STO function
4. The STO function disables the control voltage in the power semiconductors of the drive output stage
5. The drive is prevented from generating torque to rotate the motor

► The safe state is guaranteed

Main disconnect switch for increased safety

—
Main disconnect
switch possibility
to disconnect the
drive from the
main supply



Main disconnect switch

The main disconnect switch option provides a possibility to disconnect the drive from the main supply when needed. This prewired main disconnect switch option saves time, money and space as it is integrated in the drive. There is no need to install an additional, external isolation devices to the supply side of the drive. The option improves safety as it is always visible, when operating on the drive.

Auxiliary contact allows signalling the switch position to PLC to avoid unnecessary controller alarms. The switch can be padlocked to open position to disable drive operation during e.g. maintenance.

— Main disconnect switch

Option code	Description
+B056 +F278	ACQ580-01 IP55 drive and main disconnect switch with auxiliary contact (NO)

EMC – electromagnetic compatibility

The ACQ580 drive has been designed to meet the EMC requirements set in the product standard IEC/EN61800-3. The wall-mounted ACQ580-01, ACQ580-31 and the small power cabinet-built ACQ580-07 drives meet category C2 high frequency emission limits as standard. The single standing drive module ACQ580-04, ACQ580-34 and high power ACQ580-07 cabinet-built drives meet category C3 limits without options.

EMC standards

The EMC product standard (EN 61800-3) covers the specific EMC requirements stated for drives (tested with motor and motor cable) within the EU. EMC standards such as EN 55011 or EN 61000-6-3/4 are applicable to industrial and domestic equipment and systems including components inside the drive. Drive units complying with the requirements of EN 61800-3 are compliant with comparable categories in EN 55011 and EN 61000-6-3/4, but not necessarily vice versa. EN 55011 and EN 61000-6-3/4 do not specify cable length or require a motor to be connected as a load. The emission limits are comparable to EMC standards according to the table below.

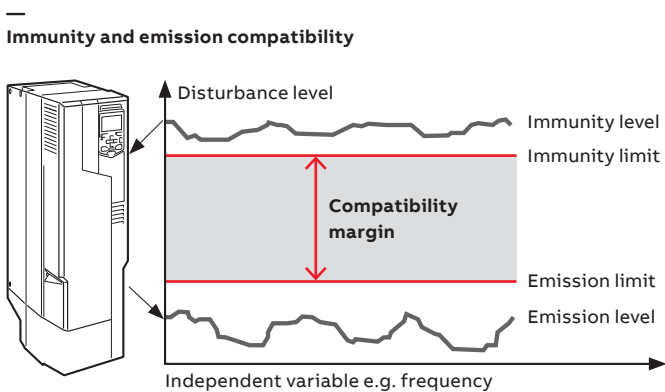

Domestic environments versus public low voltage networks

1st environment includes domestic premises. It also includes establishments directly connected without an intermediate transformer to a low voltage power supply network that supplies buildings used for domestic purposes. 2nd environment includes all establishments directly connected to public low voltage power supply networks.

Built-in chokes to mitigate harmonics

ACQ580 drives are equipped with built-in chokes which provide sufficient level of harmonic mitigation for most operation environments. The ACQ580-31 ultra-low harmonic drives are available for cases where extremely good low harmonic mitigation is required.

Comparison of EMC standards				
EMC according to EN 61800-3 product standard	EN 61800-3 product standard	EN 55011. product family standard for industrial, scientific and medical (ISM) equipment	EN 61000-6-4, generic emission standard for industrial environments	EN 61000-6-3, generic emission standard for residential, commercial and light-industrial environment
1 st environment. unrestricted distribution	Category C1	Group 1. Class B	Not applicable	Applicable
1 st environment. restricted distribution	Category C2	Group 1. Class A	Applicable	Not applicable
2 nd environment. unrestricted distribution	Category C3	Group 2. Class A	Not applicable	Not applicable
2 nd environment. restricted distribution	Category C4	Not applicable	Not applicable	Not applicable



du/dt filters

du/dt filtering suppresses inverter output voltage spikes and rapid voltage changes that stress motor insulation. Additionally, du/dt filtering reduces capacitive leakage currents and high frequency emission of the motor cable as well as high frequency losses and bearing currents in the motor. The need for du/dt filtering depends on the motor insulation. For information on the construction of the motor insulation, consult the manufacturer. More information on the du/dt filters can be found in the ACQ580 hardware manual.



du/dt filter selection

External du/dt filters

	du/dt filter type														
	Unprotected IP00							Protected to IP22				Protected to IP54			
	NOCH0016-60	NOCH0030-60	NOCH0070-60	NOCH0120-60	FOCH0260-70	FOCH0320-50	FOCH0610-70	NOCH0016-62	NOCH0030-62	NOCH0070-62	NOCH0120-62	NOCH0016-65	NOCH0030-65	NOCH0070-65	NOCH0120-65
ACQ580-31, 400 V															
ACQ580-31-09A5-4	•							•				•			
ACQ580-31-12A7-4	•							•				•			
ACQ580-31-018A-4	•*)	•						•*)	•			•*)	•		
ACQ580-31-026A-4		•							•				•		
ACQ580-31-033A-4			•							•				•	
ACQ580-31-039A-4			•							•				•	
ACQ580-31-046A-4			•							•				•	
ACQ580-31-062A-4			•							•				•	
ACQ580-31-073A-4			•*)	•						•*)	•			•*)	•
ACQ580-31-088A-4				•							•				•
ACQ580-31-106A-4				•							•				•
ACQ580-31-145A-4					•										
ACQ580-31-169A-4					•										
ACQ580-31-206A-4					•										
ACQ580-34, 400 V															
ACQ580-34-246A-4					•										
ACQ580-34-293A-4					•										
ACQ580-34-365A-4						•									
ACQ580-34-442A-4						•									
ACQ580-34-505A-4							•								
ACQ580-34-585A-4							•								
ACQ580-34-650A-4							•								

*) Filter can be used if full load current is not required

Cooling and fuses

Cooling

ACQ580 drives are fitted with variable-speed cooling fans. The speed-controlled fans cool the drive only when needed, reducing overall noise level and energy consumption.

Fuse connection

Standard fuses can be used with the ACQ580 drives. For input fuses, see the table below:

Wall-mounted drives, ACQ580-01

Cooling air flow and recommended input protection fuses for 380 to 415 V units

Type designation	Frame size	Cooling air flow 380 to 415 V units					Recommended input protection fuses for 380 to 415 V units ***)			
		Heat dissipation *)		Air flow		Max. noise level **)	IEC fuses		UL fuses	
		(W)	(BTU/Hr)	(m ³ /h)	(ft ³ /min)		(A)	Fuse type	(A)	Fuse type
ACQ580-01-02A7-4	R1	69	235	43	25	59	4	gG	15	UL Class T
ACQ580-01-03A4-4	R1	78	267	43	25	59	6	gG	15	UL Class T
ACQ580-01-04A1-4	R1	87	298	43	25	59	6	gG	15	UL Class T
ACQ580-01-05A7-4	R1	113	384	43	25	59	10	gG	15	UL Class T
ACQ580-01-07A3-4	R1	127	435	43	25	59	10	gG	15	UL Class T
ACQ580-01-09A5-4	R1	165	562	43	25	59	16	gG	15	UL Class T
ACQ580-01-12A7-4	R1	237	808	43	25	59	16	gG	15	UL Class T
ACQ580-01-018A-4	R2	265	907	101	59	64	25	gG	30	UL Class T
ACQ580-01-026A-4	R2	418	1426	101	59	64	32	gG	30	UL Class T
ACQ580-01-033A-4	R3	514	1756	179	105	76	40	gG	40	UL Class T
ACQ580-01-039A-4	R3	570	1947	179	105	76	50	gG	60	UL Class T
ACQ580-01-046A-4	R3	709	2422	179	105	76	63	gG	60	UL Class T
ACQ580-01-062A-4	R4	957	3269	134	79	69	80	gG	80	UL Class T
ACQ580-01-073A-4	R4	1230	4200	134	79	69	100	gG	100	UL Class T
ACQ580-01-088A-4	R5	1316	4496	139	82	63	100	gG	110	UL Class T
ACQ580-01-106A-4	R5	1589	5426	139	82	63	125	gG	150	UL Class T
ACQ580-01-145A-4	R6	2492	8509	435	256	67	160	gG	200	UL Class T
ACQ580-01-169A-4	R7	2536	8660	450	265	67	250	gG	225	UL Class T
ACQ580-01-206A-4	R7	3391	11580	450	265	67	315	gG	300	UL Class T
ACQ580-01-246A-4	R8	3945	13474	550	324	65	355	gG	350	UL Class T
ACQ580-01-293A-4	R8	5174	17670	550	324	65	425	gG	400	UL Class T
ACQ580-01-363A-4	R9	6294	21495	1150	677	68	500	gG	500	UL Class T
ACQ580-01-430A-4	R9	8231	28109	1150	677	68	630	gG	600	UL Class T

*) Heat dissipation value is a reference for cabinet thermal design.

**) The maximum noise level at full fan speed. When the drive is not operating at full load and at maximum ambient temperature the noise level is lower.

***) For detailed fuse sizes and types, please see the ACQ580-01 HW manuals, document code: 3AXD50000035866

Cooling and fuses

Drive modules, ACQ580-04

Cooling air flow and recommended input protection fuses for 380 to 415 V units

Type designation	Frame size	Cooling air flow 380 to 415 V units					Recommended input protection fuses for 380 to 415 V units ^{***)}				
		Heat dissipation ^{*)}		Air flow		Max. noise level ^{**)}	IEC fuses		UL fuses		
		(W)	(BTU/Hr)	(m ³ /h)	(ft ³ /min)		(A)	Fuse type	(A)	Fuse type	
ACQ580-04-505A-4	R10	7722	26374	1200	707	72	800	170M6812D	600	JJS-600	
ACQ580-04-585A-4	R10	8754	29896	1200	707	72	1000	170M6814D	800	A4BY800	
ACQ580-04-650A-4	R10	10378	35441	1200	707	72	1000	170M6814D	800	A4BY800	
ACQ580-04-725A-4	R11	10498	35854	1200	707	72	1250	170M8554D	800	A4BY800	
ACQ580-04-820A-4	R11	12678	43299	1200	707	72	1600	170M8557D	900	A4BY900	
ACQ580-04-880A-4	R11	14166	48380	1420	848	72	1600	170M8557D	1000	A4BY1000	

^{*)} Heat dissipation value is a reference for cabinet thermal design.

^{**)} The maximum noise level at full fan speed. When the drive is not operating at full load and at maximum ambient temperature the noise level is lower.

^{***)} For detailed fuse sizes and types, please see the ACQ580-04 HW manual 3AXD50000048677

Cabinet-built drives, ACQ580-07

Cooling air flow and recommended input protection fuses for 380 to 415 V units

Type designation	Frame size	Cooling air flow 380 to 415 V units					Recommended input protection fuses for 380 to 415 V units ^{***)}				
		Heat dissipation ^{*)}		Air flow		Max. noise level ^{**)}	IEC fuses		UL fuses		
		(W)	(BTU/Hr)	(m ³ /h)	(ft ³ /min)		(A)	Fuse type	(A)	Fuse type	
ACQ580-07-0145A-4	R6	2487	8485	685	982	67	250	170M3816D	250	DFJ-250	
ACQ580-07-0169A-4	R7	2497	8519	700	1004	67	250	170M3816D	300	DFJ-300	
ACQ580-07-0206A-4	R7	3314	11307	700	1004	67	315	170M3817D	300	DFJ-300	
ACQ580-07-0246A-4	R8	3806	12987	800	1147	65	400	170M5408	400	170M5408	
ACQ580-07-0293A-4	R8	4942	16863	800	1147	65	500	170M5410	500	170M5410	
ACQ580-07-0363A-4	R9	5868	20024	1400	2007	68	630	170M6410	630	170M6410	
ACQ580-07-0430A-4	R9	7600	25932	1400	2007	68	700	170M6411	700	170M6411	
ACQ580-07-0505A-4	R10	8353	28502	2950	1837	72	800	170M6412	800	W1046956F	
ACQ580-07-0585A-4	R10	9471	32317	2950	1837	72	900	170M6413	900	X1046957F	
ACQ580-07-0650A-4	R10	11200	38215	2950	1837	72	1000	170M6414	1000	Y1046958F	
ACQ580-07-0725A-4	R11	11386	38851	2950	1837	72	1250	170M6416	1250	A1046960F	
ACQ580-07-0820A-4	R11	13725	46831	2950	1837	72	1250	170M6416	1250	A1046960F	
ACQ580-07-0880A-4	R11	15300	52207	3170	1978	72	1400	170M6417	1400	B1046961F	

^{*)} Heat dissipation value is a reference for cabinet thermal design.

^{**)} The maximum noise level at full fan speed. When the drive is not operating at full load and at maximum ambient temperature the noise level is lower.

^{***)} For detailed fuse sizes and types, please see the ACQ580-07 HW manuals, document code: 3AXD50000045817

Ultra-low harmonic drives, ACQ580-31

Cooling air flow and recommended input protection fuses for 380 to 415 V units										
Type designation	Frame size	Cooling air flow 380 to 415 V units					Recommended input protection fuses for 380 to 415 V units ^{***)}			
		Heat dissipation ^{*)}		Air flow		Max. noise level ^{**)}	IEC fuses		UL fuses	
		(W)	(BTU/Hr)	(m ³ /h)	(ft ³ /min)		(A)	Fuse type	(A)	Fuse type
ACQ580-31-09A5-4	R3	226	772	361	212	57	16	gG	20	UL class T
ACQ580-31-12A7-4	R3	329	1124	361	212	57	16	gG	20	UL class T
ACQ580-31-018A-4	R3	395	1349	361	212	57	25	gG	35	UL class T
ACQ580-31-026A-4	R3	579	1977	361	212	57	32	gG	35	UL class T
ACQ580-31-033A-4	R6	625	2134	550	324	71	40	gG	60	UL class T
ACQ580-31-039A-4	R6	751	2565	550	324	71	50	gG	60	UL class T
ACQ580-31-046A-4	R6	912	3115	550	324	71	63	gG	60	UL class T
ACQ580-31-062A-4	R6	1088	3716	550	324	71	80	gG	110	UL class T
ACQ580-31-073A-4	R6	1502	5130	550	324	71	100	gG	110	UL class T
ACQ580-31-088A-4	R6	1904	6503	550	324	71	100	gG	110	UL class T
ACQ580-31-106A-4	R8	1877	6410	800	412	68	-	-	150	UL class T
ACQ580-31-145A-4	R8	2963	10119	800	412	68	-	-	200	UL class T
ACQ580-31-169A-4	R8	3168	10819	800	412	68	-	-	225	UL class T
ACQ580-31-206A-4	R8	3990	13627	800	412	68	-	-	300	UL class T

^{*)} Heat dissipation value is a reference for cabinet thermal design.

^{**)} The maximum noise level at full fan speed. When the drive is not operating at full load and at maximum ambient temperature the noise level is lower.

^{***)} For detailed fuse sizes and types, please see the ACQ580-31 HW manual 3AXD5000045935

Ultra-low harmonic drives, ACQ580-34

Cooling air flow and recommended input protection fuses for 380 to 415 V units										
Type designation	Frame size	Cooling air flow 380 to 415 V units					Recommended input protection fuses for 380 to 415 V units ^{***)}			
		Heat dissipation ^{*)}		Air flow		Max. noise level ^{**)}	IEC fuses		UL fuses	
		(W)	(BTU/Hr)	(m ³ /h)	(ft ³ /min)		(A)	Fuse type	(A)	Fuse type
ACQ580-34-246A-4	R11	5280	18032	2100	1279	72	-	-	400	aR ; Flush end
ACQ580-34-293A-4	R11	6400	21857	2100	1279	72	-	-	500	aR ; Flush end
ACQ580-34-365A-4	R11	8000	27321	2100	1279	72	-	-	630	aR ; Flush end
ACQ580-34-442A-4	R11	10000	34152	2100	1279	72	-	-	700	aR ; Flush end
ACQ580-34-505A-4	R11	10000	34152	2100	1279	72	-	-	800	aR ; Flush end
ACQ580-34-585A-4	R11	12600	43031	2100	1279	72	-	-	1000	aR ; Flush end
ACQ580-34-650A-4	R11	14200	48496	2100	1279	72	-	-	1000	aR ; Flush end

^{*)} Heat dissipation value is a reference for cabinet thermal design.

^{**)} The maximum noise level at full fan speed. When the drive is not operating at full load and at maximum ambient temperature the noise level is lower.

^{***)} For detailed fuse sizes and types, please see the ACQ580-34 HW manual 3AXD50000420025

Choose the motor for your water application

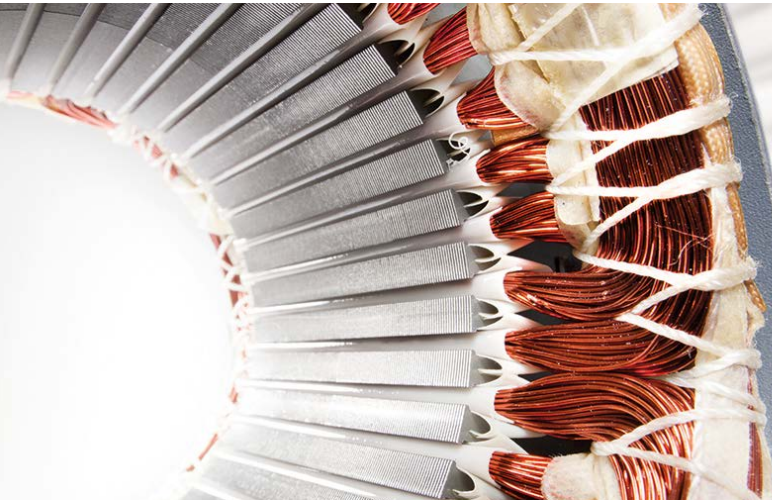

Induction motors and the ACQ580 form a reliable combination

Induction motors are used throughout the industry in many water and wastewater applications and in a wide range of environments. ACQ580 drives fit perfectly together with this type of motor by providing comprehensive functionality yet simple operation. IE3 motors and our drives provide a perfect foundation for energy efficiency, while delivering capabilities such as exceeding nominal motor speed when maximum power is needed.



Permanent magnet motors and the ACQ580 for smooth operation

Permanent magnet technology is used for improved motor characteristics in terms of energy efficiency and compactness. This technology is particularly well-suited for low speed control applications, as they eliminate the need to use gear boxes. Even without speed or rotor position sensors, the ACQ580 drives control most types of permanent magnet motors.

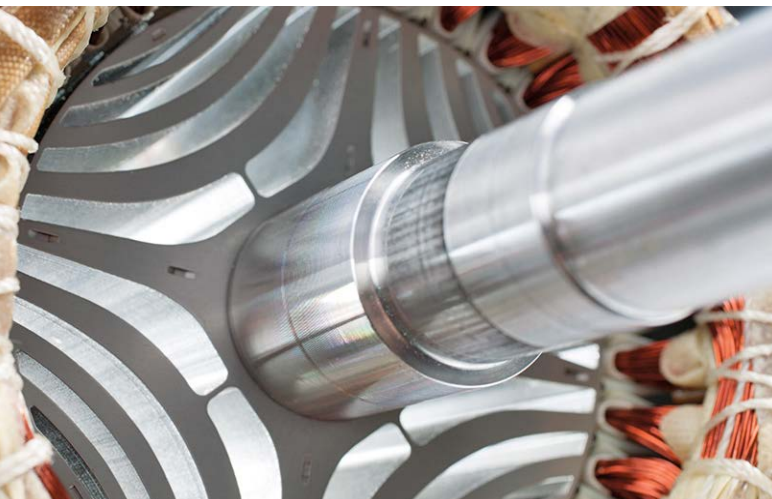

IE4 synchronous reluctance motors and the ACQ580 for optimized energy efficiency

Our drive and motor pairings guarantee your energy efficiency levels. The key is in the rotor design. Combining the ACQ580's control technology with our synchronous reluctance motors (SynRM) will give you a motor and a drive package that guarantees energy efficiency, reduces motor temperatures and provides a significant reduction in motor noise.

Ultimate efficiency and reliability to optimize your system's total cost of ownership

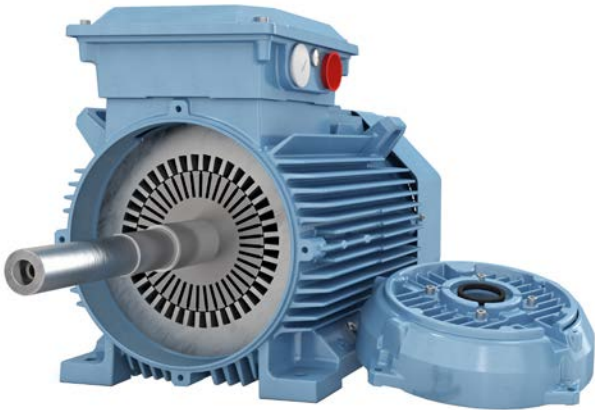

Traditional IE2 induction motor

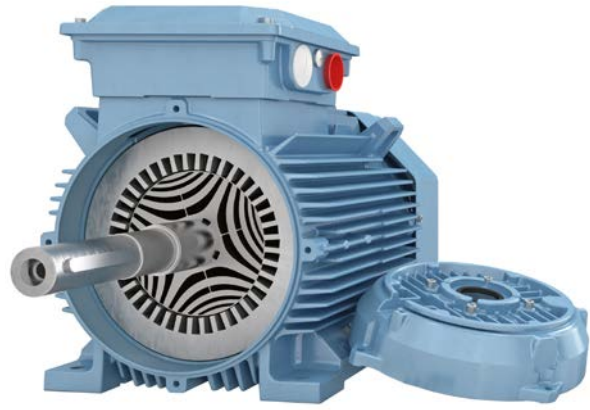

IE4 synchronous reluctance motor SynRM

Losses

Induction motor	I^2R Stator	Other	I^2R Rotor	100%
SynRM	I^2R Stator	Other		60%

Innovation inside

The idea is simple. Take a conventional, proven stator technology and a totally new, innovative rotor design. Then combine them with a dedicated water industry drive loaded with new, application-designed software. Most of the pumps are constantly running at partial loads due to conservative design. With the Synchronous reluctance motor (SynRM) the energy efficiency remains at excellent levels also at partial loads.

Magnet-free design

Synchronous reluctance technology combines the performance of the permanent magnet motor with the simplicity and service-friendliness of an induction motor. The new rotor has neither magnets nor windings and suffers virtually no power losses. And because of identical footprints, maintenance is as straightforward as with induction motors.

Superior reliability to minimize the cost of not running

IE4 synchronous reluctance motors have very low winding temperatures, which increases the reliability and lifetime of the winding. More importantly, the cool synchronous reluctance rotor means significantly lower bearing temperatures – an important factor because bearing failures cause about 70 percent of unplanned motor outages.



ABB automation products



AC500

ABB's powerful flagship PLC offering provides wide range of performance levels and scalability within a single simple concept where most competitors require multiple product ranges to deliver similar functionality.



AC500-S

A PLC based modular automation solution that makes it easier than before to mix and match standard and safety I/O modules to expertly meet your safety requirements in all functional safety applications. "Extreme conditions" version is also offered.



Programmability

Automation Builder integrates the engineering and maintenance for PLC, drives, motion, HMI and robotics. It complies with the IEC 61131-3 standard offering all five IEC programming languages for PLC and drive configuration. Automation Builder supports a number of languages and comes with new libraries. FTP functions, SMTP, SNMP, smart diagnostics and debugging capabilities.



AC motors

ABB's low voltage AC motors are designed to save energy, reduce operating costs and enable demanding motor applications to perform reliably and without unscheduled downtime. General performance motors combine convenience and easy handling seamlessly with ABB's engineering expertise. Process performance motors provide the most comprehensive.



AC500-eCo

Meets the cost-effective demands of the small PLC market while offering total inter-operability with the core AC500 range. Web server, FTP server and Modbus-TCP for all Ethernet versions. A Pulse Train Out-put module is available for multi-axis positioning.

AC500-XC

"Extreme conditions" modules with extended operating temperature, immunity to vibration and hazardous gases. for use at high altitudes, in humid conditions. etc. It replaces expensive cabinets with its built-in protection against dirt, water, gases and dust.



Control panels

Our control panels offer a wide range of touchscreen graphical displays from 3.5" up to 15". They are provided with user-friendly configuration software that enables tailor made customized HMI solutions. Rich sets of graphical symbols and the relevant drivers for ABB automation products are provided. Control panels for visualization of AC500 web server applications are available.



All-compatible drives portfolio

The all-compatible drives share the same architecture; software platform, tools, user interfaces and options. Yet, there is an optimal drive from the smallest water pump to the biggest cement kiln, and everything in the between. When you have learned to use one drive it, is easy use the other drives in the portfolio.



Water library package

ABB's water library is compatible with the AC500 series PLC's. They provide advance pumping functions, data logging, remote access and reliable data communication. The libraries ensure saved engineering time and costs as well as ease of use with fast programming possibilities.



Softstarters

ABB's softstarters increase a motor's lifetime by protecting it from electrical stresses. With everything that you need in one unit, from bypass contactor to overload protection, a single Softstarter makes for a compact and complete starting solution.



Securing the flow of water and wastewater in the pump system

We want to be part of securing the operation of your water and wastewater utilities and distribution system. We want to help prevent any interruptions in your pump operation. We also want to ensure that the water is flowing in an effortless and energy efficient manner in accordance with required standards and regulations.



Complete offering of devices and services for the water industry

As a global partner, we can manage your water assets and bring you clear benefits from a total cost of ownership perspective. We do this by reducing costs throughout the whole life cycle of your pumping solution. Our portfolio includes drives, motors, PLCs and sensors. We also offer remote monitoring solutions to access information from a pump operating at a distance, saving time and reducing costs. Our devices have been designed to be compatible with each other, which ensures reliable communication and functionality.

Proactive maintenance for minimizing disruption to your pump and water distribution system

Motor-driven applications can be found throughout the water and wastewater industry. They have a high degree of reliance placed upon them and often perform critical duties and have a high in-service value. A possible failure of a device in the water and wastewater distribution system can result in loss of production, and introduce safety and environmental consequences. To reduce the risk of failure, each element of the pump solution – whether a drive, motor, bearing, coupling or gearing – must be properly maintained at the right times in their life cycle. From the moment you make the first enquiry to the disposal and recycling of each component, the services offered by ABB span the entire life cycle of your pump. Throughout the value chain, training, technical support and customized contracts are also available.

Services to match your needs

Your service needs depend on your operations, the life cycle of your equipment, and your business priorities. We have identified our customers' four most common needs, and we created service options to satisfy them. Which will you choose to keep your drives at peak performance?

Is uptime your priority?

Keep your drives running with precisely planned and executed maintenance.

Example services include:

- ABB Ability™ Life Cycle Assessment
- Installation and Commissioning
- Spare Parts
- Preventive Maintenance
- Reconditioning
- ABB Drive Care agreement
- Drive Exchange



Operational efficiency

Is rapid response a key consideration?

If your drives need immediate action, our global network is at your service.

Example services include:

- Technical Support
- On-site Repair
- ABB Ability™ Remote Assistance
- Response time agreements
- Training



Rapid response

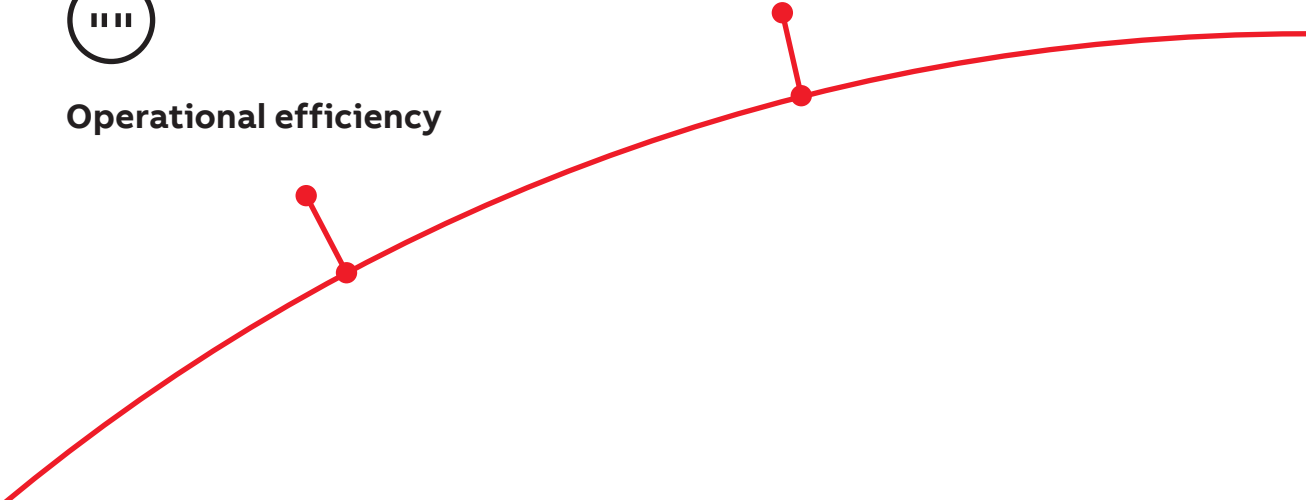

Drives service

Your choice, your future

The longevity of your drives is influenced by the service you choose.

Whatever you choose, it should be a well-informed decision. We have the expertise and experience to help you find and implement the right service for your drive equipment. Start by asking yourself these two critical questions:

- Why would my drive be serviced?
- What would my optimal service options be?

From here, count on our guidance and full support throughout the entire lifetime of your drives.

Your choice, your business efficiency

ABB Drive Care lets you focus on your core business. A selection of predefined service options matching your needs provides optimal, more reliable performance, extends your drive's lifetime, and controls costs. This reduces the risk of unplanned downtime and makes it easier to budget for maintenance.

We can help you more if we know where you are!

Register your drive for advanced services.

Need to extend your assets' lifetime?

Maximize the lifetime of your drive with our services.

Example services include:

- ABB Ability™ Life Cycle Assessment
- Upgrades, Retrofits and Modernization
- Replacement, Disposal and Recycling



Life cycle management

Is performance most critical to your operation?

Get optimal performance out of your machinery and systems.

Example services include:

- ABB Ability™ Remote Services
- Engineering and Consulting
- Inspection and Diagnostics
- Upgrades, Retrofits and Modernization
- Workshop Repair
- Tailored services



Performance improvement

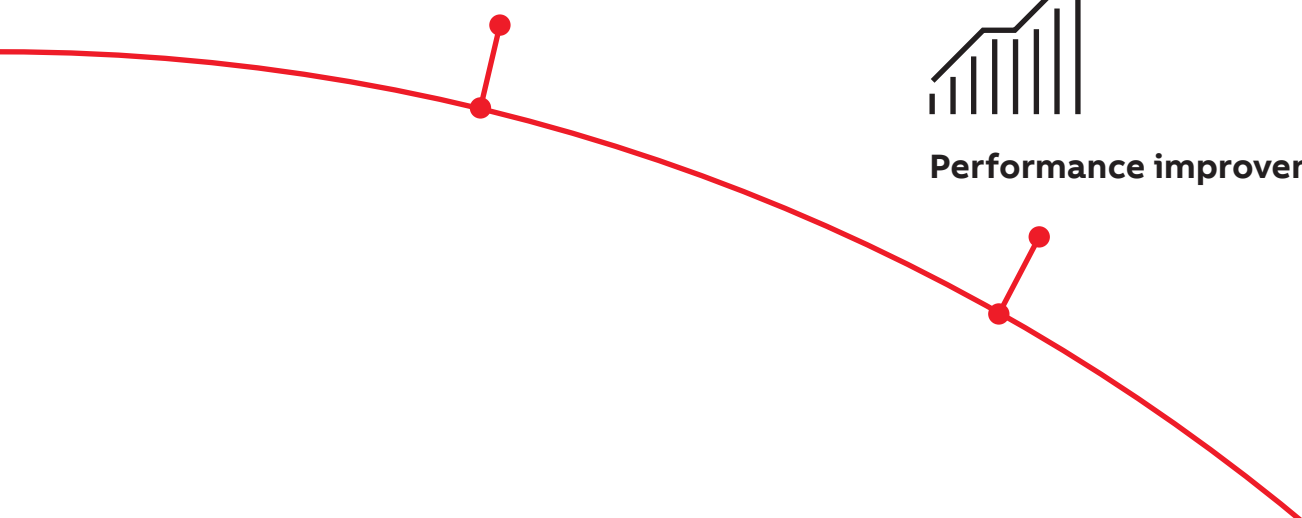

A lifetime of peak performance

You're in control of every life cycle phase of your drives. At the heart of drive services is a four-phase product life cycle management model. This model defines the services recommended and available throughout drives lifespan.

Now it's easy for you to see the exact service and maintenance available for your drives.

ABB drives life cycle phases explained:



Full range of life cycle services and support

Limited range of life cycle services and support

Replacement and end-of-life services

Product	Serial production has ceased. Product may be available for plant extensions, as a spare part or for installed base renewal.	Product is no longer available.	Product is no longer available.
	Services	Full range of life cycle services is available. Product enhancements may be available through upgrade and retrofit solutions.	Limited range of life cycle services is available. Spare parts availability is limited to available stock.

Keeping you informed

We notify you every step of the way using life cycle status statements and announcements.

Your benefit is clear information about your drives' status and precise services available. It helps you plan the preferred service actions ahead of time and make sure that continuous support is always available.

Step 1

Life Cycle Status Announcement

Provides early information about the upcoming life cycle phase change and how it affects the availability of services.

Step 2

Life Cycle Status Statement

Provides information about the drive's current life cycle status, availability of product and services, life cycle plan and recommended actions.

ABB Ability™ Condition Monitoring for drives



ABB Ability™ Condition Monitoring for Drives is a service that delivers you accurate, real-time information about drive events to ensure your equipment is available, reliable and maintainable. When you have the facts, you can make the right decisions.



Make best decisions

You know your process, we know the drives. Our monitoring system provides you with data and information from the drives for your best decisions.



Reduce the risks

You have the information when needed most. Our monitoring system is continuously collecting data for you to set warning limits and to trouble-shoot potential problems.



Available on your need

You can combine Remote Assistance Service with Condition Monitoring. Our experts will always be on hand to consult with you.



Check the service availability for your drive types with your local ABB representative.

Need help?

Contact ABB or third party channel company.

abb.com/drives/services

abb.com/searchchannels



—
For more information, please contact
your local ABB representative or visit

new.abb.com/drives
new.abb.com/drives/drivespartners
new.abb.com/motors-generators

Online manuals for wall-mounted ACQ580 drives



Online manuals for ACQ580 drive modules



Online manuals for cabinet-built ACQ580 drives



Online manuals for ACQ580-31 wall-mounted low-harmonic drives



Online manuals for ACQ580-34 low-harmonic drive modules

