**User's
Manual**

**CA700
Pressure Calibrator
User's Manual**

Thank you for purchasing the CA700 pressure calibrator. This user's manual explains the features, operating procedures, and handling precautions of the CA700. To ensure correct use, please read this manual thoroughly before beginning operation.

After reading this manual, keep it in a safe place. The following manuals, including this one, are provided as manuals for the CA700. Please read all manuals.

Manual Title	Manual No.	Description
CA700 Pressure Calibrator User's Manual	IM CA700-01EN	This manual. The manual explains all the CA700 features. It is included in the accompanying CD.
CA700 Pressure Calibrator Getting Started Guide	IM CA700-02EN	Provided as a printed manual. This guide explains the handling precautions, basic operations, and specifications of the CA700.

Notes

- The contents of this manual are subject to change without prior notice as a result of continuing improvements to the instrument's performance and functionality. The figures given in this manual may differ from those that actually appear on your screen.
- Every effort has been made in the preparation of this manual to ensure the accuracy of its contents. However, should you have any questions or find any errors, please contact your nearest YOKOGAWA dealer.
- Copying or reproducing all or any part of the contents of this manual without the permission of YOKOGAWA is strictly prohibited.

Trademarks

- Microsoft, Internet Explorer, Windows, Windows 7, Windows 8, and Windows 10 are either registered trademarks or trademarks of Microsoft Corporation in the United States and/or other countries.
- Adobe, Acrobat, and PostScript are either registered trademarks or trademarks of Adobe Systems Incorporated.
- HART is a registered trademark of HART Communication Foundation.
- In this manual, the TM and ® symbols do not accompany their respective registered trademark or trademark names.
- Other company and product names are registered trademarks or trademarks of their respective holders.

Revisions

- 1st Edition: August 2013
- 2nd Edition: September 2015
- 3rd Edition: June 2017
- 4th Edition: October 2017
- 5th Edition: October 2018
- 6th Edition: October 2019

Conventions Used in This Manual

Unit

k: Denotes 1000.

K: Denotes 1024.

Example: 100 kS/s (sample rate)

Example: 720 KB (file size)

Displayed Characters

Bold characters in procedural explanations are used to indicate panel keys and soft keys that are used in the procedure and menu items that appear on the screen.

Notes

The notes and cautions in this manual are categorized using the following symbols.



Improper handling or use can lead to injury to the user or damage to the instrument. This symbol appears on the instrument to indicate that the user must refer to the user's manual for special instructions. The same symbol appears in the corresponding place in the user's manual to identify those instructions. In the user's manual, the symbol is used in conjunction with the word "WARNING" or "CAUTION."

WARNING

Calls attention to actions or conditions that could cause serious or fatal injury to the user, and precautions that can be taken to prevent such occurrences.

CAUTION

Calls attention to actions or conditions that could cause light injury to the user or cause damage to the instrument or user's data, and precautions that can be taken to prevent such occurrences.

Note

Calls attention to information that is important for the proper operation of the instrument.

French



Une manipulation ou une utilisation incorrectes risquent de blesser l'utilisateur ou d'endommager l'instrument. Ce symbole apparaît sur l'instrument pour indiquer à l'utilisateur qu'il doit se reporter au manuel de l'utilisateur afin d'y lire les instructions spécifiques correspondantes. Ce même symbole apparaît à la section correspondante du manuel de l'utilisateur pour signaler lesdites instructions. Dans le manuel de l'utilisateur, ce symbole est accompagné des termes AVERTISSEMENT et ATTENTION.

AVERTISSEMENT

Attire l'attention sur des gestes ou des conditions susceptibles de provoquer des blessures graves (voire mortelles), et sur les précautions de sécurité pouvant prévenir de tels accidents.

ATTENTION

Attire l'attention sur des gestes ou des conditions susceptibles de provoquer des blessures légères ou d'endommager l'instrument ou les données de l'utilisateur, et sur les précautions de sécurité susceptibles de prévenir de tels accidents.

Contents

Conventions Used in This Manual	iii
Chapter 1 Features	
1.1 System Configuration	1-1
1.2 Pressure, DC Current, and DC Voltage Source and Measurement Functions.....	1-2
1.3 Calibration Feature	1-5
1.4 Saving Data	1-8
1.5 Communication Feature	1-10
1.6 USB Feature.....	1-11
1.7 Other Features	1-12
Chapter 2 Source and Measure	
2.1 Measuring Pressure	2-1
2.2 Measuring Leak Rates	2-8
2.3 Generating DC Current and DC Voltage	2-11
2.4 Measuring DC Current and DC Voltage	2-18
Chapter 3 Calibrating the Pressure Transmitter	
⚠ 3.1 Connecting to a Pressure Transmitter or Pressure Switch.....	3-1
3.2 Select the Calibration Procedure.....	3-3
3.3 Setting the Device Information and the Calibration Conditions of the Pressure Transmitter..	3-4
3.4 Calibrating the Pressure Transmitter	3-11
3.5 Setting the Calibration Conditions of the Pressure Switch	3-16
3.6 Calibrating a Pressure Switch	3-18
Chapter 4 Saving and Deleting Data	
4.1 Setting How to Save Measured Data	4-1
4.2 Deleting Files.....	4-4
4.3 Copying Files to a USB Storage Device.....	4-6
4.4 Formatting Internal Memory	4-9
Chapter 5 Remote Control	
5.1 Connecting the CA700 to Your PC	5-1
5.2 Setting the USB Parameters	5-2
5.3 List of Commands	5-4
5.4 Commands	5-5
5.5 Status Byte Format.....	5-19
5.6 Connecting the CA700 to Your PC as a USB Storage Device	5-20
Chapter 6 Other Settings	
6.1 Setting the Auto Power-Off Feature and LCD Contrast and Turning the LCD Backlight On and Off.....	6-1
6.2 Setting the HART Resistance and the Number of Pressure Display Digits.....	6-3
6.3 Setting the Decimal Point and the Separator for CSV Data	6-5
6.4 Holding Displayed Values and Displaying Min/Max Values.....	6-7
6.5 Reference Value and Relative Display	6-8
6.6 Setting the Language	6-9
6.7 Upgrading the Firmware Version of the Pressure Sensor	6-10

Contents

Chapter 7 Adjusting the CA700

7.1	Adjusting the Source Function	7-1
7.2	Adjusting the Measurement Function	7-4

Index

1.1 System Configuration

System Configuration

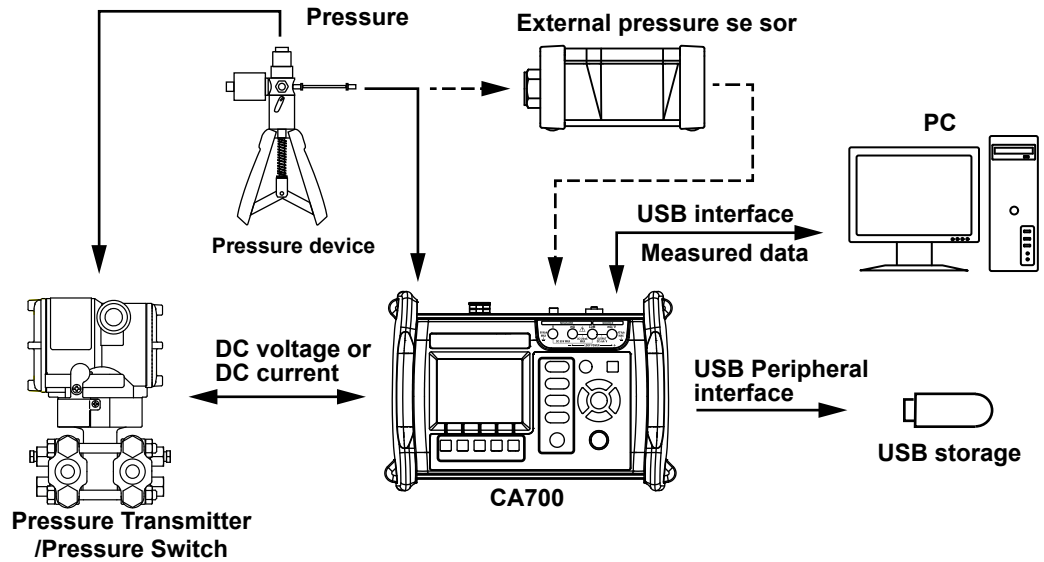

1.2 Pressure, DC Current, and DC Voltage Source and Measurement Functions

Pressure Measurement

Liquid and gas pressure can be measured.

Gauge Pressure Measurement and Absolute Pressure Measurement

There are two methods to measuring pressure: gauge pressure measurement, which takes atmospheric pressure to be zero, and absolute pressure measurement, which takes vacuum to be zero.

The CA700 comes in three types depending on the gauge pressure that can be measured.

CA700-*-01	–80 kPa to 200 kPa
CA700-*-02	–80 kPa to 1000 kPa
CA700-*-03	–80 kPa to 3500 kPa

Leak Rate Measurement

You can apply pressure to the device under measurement and measure the pressure over a given period to examine the pressure change caused by leakage.

The display shows the pressure at the start of measurement, the pressure at the end of measurement, the amount of pressure change, and the amount of pressure change per unit time (leak rate).

Zero Calibration

When the pressure sensor inside the CA700 is used to make measurements, measured values may be affected by the measuring environment and orientation of the CA700. Zero calibration (ZERO CAL) refers to the act of compensating for these effects.

A sensor inside the CA700 detects how much the CA700 is tilted. If the orientation is changed after a zero calibration is performed, the “ZERO CAL” indicator blinks to alert the user.

Combination with DC Current and DC Voltage Source and Measurement

DC current and DC voltage can be generated and measured simultaneously while pressure is being measured. However, during leak rate measurement, only leak rate measurement and generation are possible.

The possible combinations are (1) pressure measurement and DC current generation, (2) pressure measurement and DC voltage generation, (3) pressure measurement and DC current measurement, and (4) pressure measurement and DC voltage measurement. The transmitter input pressure and transmitter output can be measured simultaneously.

Averaging

The CA700 can take a moving average of the measured values and display the results. If averaging is on, relative display (RELATIVE) and max/min display (MIN/MAX) use averaged values.

Scaling

By assigning scale values to the upper and lower limits of the span, you can linearly scale measured values and display the scaled results. If scaling is enabled, you can assign an appropriate unit.

Alarm

When a measured value exceeds the specified range, the value will blink, and an alarm mark will appear. If the relative display feature (RELATIVE) is enabled, the CA700 uses the measured values, not the relative values, to make this decision. This feature is not available for leak rate measurement.

Percentage Display

By taking the lower limit of the specified span to be 0% and the upper limit to be 100%, the CA700 displays the measured values as percentages along with the measured values themselves.

Relative Display (RELATIVE)

The CA700 displays the difference between the measured values and the specified reference value (measured value – reference value). You can set the reference value to any value that you choose or the value that exists when you press RELATIVE.

Hold

The CA700 holds the measurement display.

Min/Max Display

The CA700 can display the minimum and maximum measured values.

Hysteresis Warning (HYS)

If the external pressure sensor in use receives the pressure exceeding its limit value, this may affect measurement for a while even when the pressure falls below the limit value.

In the CA700, if the pressure input to the external pressure sensor exceeds the limit value, "HYS" appears on the screen.

Even when the pressure falls below the limit value, HYS continues to appear for a period of time. This period depends on the range and input pressure. Wait for HYS to disappear, and then use the external pressure sensor.

DC Current and DC Voltage Source

The CA700 can generate DC current between 0 to 20 mA and DC voltage between 0 to 5 V. It can generate a specific DC current or voltage or sweep the current or voltage within a specific range.

Sweeping

There are two sweep modes: step and linear.

Step sweep

The CA700 divides the specified range of current or voltage into 2 to 10 equal levels and outputs them.

Linear sweep

The CA700 varies the current or voltage output linearly within the specified range.

Simulation

The CA700 can absorb a specified amount of current from a distributor or other external voltage source through the high terminal. This enables you to use the CA700 as a two-wire transmitter simulator for loop and other tests.

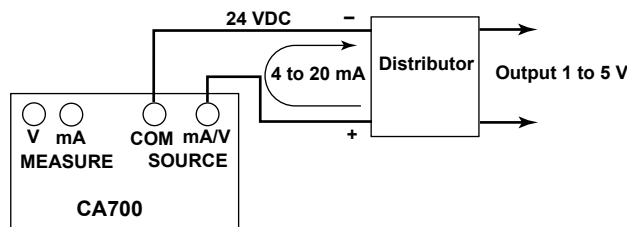

DC Current and DC Voltage Measurement

The available DC current measurement ranges are 20 mA and 100 mA, and the available DC voltage measurement ranges are 5 V and 50 V.

Like pressure measurement, the following features are also available.

- Averaging
- Scaling
- Alarm
- Percentage display
- Relative display
- Hold
- Min/Max display

mA Loop

The CA700 can measure the current that flows when a 24 VDC constant voltage is applied. This can be used in transmitter loop tests.

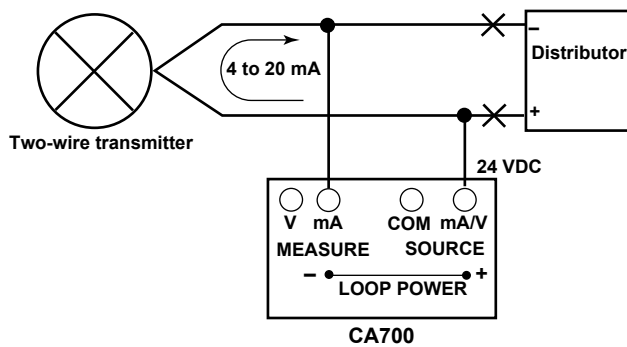

1.3 Calibration Feature

The calibration feature is useful for calibrating and adjusting pressure transmitters and pressure switches.

Transmitter Calibration

The CA700 can generate (source) an input signal to a pressure transmitter and measure the output from the transmitter. If the transmitter input is pressure, you can use a pressure pump to apply the pressure to the transmitter and monitor the pressure from the pressure pump on the CA700.

The following source and measurement combinations are available.

Measure	Source
Pressure (P)	Current (mA)
Pressure (EXT P)	mA loop (mA LOOP)
	Voltage (V)
Current (mA)	Pressure (P) ¹
mA Loop (mA LOOP)	Pressure (EXT P) ¹
Voltage (V)	

¹ The CA700 cannot generate pressure. It monitors the input to the calibration target.

Calibration Procedure

You can save up to twenty calibration procedures.

You can set the pressure unit, averaging, scaling, calibration range (0 and 100%), tolerance (%), the number of calibration points, and the calibration point slope.

Averaging and Scaling

Averaging and scaling are the same as with normal measurement.

Calibration Range

Set the boundaries (0% and 100%) of the range to calibrate in relation to the transmitter input and output.

The CA700 divides the calibration range by the number of calibration points to determine the reference value of the transmitter input and output at each calibration point.

Tolerance

The tolerance is the difference between the transmitter output and the reference value that is determined from the calibration range and the number of calibration points at each calibration point. The CA700 indicates pass or fail depending on whether the transmitter output is within the tolerance.

Number of Calibration Points

This is the number of calibration points within the calibration range. This number and the calibration range determine the calibration points. If this number is set to 1, calibration will be performed at 0% or 100% (0% if the calibration point slope is up or up/down; 100% if it is down).

Calibration Point Slope

You can set whether to calibrate from 0% to 100% or from 100% to 0% or from 0% to 100% to 0% in a round-trip fashion. When calibrating in a round-trip fashion, the number of calibration points is (the specified number of calibration points × 2 – 1).

Saving Calibration Data

You can save calibration data to a file. If you adjust a transmitter, the data before and after the adjustment can be saved to files with the following file names.

File Name

The name of the file for data before adjustment is MSxxF_y.CSV where

- MS: Fixed (measurement/source file)
- xx: Calibration group number (00 to 99)
- F: Fixed (data before adjustment)
- y: File number (0 to 9)

The name of the file for data after adjustment is MSxxL_y.CSV where

- MS: Fixed (measurement/source file)
- xx: Calibration group number (00 to 99)
- L: Fixed (data after adjustment)
- y: File number (0 to 9)

The calibration group number remains the same as long as the calibration target information or calibration procedure remain unchanged. Therefore, the calibration data files of the same transmitter before and after adjustment will have the same calibration group number.

Saved Information

The following information is saved in a calibration data file.

- Instrument information
- Calibration procedure information
- Calibration date
- CA700 serial number
- Calibration result

Pressure Switch Calibration

In the calibration procedure in “Transmitter Calibration,” if you select pressure switch (P SWITCH, EXT SWITCH) for measurement, you can calibrate pressure switches.

The CA700 measures the pressure required for the switch to open and close, the difference between the open and close pressures, and the resistance when the switch is closed.

The CA700 can calibrate mechanical pressure switches. It cannot be used to calibrate open-collector-contact, voltage-output, or current-output pressure switches.

Saving Calibration Data

Like transmitter calibration, the calibration results can be saved.

File Name

The name of the file for data before adjustment is SWxxF_y.CSV where

- SW: Fixed (pressure switch test data file)
- xx: Calibration group number (00 to 99)
- F: Fixed (data before adjustment)
- y: File number (0 to 9)

The name of the file for data after adjustment is SWxxL_y.CSV where

- SW: Fixed (pressure switch test data file)
- xx: Calibration group number (00 to 99)
- L: Fixed (data after adjustment)
- y: File number (0 to 9)

Saved Information

The following information is saved in a calibration data file.

- Instrument information
- Calibration procedure information
- Calibration date
- CA700 serial number
- Calibration result

The following types of data are saved as calibration results.

- Pressure when the pressure switch opened
- Pressure when the pressure switch closed
- Difference between the pressure when the pressure switch opened and that when the pressure switch is closed
- Resistance when the pressure switch closed

1.4 Saving Data

Pressure, current, and voltage measurement data, leak rate measurement data, and transmitter or pressure switch calibration data can be saved to CSV files.

Saving Pressure, Current, and Voltage Measurement Data

There are two ways to save measured values.

Save

Measured values are appended to a file each time you press the Save function key. The file name is SAVEXX.CSV where

SAVE: A common name given to files saved with the save function

XX: Sequence number (00 to 99)

Data is added to the same file until any of the following conditions is met.

- When a setting is changed
- When the voltage measurement range is changed
- When the number of save data points exceeds 2000
- When the power is turned off

Logging

The specified number of data points are saved at a preset sampling interval. The file name is LOGXX.CSV. A file is created each time logging ends.

LOG: A common name given to files saved with the logging function

XX: Sequence number (00 to 99)

For Leak Rate Measurement

For leak rate measurement, measured data is added to the file each time a leak test finishes. The file name is LEAKXX.CSV where

LEAK: A common name given to files saved with the leak function

XX: Sequence number (00 to 99)

Data is added to the same file until any of the following conditions is met.

- When a setting is changed
- When you exit from a leak test
- When the power is turned off

Pressure Transmitter and Pressure Switch Calibration Data

Calibration data before and after transmitter adjustment is saved to files with identifiable names.

Calibration data is added to the files every time a calibration is performed at the calibration points.

The file names are as follows:

Calibration data file before adjustment: MSxxF_y.CSV, SWxxF_y.CSV

Calibration data file after adjustment: MSxxL_y.CSV, SWxxL_y.CSV

MS: Fixed (measurement/source file)

SW: Fixed (pressure switch test data file)

xx: Calibration group number (00 to 99)

F: Fixed (data before adjustment)

L: Fixed (data after adjustment)

y: File number (0 to 9)

The calibration group number remains the same as long as the calibration target information or calibration procedure remain unchanged. Therefore, the calibration data files of the same transmitter before and after adjustment will have the same calibration group number.

Copying and Deleting Data

You can copy data in the CA700 to a USB storage device.

You can also delete data in the CA700.

1.5 Communication Feature

You can connect the CA700 to a PC through the USB port.

Depending on the USB settings, you can remotely control the CA700 from a PC or use the CA700 as a USB device on the PC.

Remote Control

You can use dedicated communication commands to remotely control the CA700 from a PC.

The following operations can be controlled remotely.

- CA700 configuration (limited features)
- CA700 configuration retrieval (limited features)
- Measured data retrieval
- CA700 calibration execution

USB Storage

You can use the CA700 as USB storage device from a PC.

From a PC, you can access the CA700 internal memory and read the data.

1.6 USB Feature

Host Feature

You can connect a USB storage device to the CA700 and copy the measured data in the CA700 to the USB storage device.

Only USB memory devices can be connected as USB storage devices. Hard disks and other media cannot be used.

PC Connection Feature

You can connect the CA700 to a PC and use the CA700 as a USB storage device on the PC or use dedicated commands to remotely control the CA700 from the PC.

When the CA700 is being used as a USB storage device on the PC, measured data cannot be saved on the CA700.

1.7 Other Features

Backlight On/Off

To reduce battery consumption, you can turn off the LCD backlight.

Auto Power-off

When the auto power-off feature is enabled, the CA700 automatically turns off if there is no user interaction for about 60 minutes. Auto power-off is automatically disabled (the icon also disappears) while the CA700 is logging or performing min/max measurement.

Hold Feature

The hold feature holds the screen. While the screen is held, you can only use the HOLD, backlight, and power on/off keys and the Save/Logging function key.

Min/max measurement and alarm features continue even while the screen is held.

If you save data with the save feature while the screen is held, the held data (the data displayed on the screen) is saved.

LCD Contrast

You can set the LCD contrast to any of the four available levels. Change the contrast depending on the environment that you are using the CA700 in.

Decimal Point Display

You can set the decimal point to a period or comma.

CSV Data Separator

You can set the CSV data separator to comma, semicolon, or tab.

Language

You can set the language displayed on the screen to English, Japanese, Chinese, or Korean.

Firmware Upgrade

You can upgrade the firmware versions of the internal and external pressure sensors of the CA700.

2.1 Measuring Pressure

Procedure

WARNING

To prevent injury to the user and damage to devices caused by incorrect connection or pressure leakage, be sure to connect tubing correctly to the CA700 pressure input port by following the instructions in the Getting Started Guide, IM CA700-02EN.

Selecting the Item under Measurement

- From the top menu, use the ▲ or ▼ key to select **Measure and Source**, and press **ENTER**.
The source/measure screen appears.

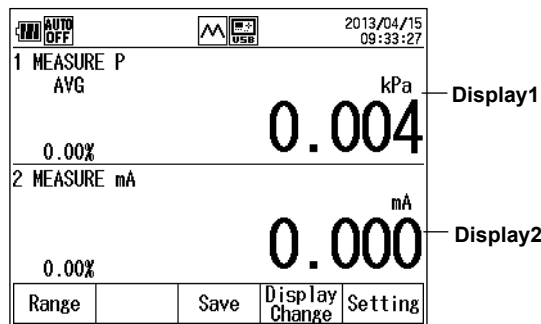

- Press **Setting (F5)**.
Display1 Setting and Display2 Setting appear on the function menu.

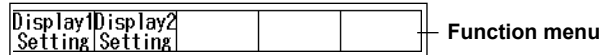

- Press **Display1 Setting (F1)**.
The pressure measurement setting screen appears.

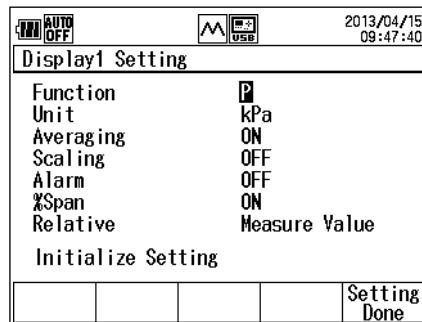

Note

- To confirm the settings, be sure to press **Setting Done (F5)**.
- When settings are changed, data will not be available for about 1.8 seconds, and the display will show "----." During this period, the response to an OD command will be "----E+3" or something similar. For details, see the explanation of the OD command in section 5.4.

- Use the ▲ or ▼ key to select **Function**, and press **ENTER**.
The measurement function options are displayed.

2.1 Measuring Pressure

- Use the ▲ or ▼ key to select **P** or **EXT P**, and press **ENTER**.

Function: P

2013/04/15 09:47:40		
Display1 Setting		
Function	P	— Sets the unit
Unit	kPa	— Turns averaging on and off
Averaging	ON	— Turn scaling on and off and set scaling.
Scaling	OFF	— Turn the alarm on and off and set the alarm.
Alarm	OFF	— Turns the percentage display on and off
%Span	ON	— Sets the relative display based on the reference value
Relative	Measure Value	— Initializes the settings
Initialize Setting		— Confirms the settings
Setting Done		

Function: EXT P

2017/02/16 12:05:55		
Display1 Setting		
Function	EXT P	— Sets the measurement range
Range	16MPa	— Sets the unit
Unit	MPa	— Turns averaging on and off
Averaging	OFF	— Turn scaling on and off and set scaling.
Scaling	OFF	— Turn the alarm on and off and set the alarm.
Alarm	OFF	— Turns the percentage display on and off
%Span	ON	— Sets the relative display based on the reference value
Relative	Measure Value	— Initializes the settings
Initialize Setting		— Confirms the settings
Setting Done		

Setting Measurement Conditions

If necessary, set the measurement conditions.

Setting the Measurement Range (when Function is set to EXT P)

- Use the ▲ or ▼ key to select **Range**, and press **ENTER**.
The measurement range options are displayed on the function menu
- Use the function key to select the measurement range.

Setting the Unit

- Use the ▲ or ▼ key to select **Unit**, and press **ENTER**.
The unit options are displayed.
- Use the ▲ or ▼ key to select a unit, and press **ENTER**.

Setting Averaging

- Press the ▲ or ▼ key to select **Averaging**.
ON and OFF appear on the function menu.
- Press **ON (F1)** or **OFF (F2)**.

Setting the Scaling

12. Press the ▲ or ▼ key to select **Scaling**.
ON and OFF appear on the function menu.
13. Press **ON (F1)** or **OFF (F2)**.
14. If you select ON, simply press **ENTER**.
The scaling setting screen appears.

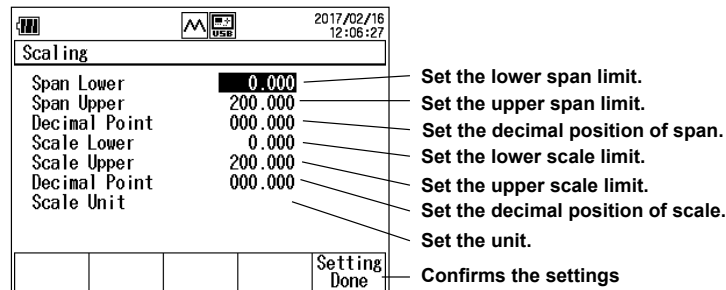

15. Use the ▲ or ▼ key to select **Span Lower**, and press **ENTER**.
16. Press the ◀ or ▶ key to move to the digit you want to change, press the ▲ or ▼ key to set the number.
To confirm the value, press **ENTER**.
Likewise, set Span Upper, Scale Lower, and Scale Upper.
Span Upper must be set to a value greater than Span Lower.
Scale Upper must be set to a value greater than Scale Lower.
17. Use the ▲ or ▼ key to select **Decimal Point**, and press **ENTER**.
The options of the span decimal point position are displayed.
18. Use the ▲ or ▼ key to select a value, and press **ENTER**.

Note

The span decimal point position becomes the decimal point positions of Alarm and %Span.

19. Repeat the operations similar to steps 16 through 18 to set the values of Scale Lower, Scale Upper, and Decimal Point.
20. Use the ▲ or ▼ key to select **Scale Unit**, and press **ENTER**.
A character input screen appears.
21. Use the ▲, ▼, ◀, and ▶ keys to select a character, and then press **ENTER**. The character will be entered.
After entering all the characters, press **DONE (F5)**.
22. After setting the scaling parameters, press **Setting Done (F5)**.
To discard all of the scaling settings, press the **ESC** key.
The system returns to the Display1 Setting display.

Note

The settings are not yet confirmed. To confirm the settings, press **Setting Done (F5)** again on the Display1 Setting display.

Setting the Alarm

- 23. Press the ▲ or ▼ key to select **Alarm**.
ON and OFF appear on the function menu.
- 24. Press **ON (F1)** or **OFF (F2)**.
- 25. If you select ON, press **ENTER**.
The alarm setting screen appears.

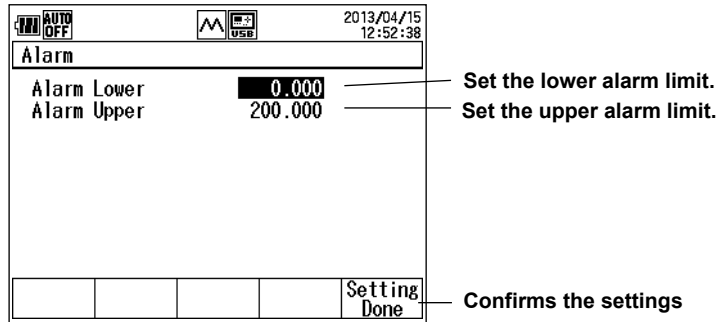

- 26. Use the ▲ or ▼ key to select **Alarm Lower**, and press **ENTER**.
- 27. Press the ◀ or ▶ key to move to the digit you want to change, press the ▲ or ▼ key to set the number.
To confirm the value, press **ENTER**.
Likewise, set Alarm Upper.

Note

The decimal point position is the same as the span decimal point position in Scaling.

- 28. After entering the values, press **Setting Done (F5)**.
To discard all of the alarm settings, press the **ESC** key.
The system returns to the Display1 Setting display.

Note

The settings are not yet confirmed. To confirm the settings, press **Setting Done (F5)** on the Display1 Setting display.

Setting the Percentage Display

- 29. Press the ▲ or ▼ key to select **%Span**.
ON and OFF appear on the function menu.
- 30. Press **ON (F1)** or **OFF (F2)**.
- 31. If you select ON, press **ENTER**.
The percentage display setting screen appears.

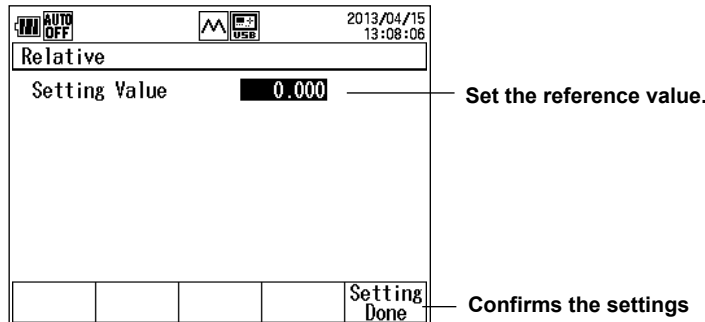

- 32. Use the ▲ or ▼ key to select **Span Lower**, and press **ENTER**.

33. Press the ◀ or ▶ key to move to the digit you want to change, press the ▲ or ▼ key to set the number.

To confirm the value, press **ENTER**.

Likewise, set Span Upper.

Note

The decimal point position is the same as the span decimal point position in Scaling.

34. After entering the values, press **Setting Done (F5)**.

To discard all of the % Span settings, press the **ESC** key.

The system returns to the Display1 Setting display.

Note

The settings are not yet confirmed. To confirm the settings, press **Setting Done (F5)** on the Display1 Setting display.

Setting the Reference Value and Relative Display

35. Press the ▲ or ▼ key to select **Relative**.

Measure Value and Setting Value appear on the function menu.

36. Press **Measure Value (F1)** or **Setting Value (F2)**.

If you select Measure Value, the measured value when you press RELATIVE will become the reference value.

37. If you select Setting Value, press **ENTER**.

The reference value setting screen appears.

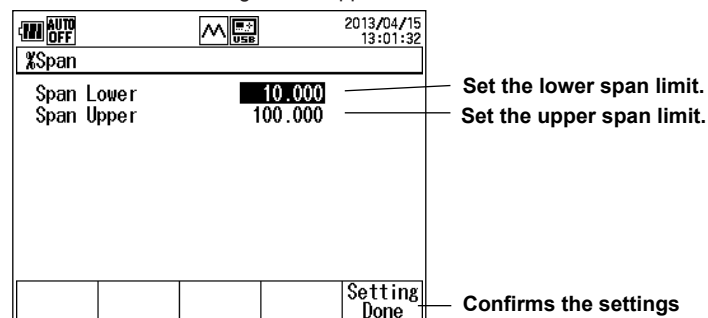

38. Press the ◀ or ▶ key to move to the digit you want to change, press the ▲ or ▼ key to set the number.

To confirm the value, press **ENTER**.

39. After entering the values, press **Setting Done (F5)**.

To discard all of the relative settings, press the **ESC** key.

The system returns to the Display1 Setting display.

Note

The settings are not yet confirmed. To confirm the settings, press **Setting Done (F5)** on the Display1 Setting display.

Initializing the Settings

37. Use the ▲ or ▼ key to select **Initialize Setting**, and press **ENTER**.

The pressure measurement settings are initialized.

Finishing the Settings

38. After entering the measurement conditions, press **Setting Done (F5)**.

The screen shown in step 1 appears.

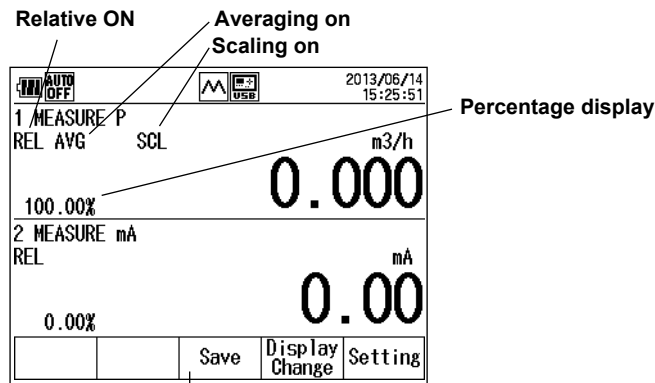

Saves measured data

Saving Measured Data

39. Press **Save (F3)** or **Logging Start (F3)**. The measured data is saved.

What appears at F3 varies depending on the data save method.

Note

For details on setting the data save method (Save or Logging), see section 4.1.

Explanation

Measurement Function (Function)

To measure pressure, select one of the following:

P: Input pressure directly to the CA700 to measure pressure.

The following pressure ranges can be measured depending on models:

- CA700-*-01 (200 kPa model): -80 to 200 kPa (gauge pressure)
- CA700-*-02 (1000 kPa model): -80 to 1000 kPa (gauge pressure)
- CA700-*-03 (3500 kPa model): -80 to 3500 kPa (gauge pressure)

EXT P: Use the external pressure sensor to measure pressure.

In addition to pressure (P, EXT P), the following is available.

P LEAK/EXT LEAK: Leak rate (see section 2.2)

DC current and DC voltage can be measured or generated simultaneously while pressure is being measured (Display2 setting). For details on DC current and DC voltage source and measurement, see section 2.3 or 2.4.

Measurement Range (for EXT P)

Select the measurement range of the external pressure sensor.

- PM100-*-05(16 MPa): 7 MPa, 10 MPa, 16 MPa
- PM100-*-06(70 MPa): 25 MPa, 50 MPa, 70 MPa

Unit

You can set the pressure unit to mbar, bar, Pa, hPa, kPa, MPa, or atm.

Averaging

The CA700 can take a moving average of the measured values.

Relative and min/max values are calculated using averaged values.

When averaging is set to ON, "AVG" is displayed on the screen.

Scaling

By assigning scale values to the pressure at the lower span limit and the pressure at the upper span limit, you can view measured values converted in any physical quantity.

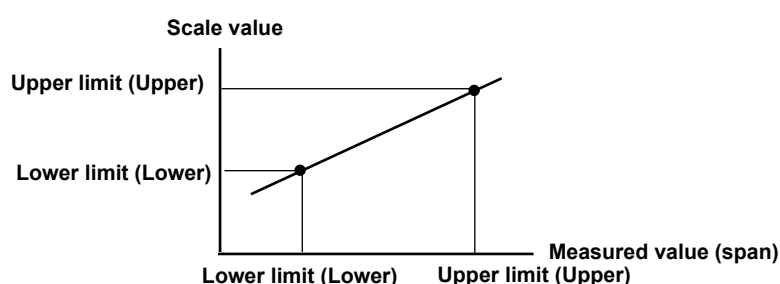

When scaling is set to ON, "SCL" is displayed on the screen.

Alarm

When a measured value exceeds the specified range, an alarm mark will appear, and the value will blink. If you change the scaling settings while the alarm is set to ON, the alarm is automatically turned off, and the upper and lower alarm limits are initialized.

Percentage Display

By taking the specified span to be 100%, the CA700 displays current values as percentages.

Reference Value and Relative Display

The CA700 displays the difference relative to the specified value.

Measure Value: The measured value when you press RELATIVE will become the reference value.

Setting Value: The reference value is set to any value of your choosing in the range of -999999 and 999999.

You can turn relative display on and off using a panel key.

Initializing the Settings

All settings except Function are initialized.

Averaging, Scaling and Alarm are set to OFF; Averaging and %Span are set to ON; Relative is set to Measure Value.

Saving Measured Data

Measured data, including the measure and source values of Display2, are saved to a CSV file.

The following two save methods are available.

Save: Measured values are appended to a file each time you press the Save function key. Data is saved to the same file until any of the following conditions is met.

- When a setting is changed
- When the measuring range is changed
- When the number of save data points exceeds 2000
- When the power is turned off

The file name is SAVExx.CSV (xx: a sequence number between 00 and 99).

Logging: If you press the Logging Start function key, the CA700 will save data at the specified interval. The operation stops when you press the Logging Stop function key or when the specified number of data values are saved.

The file name is LOGxx.CSV (xx: a sequence number between 00 and 99).

You can set the measurement data save method using Data Save Setting under Device Setting from the top menu. For details, see section 4.1.

2.2 Measuring Leak Rates

Procedure

WARNING

To prevent injury to the user and damage to devices caused by incorrect connection or pressure leakage, be sure to connect tubing correctly to the CA700 pressure input port by following the instructions in the Getting Started Guide, IM CA700-02EN.

Selecting the Measurement Function

- From the top menu, use the ▲ or ▼ key to select **Measure and Source**, and press **ENTER**.
The source/measure screen appears.

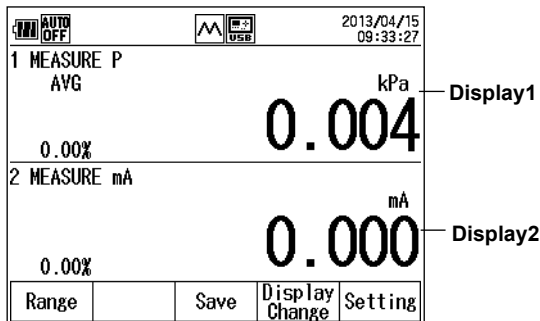

- Press **Setting (F5)**.
Display1 Setting and Display2 Setting appear on the function menu.

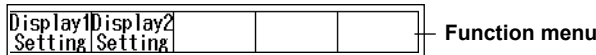

- Press **Display1 Setting (F1)**.
The pressure measurement setting screen appears.

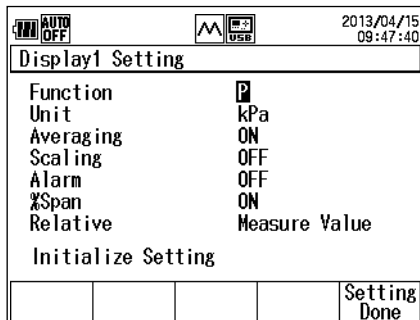

- Use the ▲ or ▼ key to select **Function**, and press **ENTER**.
The measurement function options are displayed.

5. Use the ▲ or ▼ key to select **P LEAK** or **EXT LEAK**(external pressure sensor), and press **ENTER**.

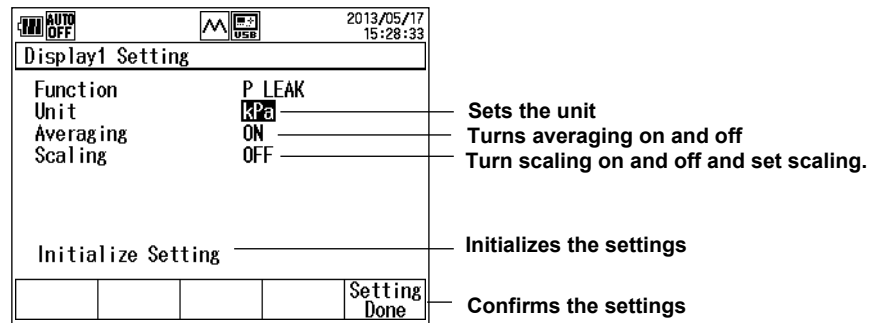

Setting Measurement Conditions

If necessary, set the measurement conditions.

The procedure for setting the range(EXT PEAK), unit, averaging, and scaling and for initializing the settings are the same as in pressure measurement. See section 2.1.

Finishing the Settings

6. After entering the measurement conditions, press **Setting Done (F5)**.
The leak rate measurement screen appears.

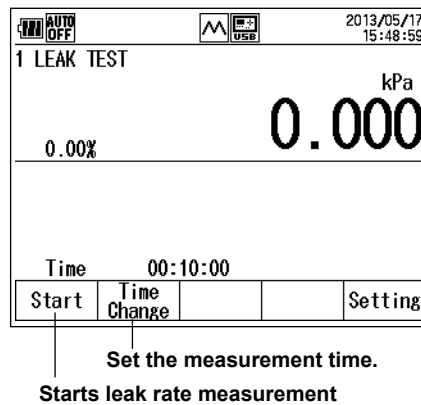

Setting the Measurement Time

7. Press **Time Change (F2)**.
The measurement time edit screen appears.
8. Press **ENTER**. You can now edit the measurement time.
9. Press the ◀ or ▶ key to move to the digit you want to change, press the ▲ or ▼ key to set the number.
To confirm the value, press **ENTER**.
10. Press **Setting Done(F5)**.
The settings are confirmed.

Starting a Measurement and Saving Data

11. Press **Start (F1)**. The leak rate measurement starts, and the F1 function key changes to “Quit.”
When the specified measurement time elapses or if you press Quit (F1), leak rate measurement stops, and the measured data is saved.

Explanation

Measurement Function

The CA700 measures the following items and displays the result.

- Pressure at the start of measurement
- Pressure at the end of measurement
- Difference between the pressure at the start of measurement and the pressure at the end of measurement (measurement start pressure – measurement end pressure).
- Leak rate ((measurement start pressure – measurement end pressure)/minutes)
- Measurement time

Unit, Averaging, and Scaling

Unit, averaging, and scaling are the same as with pressure measurement. See section 2.1.

Saving Measured Data

The CA700 saves the following measured data to a CSV file.

- Pressure and date/time at the start of measurement
- Pressure and date/time at the end of measurement
- Pressure difference (measurement start pressure – measurement end pressure)
- Leak rate

The file name is LEAKxx.CSV (xx: a sequence number between 00 and 99).

2.3 Generating DC Current and DC Voltage

Procedure

Refer to the Getting Started Guide (IM CA700-02EN), and correctly connect the CA700 to the current or voltage supply device.

DC current and DC voltage source is valid when the pressure measurement of Display1 is set to normal pressure measurement (P or EXT P). Follow the procedure in section 2.1 to set the measurement pressure to normal pressure (P or EXT P).

- From the top menu, use the ▲ or ▼ key to select **Measure and Source**, and press **ENTER**.
The source/measure screen appears.

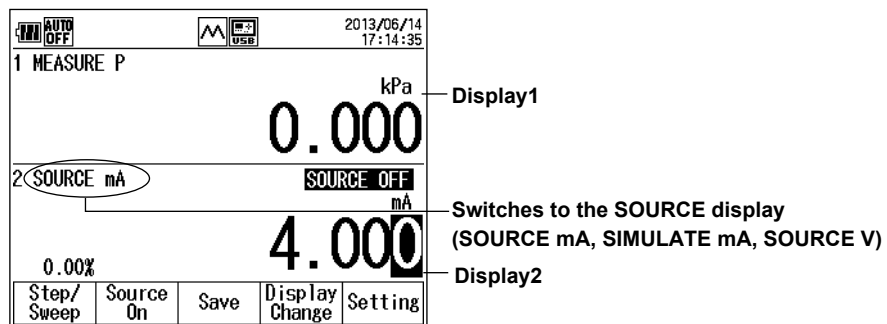

- When Display2 is showing the measure screen, press **SOURCE/MEASURE** to switch Display2 to SOURCE.
- Press **Setting (F5)**.
Setting categories appear on the function menu.

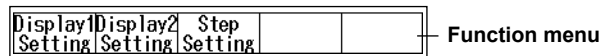

- Press **Display2 Setting (F2)**.
The source function setting screen appears.

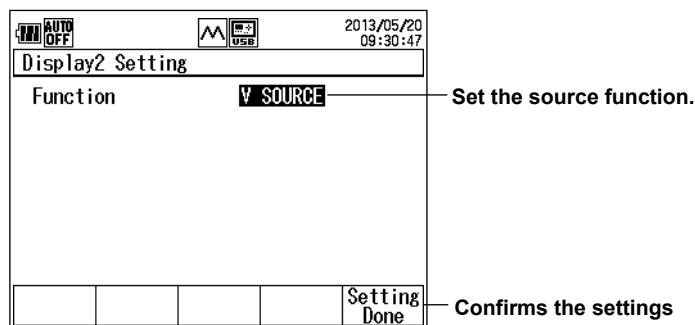

- Press **ENTER**.
The measurement item options are displayed.
- Use the ▲ or ▼ key to select the source function, and press **ENTER**.
- Press **Setting Done(F5)**.
The screen shown in step 1 appears.

Generating the Specified DC Current and DC Voltage

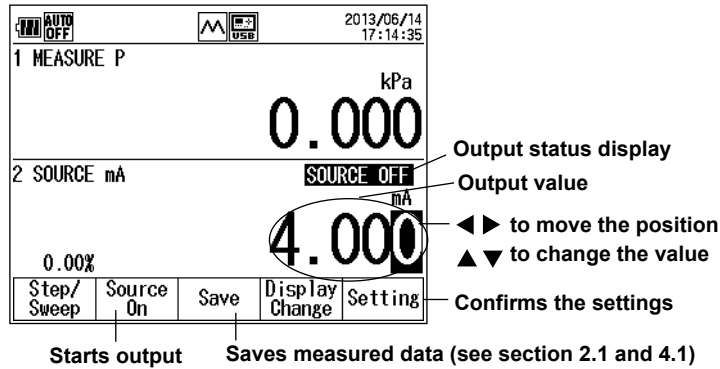

8. Press the ◀ or ▶ key to move to the digit you want to change, press the ▲ or ▼ key to set the number.
9. Press **Source On (F2)**.
The F2 key changes to “Source Off,” the output status display changes to SOURCE ON, and the CA700 generates the specified DC current or DC voltage.

Saving Data

10. Press **Save (F3)** or **Logging Start (F3)**. The source value is saved along with the pressure measurement data.
What appears at F3 varies depending on the data save method.

Note

For details on setting the data save method (Save or Logging), see section 4.1.

Sweeping the Source Value

Setting the Source Method

8. After step 7, press **Setting (F5)**.
Setting categories appear on the function menu.

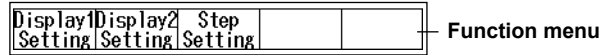

9. Press **Step Setting (F3)**.
The source method setting screen appears.

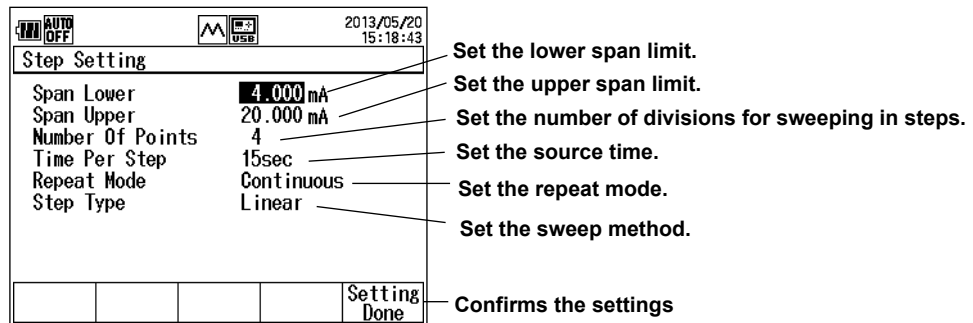

Setting the Span

Set the source current or voltage range.

10. Use the ▲ or ▼ key to select **Span Lower**, and press ENTER.
11. Press the ◀ or ▶ key to move to the digit you want to change, press the ▲ or ▼ key to set the number.
To confirm the value, press **ENTER**.
Likewise, set Span Upper.

Setting the Number of Divisions

12. Use the ▲ or ▼ key to select **Number Of Points**, and press ENTER.
13. Press the ◀ or ▶ key to move to the digit you want to change, press the ▲ or ▼ key to set the number.
To confirm the value, press **ENTER**. The CA700 divides the range between the lower and upper span range by the specified number, and generates source signals at the divided levels.

Setting the Source Time

14. Press the ▲ or ▼ key to select **Time Per Step**.
Source time options appear on the function menu.
15. Press a key from **15sec (F1)** to **60sec (F4)**.

Setting the Repeat Mode

16. Press the ▲ or ▼ key to select **Repeat Mode**.
Repeat modes appear on the function menu.
17. Press **Single Shot (F1)** or **Cont.(F2)**.

2.3 Generating DC Current and DC Voltage

Setting the Source Value Sweep Method

18. Press the ▲ or ▼ key to select **Step Type**.

Sweep methods appear on the function menu.

19. Press **Linear (F1)** or **Step (F2)**.

Confirming the Settings

20. After entering the measurement conditions, press **Setting Done (F5)**.

The screen shown in step 1 appears.

Sweeping Automatically

21. After step 19, press **Step/Sweep (F1)**.

Sweep	Source On	Span 100%	Step Up	Step Down
-------	-----------	-----------	---------	-----------

22. Press **Sweep (F1)**.

Source On		Logging Start	Display Change	
-----------	--	---------------	----------------	--

23. Press **Source On (F1)**.

The F1 key changes to “Source Off,” the output status display changes to SOURCE ON, and the CA700 sweeps the source values according to the sweep method settings.

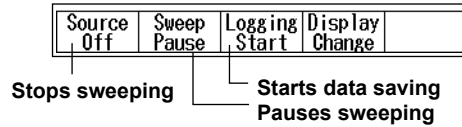

Pausing and Resuming Sweeping

24. The F2 key displays Sweep Pause. To pause sweeping, press **Sweep Pause (F2)**.

The F2 key changes to Sweep Start, and the output value is held. The CA700 continues to generate current or voltage.

To resume sweeping, press **Sweep Start (F2)**. The CA700 will continue sweeping from where it paused.

Saving Data

25. Press **Save (F3)** or **Logging Start (F3)**. The source value is saved along with the pressure measurement data.

What appears at F3 varies depending on the data save method.

Note

For details on setting the data save method (Save or Logging), see section 4.1.

Sweeping (Stepping) Manually

21. After step 20, press **Step/Sweep (F1)**.

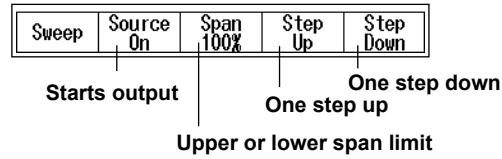

22. Press **Span 100% (F3)** or **Span 0% (F3)** to set the output value to the upper or lower span limit. Press **Step Up (F4)** or **Step Down (F5)** to change the output by the step value specified in the output method.

You can also set a specific output value by using the ◀, ▶, ▲, and ▼ keys.

23. Press **Source On (F2)**.

The F2 key changes to Source Off, the output status display changes to SOURCE ON, and the CA700 generates the specified DC current or DC voltage.

You can step up or down the output value while the CA700 is generating output by following step 22.

Saving Data

24. While the CA700 is generating output, press **ESC**.

The previous screen returns.

Step/Sweep	Source On	Logging Start	Display Change	Setting
------------	-----------	---------------	----------------	---------

25. Press **Save (F3)** or **Logging Start (F3)**. The source value is saved along with the pressure measurement data.

What appears at F3 varies depending on the data save method.

Note

For details on setting the data save method (Save or Logging), see section 4.1.

Explanation

Source Function

You can select from the following three source functions.

- mA Source
- mA Simulate
- V Source

mA Source

The CA700 output DC current in the range of 0 to 20 mA.

mA Simulate

The CA700 can absorb a specified amount of current from a distributor or other external voltage source. This enables you to use the CA700 as a two-wire transmitter simulator for loop and other tests.

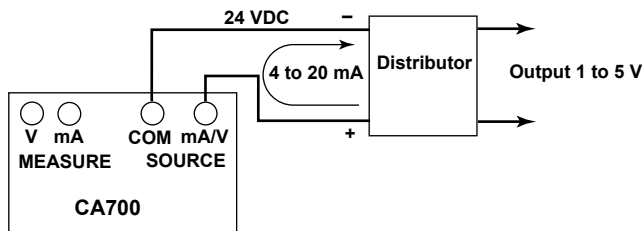

CAUTION

- Use a distributor or other external source voltage in the range of 5 to 28 V.
 - If the HART resistor inside the CA700 is turned on, use the external voltage source in the range of 12 to 28 V.
 - Do not reverse the applied voltage polarity. Doing so may damage the CA700.
-

V Source

The CA700 output DC voltage in the range of 0 to 5 V.

Sweeping

The CA700 can vary the source value in the range defined by the lower and upper span limits. You can vary the source value stepwise or linearly.

Step (Step)

The CA700 varies the source value in steps from the lower to the upper span limit.

Linear (Linear)

The CA700 varies the source value linearly from the lower to the upper span limit.

Span (Span Lower, Span Upper)

You can set the source range. The source range is defined by the 0% (Lower) and 100% (Upper) values that you specify.

Number of Divisions (Number Of Points)

When sweeping in steps, set the number of divisions between the lower and upper span limits.

Source Time (Time Per Step)

When sweeping in steps, set the duration of each step. When sweeping linearly, set the duration for the source value to change from 0% to 100%.

Sweeping in Steps

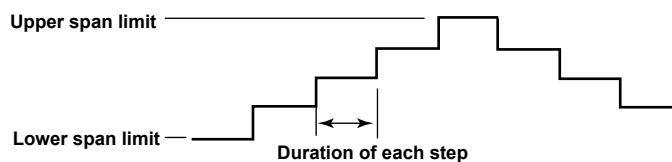

Sweeping Linearly

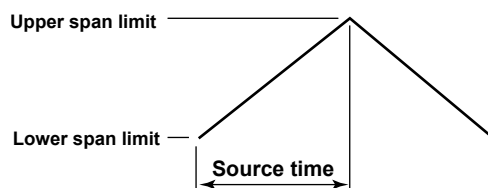

Repeat Mode (Repeat Mode)

There are two repeat modes: Single Shot and Cont (Continuous).

Single Shot: The source changes from 0% to 100% to 0% and stops.

Cont: The source repeats the sweeping from 0% to 100% to 0%.

Saving Data

You can save the source value along with the pressure measurement data.

For details, see sections 4.1 and 2.1.

2.4 Measuring DC Current and DC Voltage

Procedure

Refer to the Getting Started Guide (IM CA700-02EN), and correctly connect the CA700 to the device under measurement.

DC current and DC voltage measurement is valid when the pressure measurement of Display1 is set to normal pressure measurement (P). Follow the procedure in section 2.1 to set Function to normal pressure (P).

1. From the top menu, use the ▲ or ▼ key to select **Measure and Source**, and press **ENTER**.
The source/measure screen appears.

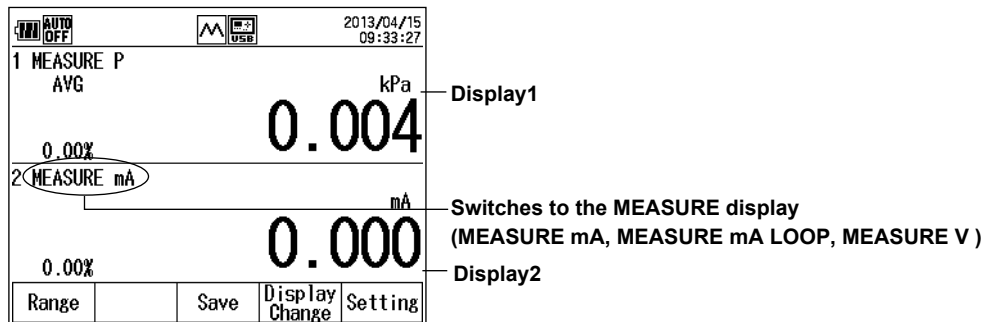

2. When Display2 is showing the source screen, press **SOURCE/MEASURE** to switch Display2 to MEASURE.
3. Press **Setting (F5)**.
The setting categories are displayed.



4. Press **Display2 Setting (F2)**.
The measurement function setting screen appears.

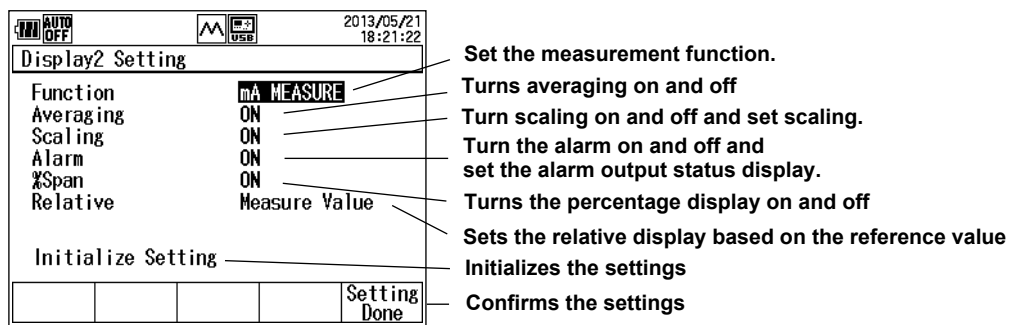

Setting Measurement Functions

5. Use the ▲ or ▼ key to select **Function**, and press **ENTER**.
The measurement function options are displayed.
6. Use the ▲ or ▼ key to select the measurement function, and press **ENTER**.

Setting Measurement Conditions

If necessary, set the measurement conditions.

The procedure for setting averaging, scaling, alarm, percentage display, and relative display items and for initializing the settings are the same as in pressure measurement. See section 2.1.

Finishing the Settings

- After entering the measurement conditions, press **Setting Done (F5)**.
The screen shown in step 1 appears.

mA MEASURE or V MEASURE		mA LOOP	
2013/06/17 10:05:53 1 MEASURE P AVG kPa 0.002 2 MEASURE mA mA 0.00 0.00% Range Save Display Change Setting		2013/06/17 10:06:07 1 MEASURE P AVG kPa 0.002 2 MEASURE mA LOOP LOOP POWER OFF mA 0.000 - 25.00% Loop On Save Display Change Setting	

Note

When settings are changed, data will not be available for about 300 milliseconds, and the display will show "----." During this period, the response to an OD command will be "----E-3." For details, see the explanation of the OD command in section 5.4.

Changing the Measurement Range (for mA MEASURE and V MEASURE)

- Press **Range (F1)**. The range changes every time you press the key.

Applying Loop Voltage (for mA LOOP)

- After step 7, press **Loop On (F2)**.
The F2 key changes to Loop Off, the output status display changes to LOOP POWER ON, and 24 VDC is applied across the measurement terminals.

Saving Measured Data

- Press **Save (F3)** or **Logging Start (F3)**. The measured data is saved.
What appears at F3 varies depending on the data save method.

Note

For details on setting the data save method (Save or Logging), see section 4.1.

Explanation

Measurement Function (Function)

There are three measurement functions: mA MEASURE, mA LOOP, and V MEASURE.

mA MEASURE: The CA700 can measure DC current in the range of -20 mA to +20 mA or -100 mA to +100 mA.

mA LOOP: The CA700 measures current while applying 24 VDC across the measurement terminals.

DC current in the range of 0 mA to +20 mA can be measured.

This can be used in transmitter loop tests.

V MEASURE: The CA700 can measure DC voltage in the range of -5 to 5 V or -50 to 50 V.

Averaging

The CA700 can take a moving average of the measured values.

Relative and min/max values are calculated using averaged values.

When averaging is set to ON, "AVG" is displayed on the screen.

Scaling, Alarm, Percentage Display, and Relative Display

These items are the same as with pressure measurement. See section 2.1.

Measurement Range (for mA MEASURE and V MEASURE)

mA MEASURE: You can switch between 20 mA range and 100 mA range. Select the appropriate range for the measured values.

20mA: -20.000 mA to +20.000 mA

100mA: -100.00 mA to +100.00 mA

V MEASURE: You can switch between 5V range and 50V range. Select the appropriate range for the measured values.

5V: -5.0000V to +5.0000V

50V: -50.000V to +50.000V

Loop Voltage (for mA LOOP)

You can turn on and off the loop voltage applied across the measurement terminals.

The MEASURE mA terminal is negative, and the SOURCE mA/V terminal is positive.

When you turn on the loop voltage, 24 VDC is applied across the MEASURE mA terminal and the SOURCE mA/V terminal.

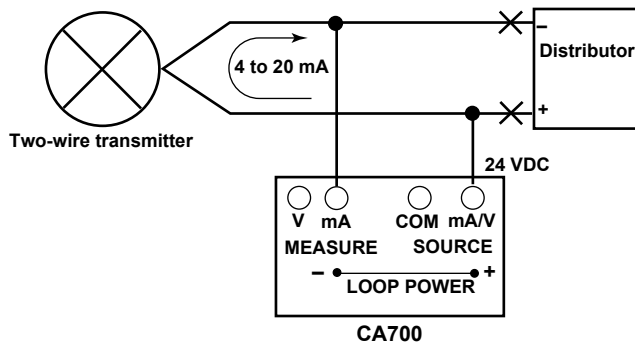

Saving Data

You can save the current and voltage values along with the pressure measurement data.

For details, see sections 4.1 and 2.1.

3.1 Connecting to a Pressure Transmitter or Pressure Switch



WARNING

- Do not apply pressure exceeding the allowable input range. Excessive pressure may cause injury or damage to the instrument.

Model		CA700-*-01	CA700-*-02	CA700-*-03
Allowable input	Negative pressure	2.7 kPa abs	2.7 kPa abs	2.7 kPa abs
	Positive pressure	500 kPa	3000 kPa	4500 kPa



CAUTION

- When joining the connector, using a spanner only on the connector side may break the inside of the instrument. Be sure to use another spanner on the cut-out of the input port to tighten the connector.

French



AVERTISSEMENT

- Ne pas appliquer de pression supérieure à la plage d'entrée autorisée. Une pression excessive risquerait de provoquer des blessures ou d'endommager l'instrument.

Modèle		CA700-*-01	CA700-*-02	CA700-*-03
Entrée autorisée	Pression négative	2,7 kPa abs	2,7 kPa abs	2,7 kPa abs
	Pression positive	500 kPa	3000 kPa	4500 kPa



ATTENTION

L'utilisation d'une clé uniquement sur le côté connecteur lors du raccordement du connecteur risque de casser l'intérieur de l'instrument. Pour serrer le connecteur, veiller à utiliser une autre clé sur la découpe du port d'entrée.

Connecting a Pressure Transmitter to the CA700

Connect the pressure pump output to the transmitter input and the CA700 input through branching.

To use the external pressure sensor, connect the pressure pump output to the pressure transmitter input and the external pressure sensor input through branching, and connect the sensor output to the external pressure sensor connection terminal of the CA700.

Some pressure pumps have two output ports: one for applying pressure and another for the pressure meter.

Connect the electrical signal from the pressure transmitter to the signal terminal of the CA700. Connect to the appropriate input terminals on the CA700 depending on the type of output received from the pressure transmitter.

3.1 Connecting to a Pressure Transmitter or Pressure Switch

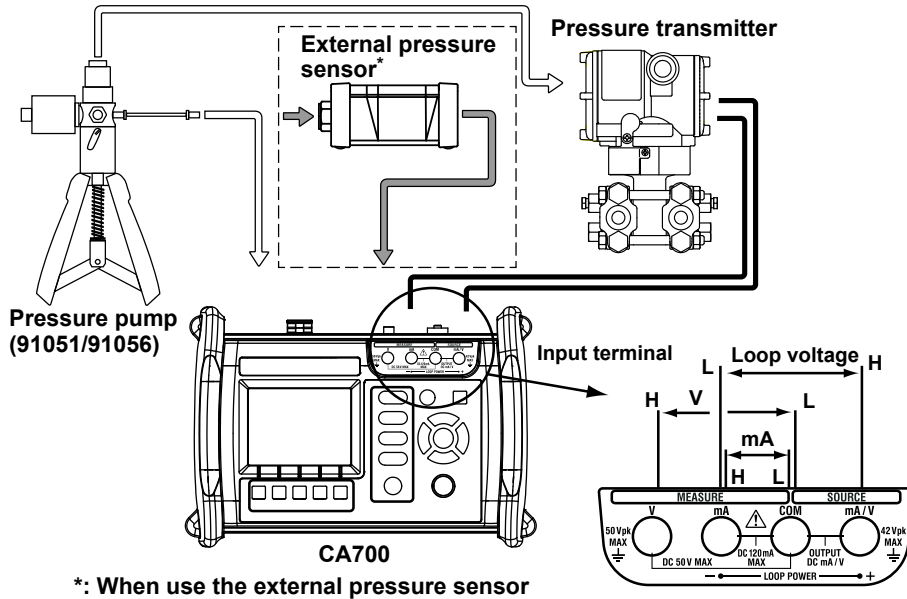

Connecting a Pressure Switch to the CA700

Connect the pressure pump output to the pressure switch input and the CA700 input through branching.

To use the external pressure sensor, connect the pressure pump output to the pressure switch input and the external pressure sensor input through branching, and connect the sensor output to the external pressure sensor connection terminal of the CA700.

Some pressure pumps have two output ports: one for applying pressure and another for the pressure meter.

Connect the contact terminal of the pressure switch to the signal terminal of the CA700.

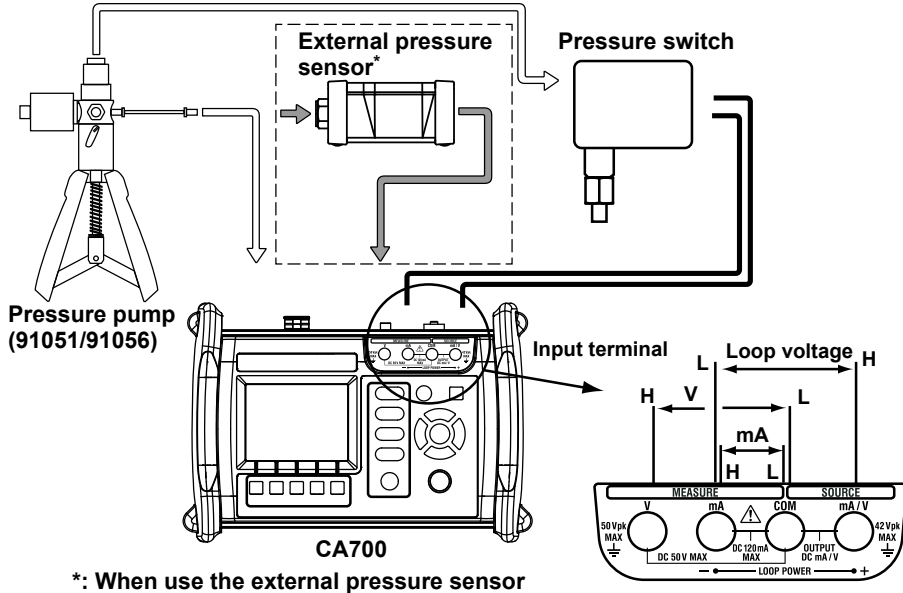

The CA700 can calibrate mechanical pressure switches. It cannot be used to calibrate open-collector contact, voltage output, or current output pressure switches.

3.2 Select the Calibration Procedure

Procedure

- From the top menu, use the ▲ or ▼ key to select **Calibrate**, and press **ENTER**.
The calibration display appears.

Calibrate		No. 3		
Model No.	EJA110J-003			
Serial No.	789			
Tag No.	TEST-003			
Test Strategy				
Source	mA			
Measure	P			
Procedure	5Up/Down			
Edit	Select Proc.	As Found	Adjust	As Left

Information about the selected calibration procedure (source function, measurement function, number of calibration points, and calibration direction)

- Press **Select Proc.(F2)**.

A list of registered calibration procedures is displayed.

Up to 20 sets of procedures can be registered. They are displayed in four windows.

Calibrate		No. 2		
Model No.	EJA110J-002			
Serial No.	ABC			
1. TEST-001	,EJA110J-001			
2. TEST-002	,EJA110J-002			
3. TEST-003	,EJA110J-003			
4. TEST-004	,EJA110J-004			
5. TEST-005	,EJA110J-005			

- Press ◀ or ▶ to change the page and ▲ or ▼ to select the calibration procedure you want to edit. Press **ENTER**.

Information of the selected calibration procedure is displayed.

Calibrate		No. 1		
Model No.	EJA110J-001			
Serial No.	12345			
Tag No.	TEST-001			
Test Strategy				
Source	P			
Measure	mA LOOP			
Procedure	5Up/Down			
Edit	Select Proc.	As Found	Adjust	As Left

Explanation

Calibration Procedure

You can register up to twenty sets of calibration processes. A calibration procedure consists of a set of device information, measurement function and source function.

To calibrate a pressure device, select one of the registered procedures to perform calibration.

3.3 Setting the Device Information and the Calibration Conditions of the Pressure Transmitter

Procedure

1. In the calibration display, press **Edit (F1)**.

The calibration procedure setup screen appears. The setup screen is divided into three pages: Transmitter Information, Measure, and Source.

Hold down ▲ or ▼ to change the screen.

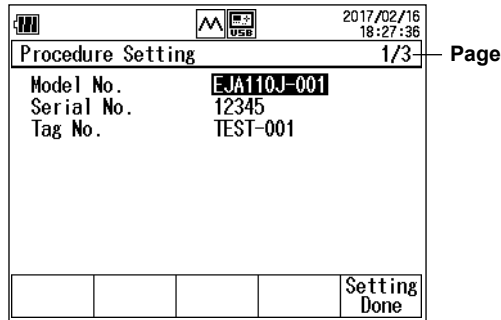

Setting the Device Information.

Entering the Model Number (Model No.)

2. Use the ▲ or ▼ key to select **Model No.**, and press **ENTER**.

A character input screen appears.

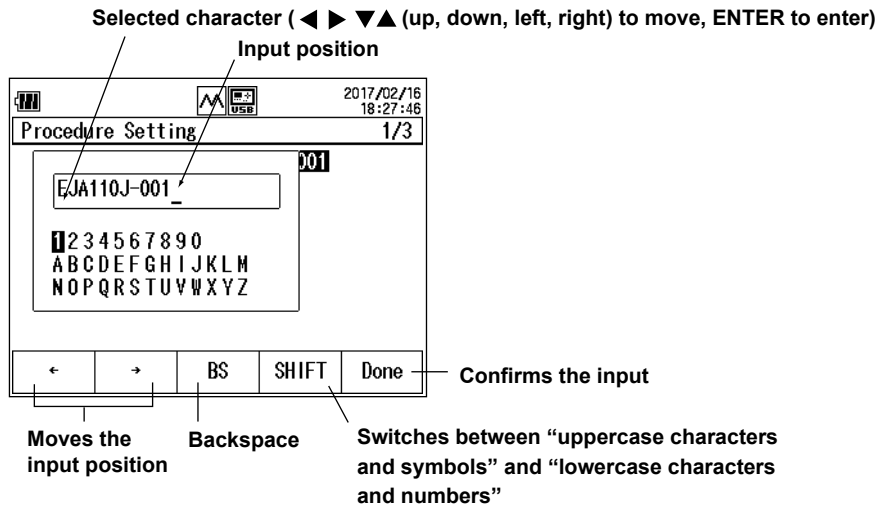

3. Press ← (F1) or → (F2) to move the input position, press <, >, ▲, or ▼ to select a character, and press **ENTER** to enter the selected character.

4. After entering the characters, press **Done (F5)**.

To discard the settings, press the **ESC** key.

Entering the Tag No. and Serial No.

5. Use the ▲ or ▼ key to select **Tag No.** or **Serial No.**, and press **ENTER**.

6. Like the model number, enter the tag number and serial number.

Setting Measurement Conditions

7. Hold down the ▼ key.

The display switches to page 2/3 (measurement condition setting display).

When the measurement function is set to mA MEASURE, mA LOOP, or V MEASURE

2017/02/16 18:44:43	
Procedure Setting - Measure 2/3	
Function	mA LOOP
Averaging	OFF
Scaling	OFF
0% Value	5.000
100% Value	20.000
Tolerance	0.51 %
Setting Done	

Set the measurement function.
 Turns averaging on and off
 Turn scaling on and off and set scaling.
 Set the 0% value.
 Set the 100% value.
 Tolerance for pass/fail judgment
 Confirms the settings

When the measurement function is set to P (for details on P SWITCH, see section 3.6)

2017/02/16 18:44:57	
Procedure Setting - Measure 2/3	
Function	P
Unit	kPa
Averaging	ON
Scaling	OFF
0% Value	0.000
100% Value	200.000
Tolerance	0.51 %
Setting Done	

Set the measurement function.
 Set the unit.
 Turns averaging on and off
 Turn scaling on and off and set scaling.
 Set the 0% value.
 Set the 100% value.
 Tolerance for pass/fail judgment
 Confirms the settings

When the measurement function is set to EXT P (for details on EXT SWITCH, see section 3.6)

2017/02/16 18:45:10	
Procedure Setting - Measure 2/3	
Function	EXT P
Sensor Type	16MPa
Range	16MPa
Unit	kPa
Averaging	ON
Scaling	OFF
0% Value	0.0
100% Value	16000.0
Tolerance	0.51 %
Setting Done	

Set the measurement function.
 Set the sensor type.
 Set the measurement range.
 Set the unit.
 Turns averaging on and off
 Turn scaling on and off and set scaling.
 Set the 0% value.
 Set the 100% value.
 Tolerance for pass/fail judgment
 Confirms the settings

Setting Measurement Functions

8. Set the calibration target output.

Use the ▲ or ▼ key to select **Function**, and press **ENTER**.

The measurement function options are displayed.

9. Use the ▲ or ▼ key to select the measurement function, and press **ENTER**.

If you set the measurement function to pressure (P or EXT P), the source function (SOURCE) is set to mA SOURCE, mA SIMULATE, or V SOURCE.

If you set the measurement function to mA MEASURE, mA LOOP, or V MEASURE, the source function (monitor only) is set to pressure (P or EXT P).

If the measurement function is set to pressure switch (P SWITCH or EXT SWITCH), you cannot set the source function.

Setting Sensor Type and Range (for external pressure sensor)

10. Use the ▲ or ▼ key to select **Sensor Type**, and press **ENTER**.

11. Press the ▲ or ▼ key to select the sensor type, and press **ENTER**

The procedure for setting Range is the same as in pressure measurement. See section 2.1.

Setting Unit (for Pressure), Averaging, and Scaling

These items are the same as with pressure measurement. See section 2.1.

Setting the 0% Value and 100% Value

12. Use the ▲ or ▼ key to select **0% Value**, and press **ENTER**.

13. Press the ◀ or ▶ key to move to the digit you want to change, press the ▲ or ▼ key to set the number.

To confirm the value, press **ENTER**.

Likewise, set the 100% value.

Setting the Tolerance for Pass/Fail Judgment

14. Use the ▲ or ▼ key to select **Tolerance**, and press **ENTER**.

15. Press the ◀ or ▶ key to move to the digit you want to change, press the ▲ or ▼ key to set the number.

To confirm the value, press **ENTER**.

The values assigned to 0% and 100% will be used as references.

Setting Source Conditions

16. Hold down the ▼ key.

The display switches to page 3/3 (or 3/4 when the source function is set to EXT P, source condition setting display).

When the source function is set to P

2017/02/17 08:37:16	
Procedure Setting - Source(Monitor)3/3	
Function	P
Unit	kPa
Averaging	ON
Scaling	OFF
0% Value	0.000
100% Value	200.000
Number Of Points	5
Direction	Up/Down
Setting Done	

Set the source function.
 Set the unit.
 Turns averaging on and off
 Turn scaling on and off and set scaling.
 Set the 0% value.
 Set the 100% value.
 Set the number of calibration points.
 Set whether to calibration from 0% or 100%.
 Confirms the settings

When the source function is set to mA SOURCE, mA SIMULATE, or V MEASURE

2017/02/17 08:37:39	
Procedure Setting - Source(Monitor)3/3	
Function	mA SOURCE
0% Value	4.000
100% Value	20.000
Number Of Points	5
Direction	Up/Down
Setting Done	

Set the source function.
 Set the 0% value.
 Set the 100% value.
 Set the number of calibration points.
 Set whether to calibration from 0% or 100%.
 Confirms the settings

When the source function is set to EXT P

The first screenshot shows the 'Procedure Setting - Source(Monitor)3/4' menu. The settings are: Function: EXT P, Sensor Type: 16MPa, Range: 16MPa, Unit: kPa, Averaging: ON, Scaling: OFF, 0% Value: 0.0, and 100% Value: 16000.0. A 'Setting Done' button is at the bottom right. A blue double-headed arrow and up/down arrow icons are between the two screenshots.

The second screenshot shows the 'Procedure Setting - Source(Monitor)4/4' menu. The settings are: Number Of Points: 5 and Direction: Up/Down.

Annotations for the first screenshot:

- Set the source function.
- Set the sensor type.
- Set the measurement range.
- Set the unit.
- Turns averaging on and off
- Turn scaling on and off and set scaling.
- Set the 0% value.
- Set the 100% value.
- Confirms the settings

Annotations for the second screenshot:

- Set the number of calibration points.
- Set whether to calibration from 0% or 100%.

Setting the Source Function

17. Set the input to the calibration target.

Use the ▲ or ▼ key to select **Function**, and press **ENTER**.

The source function options are displayed.

18. Use the ▲ or ▼ key to select the source function, and press **ENTER**.

In step 9, if you set the measurement function to pressure (P or EXT P), set the source function (SOURCE) to mA SOURCE, mA SIMULATE, or V SOURCE.

In step 4, if you set the measurement function to mA MEASURE, mA LOOP, or V MEASURE, set the source function (monitor only) to pressure (P or EXT P).

Note

- If you specify a source function that does not correspond to the measurement function, the measurement function setting is automatically changed.
- In step 4, if the measurement function is set to pressure switch (P SWITCH or EXT SWITCH), you cannot set the source function.
- Even if you set the source function to pressure, the CA700 will not produce pressure. It will only display the input pressure value.

Setting Sensor Type and Range (for external pressure sensor)

19. Use the ▲ or ▼ key to select **Sensor Type**, and press **ENTER**.

20. Press the ▲ or ▼ key to select the sensor type, and press **ENTER**

The procedure for setting Range is the same as in pressure measurement. See section 2.1.

Setting Unit, Averaging, and Scaling (Pressure)

These items are the same as with pressure measurement. See section 2.1.

Setting the 0% Value and 100% Value

21. Set values that correspond to 0% and 100% of the measured values you set in steps 5 and 6.

Use the ▲ or ▼ key to select **0% Value**, and press **ENTER**.

22. Press the ◀ or ▶ key to move to the digit you want to change, press the ▲ or ▼ key to set the number.

To confirm the value, press **ENTER**.

Likewise, set the 100% value.

Setting the Number of Calibration Points (Number Of Points)

23. Use the ▲ or ▼ key to select **Number Of Points**, and press **ENTER**.

24. Press the ◀ or ▶ key to move to the digit you want to change, press the ▲ or ▼ key to set the number.

To confirm the value, press **ENTER**.

The range is 1 to 10.

Setting the Calibration Direction (Direction)

25. Press the ▲ or ▼ key to select **Direction**.

The options appear on the function menu.

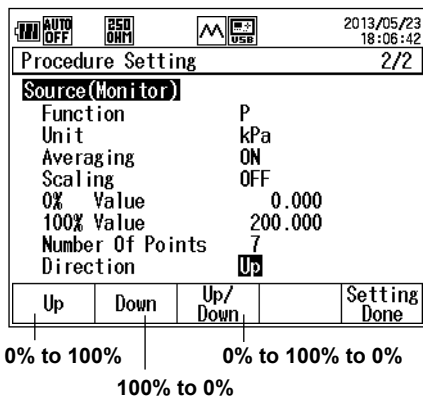

26. Press **Up (F1)**, **Down (F2)**, or **Up/Down (F3)**.

Confirming the Settings

27. After entering the information, press **Setting Done (F5)**. The settings are confirmed.

Press **ESC** to return the display.

Explanation**Device Information**

The device information that you set here is saved to a file along with the calibration data. This is convenient in associating the saved data with the device.

Input Characters

The number of characters that you can enter is as follows.

Model No.: Up to 20 alphanumeric characters

Tag No.: Up to 32 alphanumeric characters

Serial No.: Up to 15 alphanumeric characters

Measurement Function and Source Function

The measurement function measures the output from the calibration target, and the source function outputs the input to the calibration target. If you set the source function to pressure, the CA700 only monitors the input to the calibration target.

The combinations of the measurement function and source function are as follows.

Measurement Function	Source Function
Pressure (P)	DC current (mA SOURCE)
Pressure (EXT P, External pressure sensor)	Simulation (mA SIMULATE)
	DC voltage (V SOURCE)
Pressure switch (P SWITCH)	—
Pressure switch (EXT SWITCH, External pressure sensor)	
DC current (mA MEASURE)	Pressure (P)
Loop current (mA LOOP)	Pressure (EXT P, External pressure sensor)
DC voltage (V MEASURE)	

External pressure sensor type (EXT P or EXT SWITCH)

Set the sensor type according to the type of external pressure sensor to be used.

External Pressure Sensor	Sensor Type
PM100-*-05(16 MPa)	16MPa
PM100-*-06 (70 MPa)	70MPa

Measurement Range (EXT P or EXT SWITCH)

You can select the measurement range of the external pressure sensor.

When the Sensor Type is 16 MPa: 7 MPa, 10 MPa, 16 MPa

When the Sensor Type is 70 MPa: 25 MPa, 50 MPa, 70 MPa

Unit (Pressure)

You can select the pressure unit.

Averaging

The CA700 displays moving average results.

Scaling

The CA700 displays linearly scaled results. You can assign a unit appropriate for the values after scaling.

The scaling method is the same as pressure measurement. See section 2.1.

0% Value and 100% Value

Set the 0% and 100% of the calibration range in terms of the calibration target input and output (which corresponds to the input).

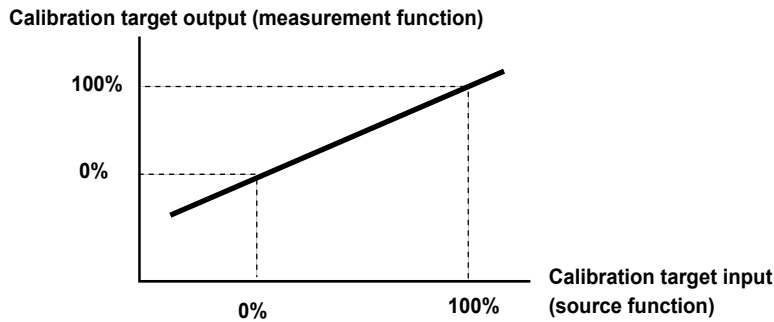

Tolerance for Pass/Fail Judgment

Set the tolerance for making pass/fail judgments on calibration results. The tolerance is set in reference to the 0% and 100% values described above.

Tolerance = $\pm((100\% \text{ value of the measurement function} - 0\% \text{ value of the measurement function}) \times \text{tolerance setting}/100)$

For example, when the calibration target output is 4 mA to 20 mA and this range is assigned to 0 to 100%, if the tolerance range is set to 0.02%, the tolerance is given by $\pm(20 \text{ mA} - 4 \text{ mA}) \times 0.02/100 = \pm 0.0032 \text{ mA}$.

Number of Calibration Points (Number Of Points)

Set the number of measurement points between 0% to 100%.

The range is 1 to 10. If you specify 1, the calibration is performed at 0% if the calibration direction (Direction) is set to Up or Up/Down and 100% if set to Down. If you specify a number between 2 and 10, the calibration is performed for the number of specified points. This includes calibration at 0% and 100%.

The calibration points are at equally divided points between 0% and 100%. For example, if the number of calibration points is set to 5, the calibration points are 0%, 25%, 50%, 75%, and 100%.

Calibration Direction (Direction)

Set whether to start calibrating from 0% (Up), from 100% (Down), or from 0% to 100% back down to 0% (Up/Down).

- Up: 0% to 100%
- Down: 100% to 0%
- Up/Down: 0% to 100% to 0%

If the calibration direction is Up/Down, the number of calibration points is given by

Number of calibration points = (Number Of Points setting) $\times 2 - 1$.

For example, if the number of calibration points is set to 5, the calibration points are 0%, 25%, 50%, 75%, 100%, 75%, 50%, 25%, and 0% (total of 9 points).

3.4 Calibrating the Pressure Transmitter

Procedure

This section mainly describes the procedure for when Measure is set to mA Loop and Source is set to pressure (P).

Selecting the Calibration Procedure

1. In the calibration display, press **Select Proc. (F2)**.

The calibration procedure setting display appears.

Calibrate		No. 2	
Model No.	EJA110J-002		
Serial No.	ABC		
1. TEST-001	,EJA110J-001		
2. TEST-002	,EJA110J-002		
3. TEST-003	,EJA110J-003		
4. TEST-004	,EJA110J-004		
5. TEST-005	,EJA110J-005		

2. Use the ◀, ▶, ▲, or ▼ key to select a calibration procedure, and press **ENTER**.

The calibration procedure is selected, and the calibration display returns.

Calibrate		No. 1		
Model No.	EJA110J-001			
Serial No.	12345			
Tag No.	TEST-001			
Test Strategy				
Source	P			
Measure	mA LOOP			
Procedure	5Up/Down			
Edit	Select Proc.	As Found	Adjust	As Left

The calibration procedure information switches to the selected one.

Saving the Data before Adjustment

3. Press As Found (F3).

The display switches to the source and measure value display.

Loop On appears on the function menu.

If the source function is set to DC current or DC voltage, Source On appears on the function menu.

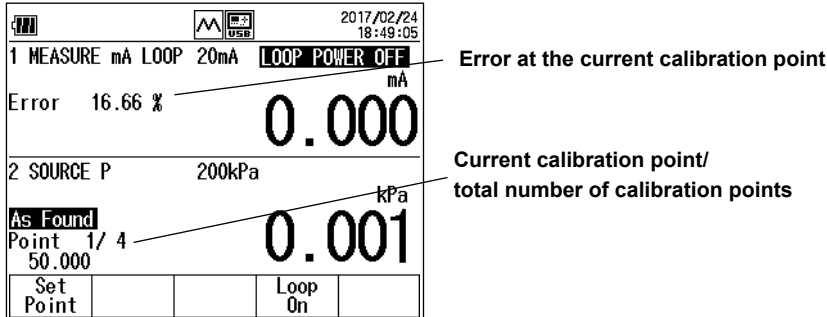

4. Press Loop On (F4). The CA700 outputs a 5 VDC loop voltage and measures the loop current. The F4 key changes to Loop Off.

If the source function is set to DC current or DC voltage, press **Source On (F4)**. The CA700 generates the 0% DC current or DC voltage. The F4 key changes to Source Off.

5. From the pressure pump, apply the pressure for the adjustment point. The pressure pump output is displayed on the CA700.

6. Press Set Point (F1). The pressure transmitter input value and output value are saved. The F2 key shows Next Point.

7. Press Next Point (F2). The CA700 proceeds to the next calibration point.

8. Repeat 4 to 7 for all the calibration points.

When you save the data for the last calibration data, the F5 key shows Done.

If you want to abort saving data, press ESC. The data up to that point will be discarded, and the operation will be aborted.

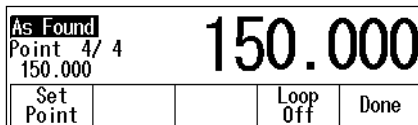

9. Press Done (F5).

The calibration data of all calibration points are saved to a single CSV file, and the calibration result is shown on the display.

Transmitter output		Error	
Transmitter input		(If a value falls outside the tolerance, the value appears highlighted.)	
Result		1/1	
Source kPa	Measure mA	Error %	
50.000	5.003	0.02	
83.333	10.006	0.04	
116.666	15.009	0.06	
150.000	20.012	0.08	
		Done	

10. Press Done (F5).

The calibration display returns.

Adjusting the Pressure Transmitter

11. In the calibration display, press **Adjust (F4)**.

A display for monitoring the pressure transmitter output appears.

Span 100%	Step Up	Step Down	Loop On	Adjust Done
--------------	------------	--------------	------------	----------------

Finishes adjustment

Outputs the loop power for the adjustment point
(current if the source function is set to current,
voltage if the source function is set to voltage)

Decreases the adjustment point

Increases the adjustment point

Adjust at 100% of span.

12. Press **Span100% (0%) (F1)**, **Step Up (F2)**, and **Step Down (F3)** to set the adjustment point. The adjustment points are the same as the calibration points.

13. From the pressure pump, apply the pressure for the adjustment point. The pressure pump output is displayed on the CA700.

14. Press **Loop On (F4)**. The CA700 supplies a 5 VDC loop voltage and measures the loop current. The F4 key changes to Loop Off.

If the source function is set to DC current or DC voltage, press **Source On (F4)**. The CA700 generates the 0% DC current or DC voltage. The F4 key changes to Source Off.

15. Adjust the pressure transmitter so that its output value displayed on the CA700 is within the tolerance.

16. Adjust the pressure transmitter at all calibration points. After making adjustments, press **Adjust Done (F5)** or **ESC**.

The calibration display returns.

Saving the Data after Adjustment

16. In the calibration display, press **As Left (F5)**.

The display switches to the source and measure value display.

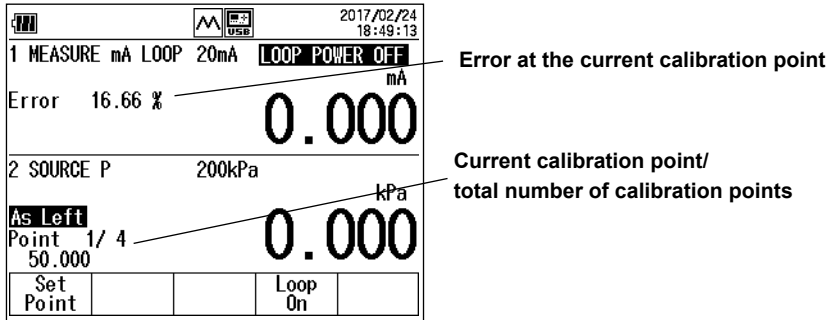

17. Using the same procedure as in “Saving the Data before Adjustment,” save the calibration data after adjustment.

18. When you finish saving the data of all calibration points, press **Done (F5)**.

The calibration data of all calibration points are saved to a single CSV file, and the calibration result is shown on the display.

19. Press **Done (F5)**.

The calibration display returns.

Explanation**Calibration Data File**

The pressure transmitter calibration data before and after adjustment is saved to CSV files.

File Name

Calibration data before adjustment: MSxxF_y.CSV

Calibration data after adjustment: MSxxL_y.CSV

xx: 00 to 99 (calibration group number)

Same number between the calibration data file before and after adjustment

y: 0 to 9, sequence number assigned to data files before adjustment and after adjustment

Because the number xx is the same for calibration data files before and after adjustment, the association is maintained.

If you change the device information or calibration procedure, the number xx is incremented.

Note

- If there are gaps in the calibration group numbers due to the deletion of files and the like, precedence is given to the missing numbers.
- If all the calibration group numbers or file sequence numbers are used up, an error will appear. Copy the necessary files to another location, and delete them.

Data That Is Saved

Calibration conditions, device information, date and time of calibration, pressure transmitter input (source) value at each calibration point, pressure transmitter output (measure) value, error (%), and judgment result are saved.

Judgment Result

If the pressure transmitter output value is within the tolerance set in section 3.3, PASS is displayed and saved. Otherwise, FAIL is saved.

3.5 Setting the Calibration Conditions of the Pressure Switch

Procedure

1. In the calibration display, press **Select Proc. (F2)**.

A list of registered calibration procedures is displayed.

Up to 20 sets of procedures can be registered. They are displayed in four windows.

2017/02/17 14:01:34	
Calibrate	No. 1
Model No.	EJA110J-001
Serial No.	12345
1. TEST-001	,EJA110J-001
2. TEST-002	,EJA110J-002
3. TEST-003	,EJA110J-003
4. TEST-004	,EJA110J-004
5.	

2. Press **◀** or **▶** to change the page and **▲** or **▼** to select the calibration procedure you want to edit. Press **ENTER**.

Information of the selected calibration procedure is displayed.

2017/02/17 14:02:20	
Calibrate	No. 5
Model No.	
Serial No.	
Tag No.	
Test Strategy	
Source	P
Measure	mA
Procedure	5Up/Down
Edit	Select Proc.
As Found	Adjust
As Left	

3. Press **Edit (F1)**.

The calibration procedure setting display appears.

2017/02/17 14:02:42	
Procedure Setting	1/3
Model No.	■
Serial No.	
Tag No.	
	Setting Done

Setting the Device Information

These items are the same as with pressure measurement. See section 3.3

Setting Measurement Conditions

Setting Measurement Functions

4. Set the calibration target output.
Use the ▲ or ▼ key to select **Function**, and press **ENTER**.
The measurement function options are displayed.
5. Use the ▲ or ▼ key to select **P SWITCH**, and press **ENTER**.

When the source function is set to P SWITCH

2017/02/17 14:03:43
Procedure Setting - Measure 2/2

Function	P SWITCH
Unit	kPa
Averaging	ON
Scaling	OFF

Setting Done

Callouts:
 - Set the Measurement function.
 - Set the unit.
 - Turns averaging on and off
 - Turn scaling on and off and set scaling.
 - Confirms the settings

When the source function is set to EXT SWITCH

2017/02/17 14:03:53
Procedure Setting - Measure 2/2

Function	EXT SWITCH
Sensor Type	16MPa
Range	16MPa
Unit	kPa
Averaging	ON
Scaling	OFF

Setting Done

Callouts:
 - Set the Measurement function.
 - Set the sensor type.
 - Set the measurement range.
 - Set the unit.
 - Turns averaging on and off
 - Turn scaling on and off and set scaling.
 - Confirms the settings

Setting Sensor Type and Range (for external pressure sensor)

The Sensor Type setting is the same as with the calibration conditions of the pressure transmitter. See section 3.3.

The Range setting is the same as with pressure measurement. See section 2.1.

Setting Unit, Averaging, and Scaling

These items are the same as with pressure measurement. See section 3.3.

Confirming the Settings

6. After entering the information, press **Setting Done (F5)**. The settings are confirmed.

Explanation

In pressure switch calibration, on the CA700, monitor the pressure applied to the pressure switch and measure the output switch resistance.

For the calibration conditions, set the pressure unit, averaging, and linear scaling for monitoring the pressure.

Sensor type is the same as with the calibration conditions of the pressure transmitter. See section 3.3.

Range, pressure unit, averaging, and linear scaling are the same as with pressure measurement. See section 2.1.

3.6 Calibrating a Pressure Switch

Procedure

Selecting the Calibration Procedure

1. In the calibration display, press **Select Proc. (F2)**.

The calibration procedure setting display appears.

2017/02/17 14:39:05	
Calibrate	No. 5
Model No.	SWITCH
Serial No.	12345
1. TEST-001	,EJA110J-001
2. TEST-002	,EJA110J-002
3. TEST-003	,EJA110J-003
4. TEST-004	,EJA110J-004
5. TEST-005	,SWITCH

2. Use the ◀ or ▶ key to change the page, and the ▲ or ▼ key to select a pressure switch (P SWITCH) calibration procedure, and press **ENTER**.

The calibration procedure is selected, and the calibration display returns.

2017/02/17 14:38:59				
Calibrate	No. 5			
Model No.	SWITCH			
Serial No.	12345			
Tag No.	TEST-0005			
Test Strategy				
Source				
Measure	P SWITCH			
Procedure				
Edit	Select Proc.	As Found	Adjust	As Left

Switches to the pressure switch calibration procedure information

Saving the Data before Adjustment

3. Press **As Found (F3)**.

A screen for monitoring the pressure applied to the pressure switch appears.

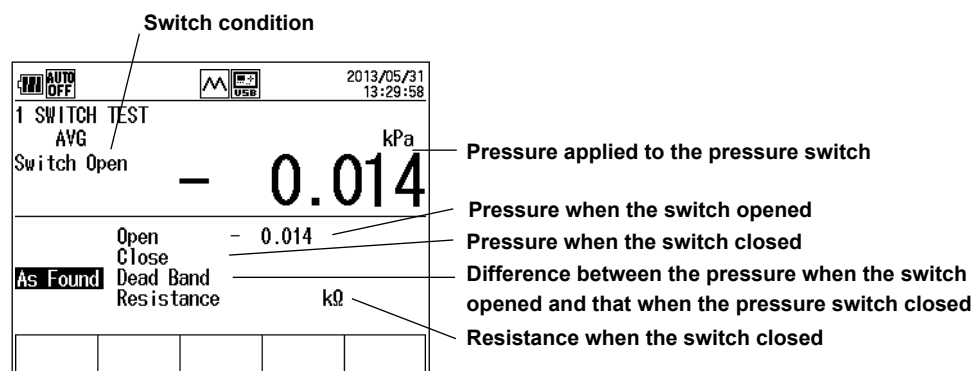

4. Slowly increase the pressure to the pressure switch until it opens. Then, slowly decrease the pressure switch until it closes.

When the pressure that opened the pressure switch, the pressure that closed the pressure switch, the difference between the two pressures, and the resistance when the pressure switch closed are measured, F5 changes to Done on the function menu.

The measured results are displayed.

5. Press **Done (F5)**. The data is saved to a file, and the calibration display of step 2 appears.

If you press ESC, the data is not saved, and the calibration display of step 2 appears.

Adjusting the Pressure Switch

6. In the calibration display, press **Adjust (F4)**.

A screen for monitoring the pressure applied to the pressure switch appears.

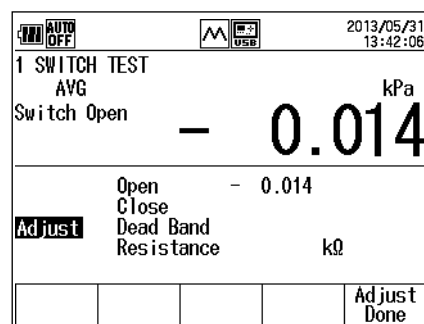

7. While monitoring the pressure applied to the pressure switch, adjust it.

8. Press **Adjust Done (F5)** or **ESC**.

The calibration display of step 2 appears.

Saving the Data after Adjustment

9. In the calibration display, press **As Left (F5)**.
A screen for monitoring the pressure applied to the pressure switch appears.
10. Using the same procedure as step 4 and 5, save the calibration data after adjustment.

Explanation

Calibration Data File

The pressure switch calibration data before and after adjustment is saved to CSV files.

File Name

Calibration data before adjustment: SWxxF_y.CSV

Calibration data after adjustment: SWxxL_y.CSV

xx: 00 to 99 (calibration group number)

Same number between the calibration data file before and after adjustment

y: 0 to 9, sequence number assigned to data files before adjustment and after adjustment

Because the number xx is the same for calibration data files before and after adjustment, the association is maintained.

If you change the device information or calibration procedure, the number xx is incremented.

Data That Is Saved

Calibration conditions, device information, date and time of calibration, the pressure that opened the pressure switch, the pressure that closed the pressure switch, the difference between the two pressures, and the resistance when the pressure switch closed are saved.

4.1 Setting How to Save Measured Data

This section describes the procedure for setting how to save the pressure, DC current, and DC voltage data that was measured in sections 2.1 and 2.4.

Procedure

1. From the top menu, use the ▲ or ▼ key to select **Device Setting**, and press **ENTER**.

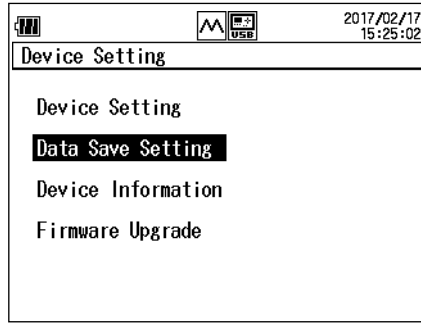

2. On the Device Setting screen, use the ▲ or ▼ key to select **Data Save Setting**, and press **ENTER**.

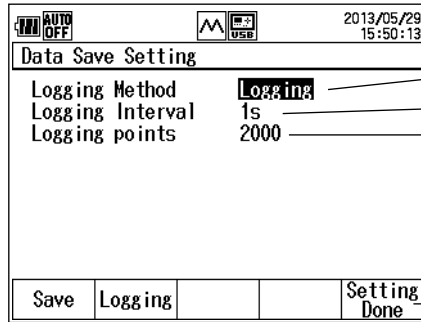

Set the save method.
 Set the data save interval (valid for Logging).
 Set the number of data values to save (valid for Logging).

Confirms the settings

Setting the Save Method

3. Press the ▲ or ▼ key to select **Logging Method**.
 Save and Logging appear on the function menu.

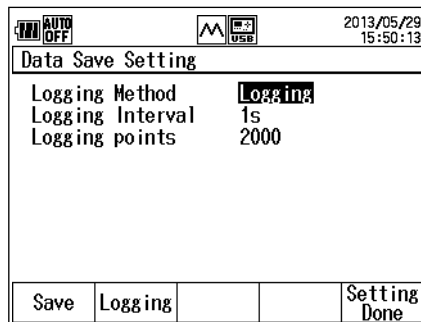

4. Press **Save (F1)** or **Logging (F2)**.
 If you select Save, the setting is complete. Proceed to step 9.

Setting the Data Save Interval (Valid for Logging)

- 5. Use the ▲ or ▼ key to select **Logging Interval**, and press **ENTER**.
The save interval options are displayed.

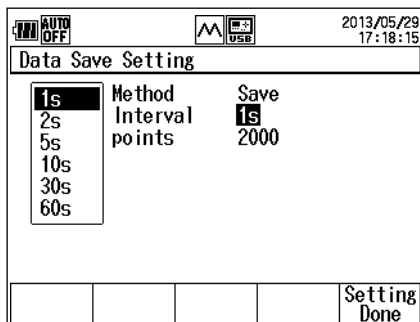

- 6. Use the ▲ or ▼ key to select a save interval, and press **ENTER**.

Set the number of data values to save (valid for Logging).

- 7. Use the ▲ or ▼ key to select **Logging Points**, and press **ENTER**.
- 8. Press the ◀ or ▶ key to move to the digit you want to change, press the ▲ or ▼ key to set the number.

To confirm the value, press **ENTER**.

Finishing the Settings

- 9. After entering the values, press **Setting Done (F5)**.
The screen shown in step 1 appears.

Explanation**Save Method**

The save method specifies how to save measured pressure, DC current, and DC voltage data.

Save: Measured values are appended to a file each time you press the Save function key. Data is saved to the same file until any of the following conditions is met.

- When a setting is changed
- When the measuring range is changed
- When the number of save data points exceeds 2000
- When the power is turned off

The file name is SAVExx.CSV (xx: a sequence number between 00 and 99).

Logging: If you press the Logging Start function key, the CA700 will save data at the specified interval. The operation stops when you press the Logging Stop function key or when the specified number of data values are saved.

The file name is LOGxx.CSV (xx: a sequence number between 00 and 99).

Note

- If the save method is set to Logging and the battery power in the CA700 is low when you start data logging, the message "Continue Logging?" will appear. To proceed, press ENTER. To cancel, press ESC.
- If the battery power drops so much that the CA700 cannot continue data logging, it will show the message "System has Stopped Logging" and stop data logging. The data logged up to that point will be saved. Before you start data logging, check that there is sufficient battery power.

Save Interval

This is the data save interval that is used when the save method is set to Logging.

You can select 1 s, 2 s, 5 s, 10 s, 30 s, or 60 s.

Number of Data Values to Save

This is the number of data values to save when the save method is set to Logging.

You can set the value between 1 and 2000.

When the CA700 saves the specified number of data values, it will stop saving.

4.2 Deleting Files

Procedure

1. From the top menu, use the ▲ or ▼ key to select **File**, and press **ENTER**.

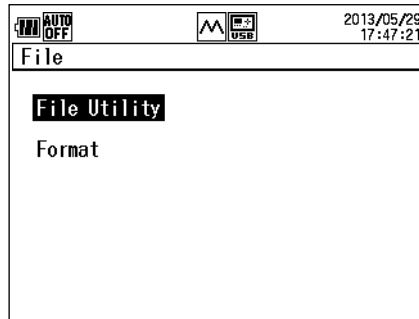

2. Use the ▲ or ▼ key to select **File Utility**, and press **ENTER**.

The screenshot shows the 'File Utility' menu with a list of files. The top status bar shows 'AUTO OFF', a USB icon, and the date/time '2013/05/29 17:47:36'. The menu title is 'File Utility' and the page indicator is '1 / 8'. The file list is as follows:

File Name	Date	Time
LEAK00.CSV	2013/05/10	15:34
LEAK01.CSV	2013/05/16	14:09
LEAK02.CSV	2013/05/17	16:10
LEAK03.CSV	2013/05/17	16:14
LEAK04.CSV	2013/05/20	08:26
LOG00.CSV	2013/05/09	11:38
LOG01.CSV	2013/05/09	11:57
LOG02.CSV	2013/05/09	12:48 ↓

At the bottom of the menu, there are four buttons: 'Delete', 'Toggle Sel', and 'Reset Sel'.

3. Use the ▲ or ▼ key to select the file to delete. Press ◀ or ▶ to scroll by pages.

To select multiple files, use the ▲ or ▼ key to select the file you want to delete, and then press **ENTER**. A check mark appears next the name of the file to indicate that it will be deleted. Likewise, select other files that you want to delete.

To clear a check mark, press **ENTER** again.

Pressing **Toggle Sel (F4)** will clear check marks from all files that have them and add check marks for all files that do not.

To clear all selections, press **Reset Sel (F5)**.

To select all files, press **Reset Sel (F5)** and then **Toggle Sel (F4)**.

Marks indicating selected files

The screenshot shows the 'File Utility' menu with the same file list as before. The top status bar shows 'AUTO OFF', a USB icon, and the date/time '2013/05/29 17:48:33'. The menu title is 'File Utility' and the page indicator is '1 / 8'. The file list is as follows:

File Name	Date	Time
LEAK00.CSV	2013/05/10	15:34
LEAK01.CSV	2013/05/16	14:09
LEAK02.CSV	2013/05/17	16:10
LEAK03.CSV	2013/05/17	16:14
LEAK04.CSV	2013/05/20	08:26
LOG00.CSV	2013/05/09	11:38
LOG01.CSV	2013/05/09	11:57
LOG02.CSV	2013/05/09	12:48 ↓

At the bottom of the menu, there are four buttons: 'Delete', 'Toggle Sel', and 'Reset Sel'. The 'Select:2' indicator is visible above the 'Delete' button.

Number of selected files

Clears all selections

Executes deleting

Unselects all selected files and selects all unselected files

4. Press **Delete (F1)**. A confirmation message will appear. Press **ENTER**. The selected files will be deleted. To cancel deleting, press **ESC**.

Explanation

You can delete files that are saved in the CA700 internal memory.

You cannot save more than 100 files of each type of data: Save data files, Logging data files, and calibration data files. In addition, you cannot save more than 250 files total.

If the maximum number of files that can be saved is reached, you must delete some files.

Copying Files

Before deleting files, copy the important files using one of the following two methods.

- Copy to a USB storage device (see section 4.3)
- Connect the CA700 to a PC through USB, and on the PC, copy the files in the CA700 to a separate storage device (see section 5.4).

4.3 Copying Files to a USB Storage Device

Procedure

Setting the USB Connection

1. From the top menu, use the ▲ or ▼ key to select **Device Setting**, and press **ENTER**.

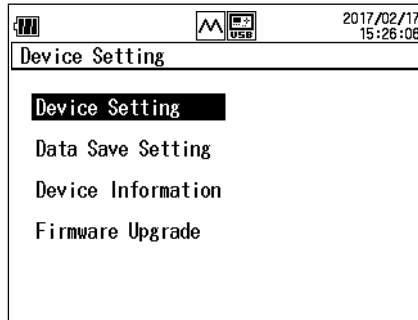

2. Then, use the ▲ or ▼ key again to select **Device Setting**, and press **ENTER**.
The Device Setting screen appears.

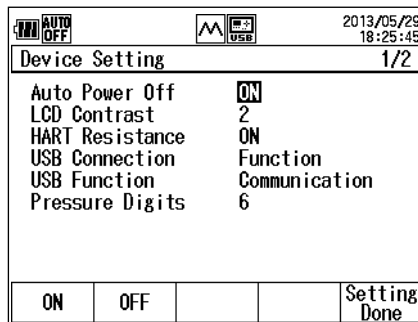

3. Press the ▲ or ▼ key to select **USB Connection**.
Host and Function appear on the function menu.

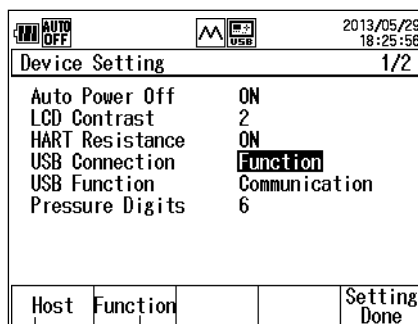

4. Press **Host (F1)**.
5. Press **Setting Done (F5)**. The setting is confirmed, and the Device Setting screen (step 1) returns.
6. Turn off the CA700 and then turn it back on.
To activate USB connection setting, you need to restart the CA700. If you did not change the USB connection setting, you do not have to restart the CA700.

Copying Files to a USB Storage Device

7. Connect a USB storage device to the CA700 USB port (USB A type).
8. From the top menu, use the ▲ or ▼ key to select File, and press ENTER.

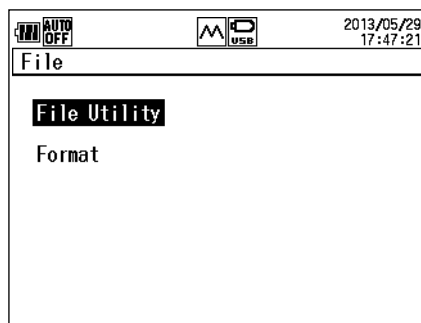

9. Use the ▲ or ▼ key to select File Utility, and press ENTER.

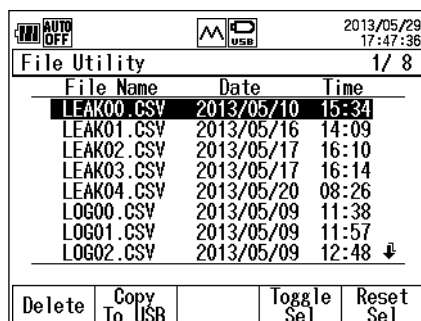

10. Use the ▲ or ▼ key to select the file to copy. Press ◀ or ▶ to scroll by pages.

To select multiple files, use the ▲ or ▼ key to select the file you want to copy, and then press **ENTER**. A check mark appears next the name of the file to indicate that it will be copied. Likewise, select other files that you want to copy.

To clear a check mark, press **ENTER** again.

Pressing **Toggle Sel (F4)** will clear check marks from all files that have them and add check marks for all files that do not.

To clear all selections, press **Reset Sel (F5)**.

To select all files, press **Reset Sel (F5)** and then **Toggle Sel (F4)**.
11. Press **Copy To USB (F2)**. A confirmation message will appear. Press **ENTER**. The selected files will be copied to the USB storage device. To cancel copying, press ESC.

If a file with the same name exists at the destination, an overwrite confirmation message will appear. You can press any of the following keys.

 - ESC: Cancels copying
 - ENTER: Copies by overwriting the existing file
 - F1: Does not overwrite the corresponding file and continues to the next file

Explanation

Setting the USB Connection

The CA700 has a USB port for hosts (A type) and another for functions (mini-B type). Select which connector you want to use. You cannot use the two ports simultaneously.

USB for host: Select this option when connecting a USB storage device to the CA700.

USB for function: Select this option when connecting the CA700 to a PC. This is for controlling the CA700 from a PC using communication commands and for using the CA700 as a mass storage device on the PC.

Icon

When USB Connection is set to Host, the  icon appears on the screen.

Connecting a USB Storage Device

When you connect a USB storage device to the CA700 USB port, note the following points.

- The only USB storage device that the CA700 can use is USB memory device. Do not connect other types of USB storage devices.
- Use USB memory devices that are compatible with USB Mass Storage Class version 1.1.
- Connect the USB memory device directly, not through a USB hub.
- If you turn on the CA700 with a USB memory device connected, the CA700 may not run properly. In such a case, turn off the power once, remove the USB memory device, and then turn it on again. After turning off the power, wait at least 10 seconds before you turn it back on.
- Do not remove and connect a USB memory device at short intervals. Provide a 10-second interval between removal and connection.
- It takes 20 to 30 seconds after you turn the CA700 on until you can start using the keys. Do not remove or connect a USB memory device during this period.
- You can connect only a single USB memory device to the CA700.

4.4 Formatting Internal Memory

CAUTION

If you format the CA700 internal memory, all measured data will be deleted. Before you format the memory, copy important data to a USB storage device or copy to a separate mass storage device using a PC.

Procedure

1. From the top menu, use the ▲ or ▼ key to select **File**, and press **ENTER**.

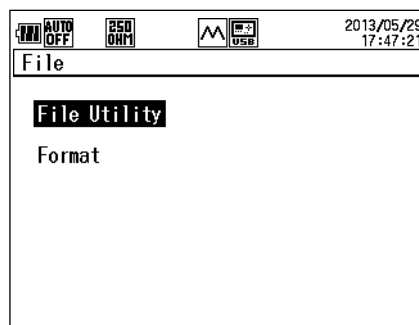

2. Use the ▲ or ▼ key to select **Format**, and press **ENTER**.

The Format screen appears.

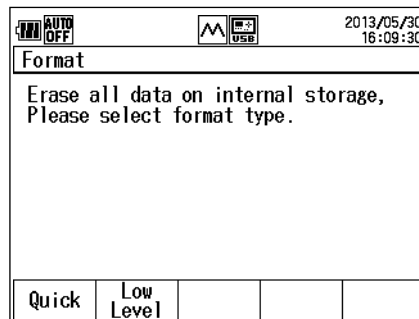

3. Press **Quick (F1)** or **Low Level (F2)**.
A format confirmation message appears.
Low Level is for physical formatting. It will take a long time to format.
4. Press **ENTER**. Formatting will start.
When formatting is completed, the Format screen of step 2 returns.

Explanation

You can format the internal memory in one of the following two ways.

Quick: Quick format. Bad clusters will not be checked. Formatting takes a shorter amount of time.

Low Level: Physical format. Formatting takes a longer amount of time.

5.1 Connecting the CA700 to Your PC

USB Port

The CA700 has two USB ports.

To communicate with a PC, use the mini-B USB port.

USB type-B port (Mini-B)
 Used to control the CA700 from a PC through communication commands or to access the CA700 internal memory from a PC.

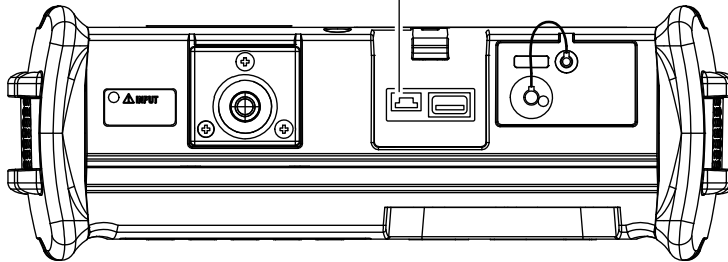

USB Interface Specifications

Electrical and mechanical specifications	USB 1.1
Connector	Type B (Mini-B, receptacle)
Number of ports	1
Power supply	Self powered
PC system requirements	A PC running Windows 7, Windows 8, or Windows 10 with a standard USB port. (To connect the CA700 to a PC and control the CA700 remotely using communication commands, you need a separate device driver.)

5.2 Setting the USB Parameters

Procedure

Setting the USB Connection

1. From the top menu, use the ▲ or ▼ key to select **Device Setting**, and press **ENTER**.

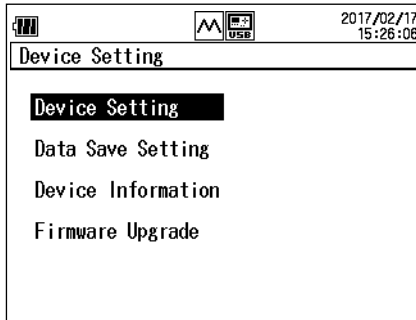

2. Then, use the ▲ or ▼ key again to select **Device Setting**, and press **ENTER**.
The Device Setting screen appears.

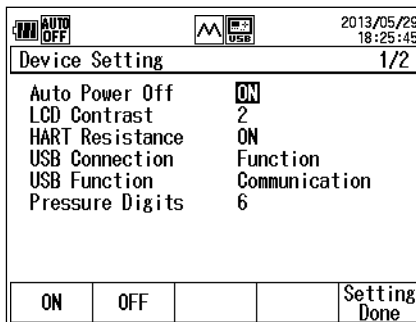

3. Press the ▲ or ▼ key to select **USB Connection**.
Host and Function appear on the function menu.

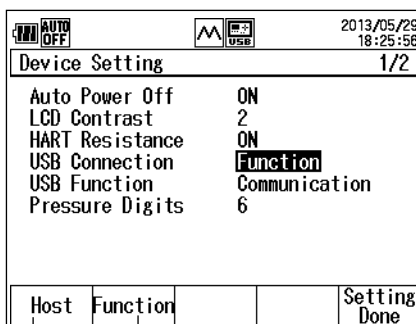

Select to connect to the PC.
Select to connect a mass storage device.

4. Press **Function (F2)**.

Setting the USB Function

5. Press the ▲ or ▼ key to select **USB Function**.
Mass Storage and Comm. appear on the function menu.

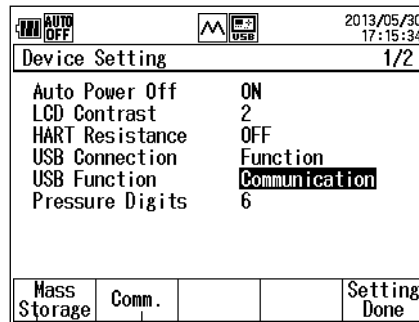

To remotely control the CA700 with communication commands
Select to use the CA700 as a USB storage device on the PC.

6. Press **Mass Storage (F1)** or **Comm. (F2)**.
7. Press **Setting Done (F5)**. The setting is confirmed, and the Device Setting screen (step 1) returns.
8. Turn off the CA700 and then turn it back on.
To activate USB connection setting, you need to restart the CA700. If you did not change the USB connection setting, you do not have to restart the CA700.

Explanation

Setting the USB Connection

The CA700 has a USB port for hosts (A type) and another for functions (mini-B type). Select which connector you want to use. You cannot use the two ports simultaneously.

USB for host: Select this option when connecting a USB storage device to the CA700 (see section 4.3).

USB for function: Select this option when connecting the CA700 to a PC. This is for controlling the CA700 from a PC using communication commands and for using the CA700 as a mass storage device on the PC.

Setting the USB Function

The USB Function setting is valid when USB Connection is set to Function.

Mass Storage: You can use the CA700 internal memory as USB storage device from a PC. From a PC, you can access the files that are saved in the CA700 internal memory.

Comm. (Communication): You can use communication commands to remotely control the CA700 from a PC.

5.3 List of Commands

Item	Command	Description	Normal	User Adjustment
Data retrieval	OD	Requests to send measured data.	Yes	Yes
Measure and source	MS	Sets or queries the measurement/source mode.	Yes	No
Measurement function	MR	Sets or queries the measurement range.	Yes	No
	HD	Holds or queries the measurement value display.	Yes	No
	LT	Starts or stops a leak test.	Yes	No
	PZ	Executes pressure zero calibration.	Yes	No
	TO	Starts or stops data logging.	Yes	No
	TS	Executes manual saving.	Yes	No
Source function	SD	Sets or queries the normal source value.	Yes	No
	SO	Starts or stops or queries the source.	Yes	No
Adjustment	SY	Switches or queries the normal/adjustment mode.	Yes	Yes
	CL	Sets or queries the adjustment item.	No	Yes
	CP	Sets the adjustment point.	No	Yes
	CMF	Sets or queries the adjustment measurement function.	No	Yes
	CMR	Sets or queries the adjustment measurement range.	No	Yes
	CS	Confirms measurement data during measurement adjustment.	No	Yes
	CSF	Queries the adjustment source function.	No	Yes
	CR	Sets or queries the source adjustment value.	No	Yes
	CD	Sets the source value for adjustment.	No	Yes
	CW	Writes adjustment data.	No	Yes
Source/measurement settings	MF	Sets or queries the normal measurement function.	Yes	No
	SF	Sets or queries the source function.	Yes	No
	LP	Sets or queries the leak test leak period.	Yes	No
	PU	Sets or queries the pressure unit.	Yes	No
	AG	Sets or queries averaging.	Yes	No
	SC	Sets and queries the scaling.	Yes	No
	SP	Sets and queries % span.	Yes	No
Device settings	AP	Sets or queries the auto power-off feature.	Yes	No
	DT	Sets or queries the date/time.	Yes	Yes
	LC	Sets or queries the LCD contrast.	Yes	No
	LG	Sets or queries the language.	Yes	No
	TD	Sets or queries the number of log points.	Yes	No
	TM	Sets or queries the data save method.	Yes	No
	TR	Sets or queries the logging interval.	Yes	No
	IO	Sets or queries the on/off state of the 250 Ω internal resistor.	Yes	No
	PD	Sets or queries the number of pressure display digits.	Yes	No
Other	OE	Outputs error information.	Yes	Yes
	YC	Initializes measurement settings.	Yes	No
	ESC S	Outputs the status byte.	Yes	Yes
	H	Sets or queries the presence or absence of output data headers.	Yes	Yes
	IM	Sets or queries the status byte mask.	Yes	Yes
	BL	Sets or queries the on/off state of the backlight.	Yes	Yes
	ZC	Initializes the zero calibration value.	Yes	No
	XR	Queries the MAX range.	Yes	Yes
	BSN	Queries the serial number.	Yes	Yes
	BGD	Queries the calibration date.	Yes	Yes
	FCN	Queries the connection state of the external pressure sensor.	Yes	Yes
	FMN	Queries the model number of the external sensor.	Yes	Yes
	FSN	Queries the serial number of the external sensor.	Yes	Yes
	FGD	Queries the calibration date of the external sensor.	Yes	Yes
	UD	Sets the user calibration date of the CA700.	Yes	Yes
	RUD	Queries the user calibration date of the CA700.	Yes	Yes
	EUD	Sets the user calibration date of the external pressure sensor.	Yes	Yes
REU	Queries the user calibration date of the external pressure sensor.	Yes	Yes	

5.4 Commands

Command Syntax

The command syntax is explained below.

Setting/Control

Command: Transmission command format

Answer: Response data format without response (setting/control)

When an error occurs, the same data as the error message ERRm (m = error number) that is displayed on the screen is returned.

Queries

Command: Transmission command format

Return: Response data format with response (queries)

Mode-specific conditions

Normal: Can be used for normal measurement/source operation.

Adjustment: Can be used in adjustment mode.

[AG command] Sets or queries averaging.

AG	Sets or queries averaging.	Normal	Adjustment
	Command = AGmn<CRLF> → Answer = AGmn<CRLF> Command = AGm?<CRLF> → Return = AGmn<CRLF>	Yes	No
	Parameters m = 0: GROUP item A 1: GROUP item B n = 0: OFF 1: ON		

[AP command] Sets or queries the auto power-off feature.

AP	Sets or queries the auto power-off feature.	Normal	Adjustment
	Command = APm<CRLF> → Answer = APm<CRLF> Command = AP?<CRLF> → Return = APm<CRLF>	Yes	No
	Parameters m = 0: OFF 1: 60 min (default value)		

[BGD command] Queries the calibration date.

BGD	Queries the calibration date.	Normal	Adjustment
	Command = BGD?<CRLF> → Answer = BGDm,yyyymmdd<CRLF>	Yes	Yes
	Parameters m = 0: Delivery inspection date 1: Factory calibration date 2: User calibration date yyyy: Year 4byte, mm: Month 2byte, dd: Day 2byte		

[BL command] Sets or queries the on/off state of the backlight.

BL	Sets or queries the on/off state of the backlight.	Normal	Adjustment
	Command = BLm<CRLF> → Answer = BLm<CRLF> Command = BL?<CRLF> → Return = BLm<CRLF>	Yes	Yes
	Parameters m = 0: Off (default value) 1: On		

5.4 Commands

[BSN command] Queries the serial number.

BSN	Queries the serial number.	Normal	Adjustment
	Command = BSN?<CRLF> → Answer = xxxxxxxx<CRLF>	Yes	Yes
	Parameters xxxxxxx : serial number		

[CD command] Sets the source value for adjustment.

CD	Sets the source value for adjustment.	Normal	Adjustment
	Command = CD<CRLF> → Answer = CD<CRLF>	No	Yes
	In the source adjustment condition, the current output settings are set as the source adjustment values for the selected function, range, and scale (+FS/0). When the function is set to measurement, ERR13 is returned.		

[CL command] Queries the adjustment item.

CL	Queries the adjustment item.	Normal	Adjustment
	Command = CL?<CRLF> → Return = CLm<CRLF>	No	Yes
	Parameters m = 3: Source adjustment 4: Measurement adjustment		

[CMF command] Sets or queries the measurement function for adjustment.

CMF	Sets or queries the measurement function for adjustment.	Normal	Adjustment
	Command = CMFm<CRLF> → Answer = CMFm<CRLF> Command = CMF?<CRLF> → Return = CMFm<CRLF>	No	Yes
	Parameters m = 0: DCV 12: DCmA 13: LOOP POWER 14: Pressure 15: Switch Test When the function is set to measurement, ERR13 is returned.		

[CMR command] Sets or queries the measurement range for adjustment.

CMR	Sets or queries the measurement range for adjustment.	Normal	Adjustment
	Command = CMRm<CRLF> → Answer = CMRm<CRLF> Command = CMR?<CRLF> → Return = CMRm<CRLF>	No	Yes
	Parameters [DCV] 1: 5 V 3: 50 V [DCA] m = 0: 20 mA 1: 100 mA [LOOP POWER] m = 0: 20 mA [SWITCH TEST] m = 0: 2 kΩ When the function is set to measurement, ERR13 is returned.		

[CP command] Sets the adjustment point.

CP	Sets the adjustment point.	Normal	Adjustment
	Command = CPm<CRLF> → Answer = CPm<CRLF>	No	Yes
	Parameters m = 0: +FS adjustment 1: +zero adjustment 2: -FS adjustment 3: -zero adjustment 4: +FS adjustment (monitor measurement) 5: +zero adjustment (monitor measurement)		

[CR command] Sets or queries the source adjustment value for adjustment.

CR	Sets or queries the source adjustment value for adjustment.	Normal	Adjustment
	Command = CRm<CRLF> → Answer = CRm<CRLF> Command = CR?<CRLF> → Return = CRm<CRLF>	No	Yes
	Parameters m = 18.000 to +22.000 (DCmA FS adjustment) m = -0.200 to +0.200 (DCmA zero adjustment) m = 18.000 to +22.000 (DCmA SIMULATE FS adjustment) m = 0.900 to +1.100 (DCmA SIMULATE zero adjustment) m = 4.5000 to +5.5000 (DCV FS adjustment) m = -0.0500 to +0.0500 (DCV zero adjustment)		

[CS command] Sets the measurement value for adjustment.

CS	Sets the measurement value for adjustment.	Normal	Adjustment
	Command = CS<CRLF> → Answer = CS<CRLF>	No	Yes
	In the measurement adjustment condition, the current input measured values are set as the measurement adjustment values for the selected function, range, and scale (+FS/+0/-0/-FS).		

[CSF command] Queries the source function for adjustment.

CSF	Queries the source function for adjustment.	Normal	Setting
	Command = CSF?<CRLF> → Return = CSFm<CRLF>	No	Yes
	Parameters m = 0: DCV 12: DCmA 16: DCmA SIMULATE		
	When the function is set to measurement, ERR13 is returned.		

[CW command] Writes adjustment data.

CW	Writes adjustment data.	Normal	Adjustment
	Command = CW<CRLF> → Answer = CW,OK<CRLF> (normal completion)	No	Yes
	Writes the adjustment data to the data flash memory after performing adjustments for each function and range. If you turn off the CA700 without executing this command, the values adjusted immediately before will be discarded.		

5.4 Commands

[DT command] Sets or queries the date/time.

DT	Sets or queries the date/time.	Normal	Adjustment
	Command = DTyyyyymmddhhmmss<CRLF> → Answer = DTyyyyymmddhhmmss<CRLF>	Yes	Yes
	Command = DT?<CRLF> → Return = DTyyyy/mm/dd,hh:mm:ss<CRLF>		
	Parameters (default value) yyyy: Gregorian (2013) 4 bytes, mm: month (01) 2 bytes, dd: day (01) 2 bytes hh: hour (00) 2 bytes, mm: minute (00) 2 bytes, ss: second (00) 2 bytes		

[ESC S command] Outputs the CA700 status byte.

ESC S	Outputs the CA700 status byte. ("ESC" = ASCII 0x1B)	Normal	Adjustment
	Command = ESC S<CRLF> → Answer = m<CRLF>	Yes	Yes
	Outputs the status byte as an integer.		

[EUD command] Sets the user calibration date of the external pressure sensor.

EUD	Sets the user calibration date of the external pressure sensor.	Normal	Adjustment
	Command = EUDyyyyymmdd<CRLF>	Yes	Yes
	Parameters yyyy: Year 4byte, mm: Month 2byte, dd: Day 2byte		
	To set the user calibration date of the external pressure sensor, you need to set Function to EXT P or EXT LEAK.		

[FCN command] Sets the user calibration date of the external pressure sensor.

FCN	Queries the connection state of the external pressure sensor.	Normal	Adjustment
	Command = FCN?<CRLF> → Answer = FCNm<CRLF>	Yes	Yes
	Parameters m = 0: Not connected 1: Connected		

[FGD command] Queries the calibration date of the external sensor.

FGD	Queries the calibration date of the external sensor.	Normal	Adjustment
	Command = FGD?<CRLF> → Answer = FGDm,yyyyymmdd<CRLF>	Yes	Yes
	Parameters m = 0: Not calibrated 1: Factory calibration date 2: User calibration date		
	yyyy: Year 4byte, mm: Month 2byte, dd: Day 2byte		
	To set the user calibration date of the external pressure sensor, you need to set Function to EXT P or EXT LEAK.		

[FMN command] Queries the model number of the external sensor.

FMN	Queries the model number of the external sensor.	Normal	Adjustment
	Command = FMN?<CRLF> → Answer = PM100-x-yy-zz<CRLF>	Yes	Yes
	Parameters x: Basic use code 01 yy: Basic use code 02 zz: Basic use code 03		
	To set the user calibration date of the external pressure sensor, you need to set Function to EXT P or EXT LEAK.		

[FSN command] Queries the serial number of the external sensor.

FSN	Queries the serial number of the external sensor.	Normal	Adjustment
	Command = FSN?<CRLF> → Answer = xxxxxxxx<CRLF>	Yes	Yes
	Parameters xxxxxxx : serial number		
	To set the user calibration date of the external pressure sensor, you need to set Function to EXT P or EXT LEAK.		

[H command] Sets or queries the presence or absence of output data (OD) headers.

H	Sets or queries the presence or absence of output data (OD) headers.	Normal	Adjustment
	Command = Hm<CRLF> → Answer = Hm<CRLF> Command = H?<CRLF> → Return = Hm<CRLF>	Yes	Yes
	Parameters m = 0: No headers (default value) 1: With headers		
	This setting is valid until the CA700 is turned off.		

[HD command] Holds or queries the measurement value display.

HD	Holds or queries the measurement value display.	Normal	Adjustment
	Command = HDm<CRLF> → Answer = HDm<CRLF> Command = HD?<CRLF> → Return = HDm<CRLF>	Yes	No
	Parameters m = 0: Display updating (default value) 1: Data hold		

5.4 Commands

[IM command] Sets or queries the status byte detection/mask.

IM	Sets or queries the status byte detection/mask.	Normal	Adjustment
	Command = IMm<CRLF> → Answer = IMm<CRLF> Command = IM?<CRLF> → Return = IMm<CRLF>	Yes	Yes
	<p>Sets whether to detect or mask each status byte bit (queried with the ESC S command; see chapter 6). If you set IM0, all information bits are masked. If you set IM63, all bits reflect the current operating conditions.</p> <p>Parameter m = 0 to 63 1: Detect bit 0 (measurement end) 2: Detect bit 1 (output change end) 4: Detect bit 2 (syntax errors) 8: Detect bit 3 (over-range) 16: Detect bit 4 (24 V loop output error) 32: Detect bit 5 (output errors) (Status byte bits 6 and 7 are fixed.)</p> <p>Default value m = 63 (no masking)</p>		

[IO command] Sets or queries the on/off state of the 250 Ω internal resistor.

IO	Sets or queries the on/off state of the 250 Ω internal resistor.	Normal	Adjustment
	Command = IOm<CRLF> → Answer = IOm<CRLF> Command = IO?<CRLF> → Return = IOm<CRLF>	Yes	No
	<p>Parameters m = 0: 250 Ω resistor off (default value) 1: 250 Ω resistor on</p>		

[LC command] Sets or queries the LCD contrast.

LC	Sets or queries the LCD contrast.	Normal	Adjustment
	Command = LCm<CRLF> → Answer = LCm<CRLF> Command = LC?<CRLF> → Return = LCm<CRLF>	Yes	No
	<p>Parameters m = 0: Contrast level 1 1: Contrast level 2 (default value) 2: Contrast level 3 3: Contrast level 4</p>		

[LG command] Sets or queries the language.

LG	Sets or queries the language.	Normal	Adjustment
	Command = LGm<CRLF> → Answer = LGm<CRLF> Command = LG?<CRLF> → Return = LGm<CRLF>	Yes	No
	<p>Parameters m = 0: English 1: Japanese 2: Chinese 3: Korean</p>		

[LP command] Sets or queries the leak period.

LP	Sets or queries the leak test leak period.	Normal	Adjustment
	Command = LPhhmmss<CRLF> → Answer = LPhhmmss<CRLF> Command = LP?<CRLF> → Return = LPhhmmss<CRLF>	Yes	No
	Parameters hh: hour (00) 2 bytes, mm: minute (00) 2 bytes, ss: second (00) 2 bytes Default value: 00:10:00		

[LT command] Starts or stops a leak test.

LT	Starts or stops a leak test.	Normal	Adjustment
	Command = LTm<CRLF> → Answer = LTm<CRLF> Command = LT?<CRLF> → Return = LTm<CRLF>	Yes	No
	Parameters m = 0: Leak test end (default value) 1: Leak test start		

[MF command] Sets or queries the normal measurement function.

MF	Sets or queries the measurement function.	Normal	Adjustment
	Command = MFmnn<CRLF> → Answer = MFmnn<CRLF> Command = MFm?<CRLF> → Return = MFmnn<CRLF>	Yes	No
	Parameters m = 0: GROUP A item 1: GROUP B item GROUP A item n = 14: PRESSURE 15: EXTERNAL PRESSURE 17: LEAK TEST 18: EXTERNAL LEAK TEST GROUP B item n = 00: DCV 12: DCmA 13: LOOP POWER		

[MR command] Sets or queries the measurement range.

MR	Sets or queries the measurement range.	Normal	Adjustment
	Command = MRmn<CRLF> → Answer = MRmn<CRLF> Command = MRn?<CRLF> → Return = MRmn<CRLF>	Yes	No
	Parameters m = 0: GROUP A item 1: GROUP B item GROUP A item [PREASSURE] n = 0: 200 kPa 1: 1000 kPa 2: 3500 kPa 3: 7 MPa 4: 10 MPa 5: 16 MPa 6: 25 MPa 7: 50 MPa 8: 70 MPa GROUP B item [DCV] n = 1: 5 V 3: 50 V [DCA] n = 0: 20 mA 1: 100 mA [LOOP POWER] n = 0: 20 mA		

5.4 Commands

[MS command] Sets or queries the measurement/source mode.

MS	Sets or queries the measurement/source mode.	Normal	Adjustment
	Command = MSm<CRLF> → Answer = MSm<CRLF> Command = MS?<CRLF> → Return = MSm<CRLF>	Yes	No
	Parameters m = 0: Measurement mode (default value) 1: Source Mode		

[OD command] Requests to send measured data.

OD	Outputs the measured value.	Normal	Adjustment
	Command = ODm<CRLF> → Return = abbbbbbcsdddddeee<CRLF> m = 0: GROUP A item 1: GROUP B item	Yes	Yes
	Parameters <Header section (8 bytes)> a = V: voltage/A: current/P: pressure bbbbbb = DC___: DC BAR___: bar PAz___: Pa ATMz___: atm SCAL___: when scaling is on z: Gauge pressure G, absolute pressure A c = N: normal/O: over-range/E: no data <Data section (11 bytes)> s = sign _: positive/-: negative (underscore represents a space) dddddd = measured value (7 digits) eee = E+0/E+3/E-3/E+6/E-6 (When scaling is on, eee is "E+0.") For over-range: dddddddee = _999999.E+9 For no data: dddddd = ---.--- (7 digits, the decimal position is according to the currently set unit) eee = E+0/E+3/E-3/E+6/E-6		
	Note In the following situations, measurement output will be invalid data (no data). • GROUP A item For about 1.8 seconds after starting the power supply For about 1.8 seconds after changing the function When the external pressure sensor is disconnected (the function is EXT P or EXT LEAK) • GROUP B item For about 300 milliseconds after starting the power supply For about 300 milliseconds after changing the function		
	Output example DCV: VDCN__0.000E+0 DCmA: ADCN__0.000E-3		

[OE command] Outputs error information.

OE	Outputs error information.	Normal	Adjustment
	Command = OE<CRLF> → Return = ERRm<CRLF>	Yes	Yes
	Outputs the most recent error. After returning the error, the saved error number is overwritten with "ERR00<CRLF>." "ERR00<CRLF>" is returned when there is no error.		
	Parameters m = Error code number (See "Error Codes.")		

[PD command] Sets or queries the number of pressure display digits.

PD	Sets or queries the number of pressure display digits.	Normal	Adjustment
	Command = PDm<CRLF> → Answer = PDm<CRLF>	Yes	No
	Command = PD?<CRLF> → Return = PDm<CRLF>		
	Parameters m = 0: 6 digits (default value) 1: 5 digits		

[PU command] Sets or queries the pressure unit.

PU	Sets or queries the pressure unit.	Normal	Adjustment
	Command = PUm<CRLF> → Answer = PUm <CRLF>	Yes	No
	Command = PUm?<CRLF> → Return = PUm <CRLF>		
	Parameters m = 0: DISPLAY1 item 1: DISPLAY2 item n = 00: mbar 01: bar 02: Pa 03: hPa 04: kPa (default value) 05: MPa 06: atm 07: mmHg 08: inHg 09: gf/cm ² 10: kgf/cm ² 11: mmH ₂ O@4°C 12: mmH ₂ O@20°C 13: torr 14: psi 15: inH ₂ O@4°C 16: inH ₂ O@20°C 17: ftH ₂ O@4°C 18: ftH ₂ O@20°C		

5.4 Commands

[PZ command] Executes zero calibration on the pressure value.

PZ	Executes zero calibration on the pressure value.	Normal	Adjustment
	Command = PZm<CRLF> → Answer = PZ,OK<CRLF>	Yes	No
	Parameters m = 0: Internal sensor		

[REU command] Queries the user calibration date of the external pressure sensor.

REU	Queries the user calibration date of the external pressure sensor.	Normal	Adjustment
	Command = REU?<CRLF> → Return = REUyyyymmdd<CRLF>	Yes	Yes
	Parameters yyyy: Year 4byte, mm: Month 2byte, dd: Day 2byte		
	To set the user calibration date of the external pressure sensor, you need to set Function to EXT P or EXT LEAK.		

[RUD command] Queries the user calibration date of the CA700.

RUD	Queries the user calibration date of the CA700.	Normal	Adjustment
	Command = RUD?<CRLF> → Return = RUDyyyymmdd<CRLF>	Yes	Yes
	Parameters yyyy: Year 4byte, mm: Month 2byte, dd: Day 2byte		

[SC command] Sets and queries the scaling.

SC	Sets and queries the scaling.	Normal	Adjustment
	Command = SCmn,o,p,q,r,s,t,u<CRLF> → Answer = SCmn,o,p,q,r,s,t,u <CRLF> Command = SCm?<CRLF> → Return = SCmn,o,p,q,r,s,t,u <CRLF>	Yes	No
	Parameter		
	m = 0: GROUP item A 1: GROUP item B		
	GROUP item A settings		
	n = 0: OFF (default value) 1: ON		
	o = Span lower limit		
	p = Span upper limit -999999 to 000000 to 999999 (decimal point ignored)		
	q = Span decimal point position 0: 000000 1: 00000.0 2: 0000.00 3: 000.000 4: 00.0000 5: 0.00000		
	r = Scale lower limit		
	s = Scale upper limit -999999 to 000000 to 999999 (decimal point ignored)		
	t = Scale decimal point position 0: 000000 1: 00000.0 2: 0000.00 3: 000.000 4: 00.0000 5: 0.00000		
	u = Scale unit Up to 15 one-byte alphanumeric characters and symbols that can be set on the main unit		
	GROUP item B settings		
	n = 0: OFF (default value) 1: ON		
	o = Span lower limit		
	p = Span upper limit -99999 to 00000 to 99999 (decimal point ignored)		
	q = Span decimal point position (fixed to 0)		
	r = Scale lower limit		
	s = Scale upper limit -99999 to 00000 to 99999 (decimal point ignored)		
	t = Scale decimal point position 0: 00000 1: 0000.0 2: 000.00 3: 00.000 4: 0.0000		
	u = Scale unit Up to 15 one-byte alphanumeric characters and symbols that can be set on the main unit		
	o and subsequent parameters are optional (when they are omitted, their current settings remain unchanged)		

5.4 Commands

[SD command] Sets or queries the source value.

SD	Sets or queries the source value.	Normal	Adjustment
	Command = SDm<CRLF> → Answer = SDm<CRLF> Command = SD?<CRLF> → Return = SDm<CRLF>	Yes	No
	Parameters m = Source value DCmA m = 0.000 to 24.000 DCV m = 0.0000 to 5.5000		
	When the function is set to measurement, ERR13 is returned.		

[SF command] Sets or queries the source function.

SF	Sets or queries the source function.	Normal	Adjustment
	Command = SFmn<CRLF> → Return = SFmn<CRLF> Command = SFm?<CRLF> → Return = SFmn<CRLF>	Yes	No
	Parameters m = 1: GROUP B item GROUP B item n = 00: DCV 12: DCmA 16: mA Simulate		
	When the function is set to measurement, ERR13 is returned.		

[SO command] Starts or stops or queries the source.

SO	Starts or stops or queries the source.	Normal	Adjustment
	Command = SOM<CRLF> → Answer = SOM<CRLF> Command = SO?<CRLF> → Return = SOM<CRLF>	Yes	No
	Parameters m = 0: Source end (default value) 1: Source start		
	When the function is set to measurement, ERR13 is returned.		

[SP command] Sets and queries % span.

SP	Sets and queries % span.	Normal	Adjustment
	Command = SPmn,o,p<CRLF> → Answer = SPmn,o,p<CRLF> Command = SPm?<CRLF> → Return = SPmn,o,p<CRLF>	Yes	No
	Parameters m = 0: GROUP item A 1: GROUP item B GROUP item A settings n = 0: OFF (default value) 1: ON o = Span lower limit p = Span upper limit -999999 to 000000 to 999999 (decimal point ignored) GROUP item A settings n = 0: OFF (default value) 1: ON o = Span lower limit p = Span upper limit -999999 to 000000 to 999999 (decimal point ignored) o and subsequent parameters are optional (when they are omitted, their current settings remain unchanged).		

[SY command] Switches between normal mode and user adjustment mode.

SY	Switches or queries the normal/adjustment mode.	Normal	Adjustment
	Command = SYm<CRLF> → Answer = SYm<CRLF> Command = SY?<CRLF> → Return = SYm<CRLF>	Yes	Yes
Parameters			
m = 0: Normal mode (default value) 1: User adjustment mode			

[TD command] Sets or queries the number of log points.

TD	Sets or queries the number of log points.	Normal	Adjustment
	Command = TDm<CRLF> → Answer = TDm<CRLF> Command = TD?<CRLF> → Return = TDm<CRLF>	Yes	No
Parameters			
m = 1 to 2000 (default value: 1)			

[TM command] Sets or queries the data save method.

TM	Sets or queries the data save method.	Normal	Adjustment
	Command = TMm<CRLF> → Answer = TMm<CRLF> Command = TM?<CRLF> → Return = TMm<CRLF>	Yes	No
Parameters			
m = 0: SAVE (default value) 1: LOGGING			

[TO command] Starts, stops, or queries the logging condition.

TO	Starts, stops, or queries the logging condition.	Normal	Adjustment
	Command = TOm<CRLF> → Answer = TOm<CRLF> Command = TO?<CRLF> → Return = TOm<CRLF>	Yes	No
Parameters			
m = 0: Logging stop (default value) 1: Logging start			

[TR command] Sets or queries the logging interval.

TR	Sets or queries the logging interval.	Normal	Adjustment
	Command = TRm<CRLF> → Answer = TRm<CRLF> Command = TR?<CRLF> → Return = TRm<CRLF>	Yes	No
Parameters			
m = 0: 1 s (default value) 1: 2 s 2: 5 s 3: 10 s 4: 30 s 5: 60 s			

[TS command] Executes manual saving.

TS	Sets the user calibration date of the CA700.	Normal	Adjustment
	Command = TS<CRLF> → Answer = TS,OK<CRLF>	Yes	No

5.4 Commands

[UD command] Sets the user calibration date of the CA700.

UD	Executes manual saving.	Normal	Adjustment
	Command = UDyyyyymmdd<CRLF>	Yes	Yes
	Parameters yyyy: Year 4byte, mm: Month 2byte, dd: Day 2byte		

[XR command] Queries the MAX range.

XR	Queries the MAX range.	Normal	Adjustment
	Command = XRm?<CRLF> → Return = XRmn<CRLF>	Yes	Yes
	Parameters m = 0: Internal pressure sensor 1: External pressure sensor n = 0: 200 kPa range 1: 100 kPa range 2: 3500 kPa range 5: 16 MPa range 8: 70 MPa range To set the user calibration date of the external pressure sensor, you need to set Function to EXT P or EXT LEAK.		

[YC command] Initializes measurement settings.

YC	Initializes measurement settings.	Normal	Adjustment
	Command = YCmn<CRLF> → Answer = YCm, OK<CRLF>	Yes	No
	Parameters m = 0: GROUP A item 1: GROUP B item n = 1: Executes initialization		

[ZC command] Initializes the zero calibration value.

ZC	Initializes the zero calibration value.	Normal	Adjustment
	Command = ZCm<CRLF> → Answer = ZC, OK<CRLF>	Yes	No
	Parameters m = 1: Executes initialization		

5.5 Status Byte Format

Device Status Byte

Status byte format (see the explanation of the <ESC S> command)

bit 7	bit 6	bit 5	bit 4	bit 3	bit 2	bit 1	bit 0
0 (fixed)	1 (fixed)	Output error	24 V power supply error	Over-range	Syntax error	Output change completion	Measurement complete

bit 7: Fixed to 0.

bit 6: Fixed to 1.

bit 5: Set to 1 when an error occurs during output.
The information is retained until the status byte is read.

bit 4: Set to 1 when an error occurs in the 24 V loop measurement power supply.
The information is retained until the status byte is read.

bit 3: Set to 1 when a measurement over-range occurs.
In auto-range operation, this bit is set to 1 when the CA700 switches to the higher range.
The information is retained until the status byte is read.

bit 2: Set to 1 when a prohibited operation or command is processed, when the command cannot be interpreted, or when a parameter is outside the setting range.
The information is retained until the status byte is read.

bit 1: Set to 1 when the output stabilizes after it is changed with the output turned on.
The information is retained until the status byte is read.

bit 0: Set to 1 when measured data is confirmed during measurement.
The information is retained until the status byte is read.

5.6 Connecting the CA700 to Your PC as a USB Storage Device

Setting USB Parameters

In the USB settings of section 5.2, set USB Connection to Function and USB Function to Mass Storage, and then restart the CA700. If you did not change the USB connection setting, you do not have to restart the CA700.

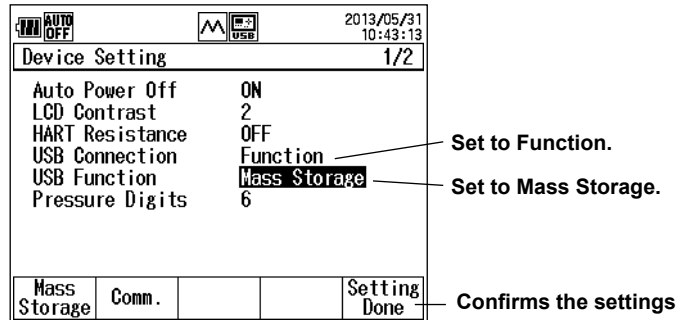

Connecting to Your PC

CAUTION

- When you access the CA700 internal memory from your PC, do not perform any other operation than reading. If you delete data from the internal memory or write data to it, the CA700 may malfunction.
- Do not remove the USB cable or turn off the CA700 while the PC is accessing the CA700 internal memory. If you do, the CA700 may malfunction.

Connect the CA700 to your PC using a USB cable. Connect the cable to the CA700 mini-B USB port (see section 5.2).

The CA700 will be identified as a removable hard drive.

Note

From a PC, you can access only the CA700 internal memory. You cannot access the USB memory device that is connected to the CA700.

6.1 Setting the Auto Power-Off Feature and LCD Contrast and Turning the LCD Backlight On and Off

Procedure

Setting the Auto Power-Off Feature and LCD Contrast

1. From the top menu, use the ▲ or ▼ key to select **Device Setting**, and press **ENTER**.

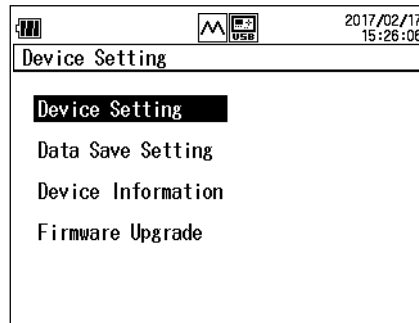

2. Then, use the ▲ or ▼ key again to select **Device Setting**, and press **ENTER**. The Device Setting screen appears.

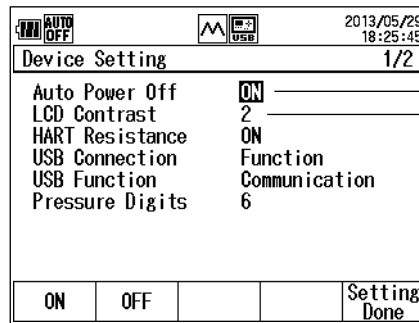

Turn auto power-off on and off
Set the LCD contrast.

Turn auto power-off on and off

3. Press the ▲ or ▼ key to select **Auto Power Off**.
ON and OFF appear on the function menu.
4. Press **ON (F1)** or **OFF (F2)**. Selecting ON will enable the auto power-off feature.

Setting the LCD Contrast

5. Press the ▲ or ▼ key to select **LCD Contrast**.
The numbers 1 to 4 appear on the function menu.
6. Press any of the **1 (F1)** to **4 (F4)** keys. Contrast is lowest at 1 and highest at 4.

Confirming the Settings

7. Press **Setting Done (F5)**. The settings are confirmed.

Turns on and off the LCD backlight.

1. Press  on the CA700 front panel. Each time you press the key, the LCD backlight toggles on and off.

Explanation

Auto Power-off

When the auto power-off feature is enabled, "AUTO OFF" appears on the screen, and the CA700 automatically turns off if there is no user interaction for about 60 minutes.

However, the auto power-off feature is disabled in the following instances.

- While measurement data is being logged
- While min/max values are being measured
- During a leak test

If the CA700 turns off because of the auto power-off feature, turn the CA700 on again.

LCD Contrast

You can set the contrast between 1 (lowest) and 4 (highest).

Turning the LCD Backlight On or Off

If the CA700 is used in a dark place, turning on the backlight will make the screen easier to see.

If you want to save battery power, you can turn off the backlight.

6.2 Setting the HART Resistance and the Number of Pressure Display Digits

Procedure

1. From the top menu, use the ▲ or ▼ key to select **Device Setting**, and press **ENTER**.

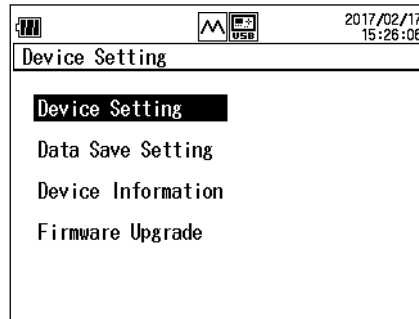

2. Then, use the ▲ or ▼ key again to select **Device Setting**, and press **ENTER**.
The Device Setting screen appears.

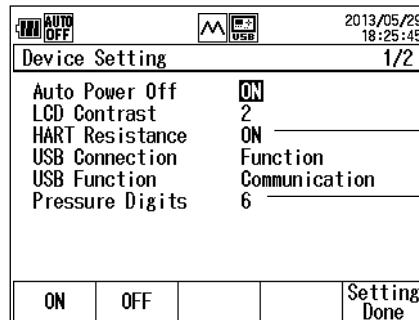

Turning HART Resistance On or Off

3. Press the ▲ or ▼ key to select **HART Resistance**.
ON and OFF appear on the function menu.
4. Press **ON (F1)** or **OFF (F2)**.

Setting the Number of Pressure Display Digits

5. Press the ▲ or ▼ key to select **Pressure Digits**.
The numbers 5 and 6 appear on the function menu.
6. Press **5 (F1)** or **6 (F2)**.

Confirming the Settings

7. Press **Setting Done (F5)**. The settings are confirmed.

Explanation

HART Resistance

You can turn the internal 250 Ω resistor on and off.

If you want to use 24 V loop power supply or current source in a HART or BRAIN communication system, turn the resistor on.

When HART resistance is set to ON,  appears on the screen.

Number of Pressure Display Digits

You can set the number of pressure display digits to five or six.

The number of digits right of the decimal will change.

Data saved to files and communication command responses are always six digits regardless of this setting.

6.3 Setting the Decimal Point and the Separator for CSV Data

Procedure

1. From the top menu, use the ▲ or ▼ key to select **Device Setting**, and press **ENTER**.

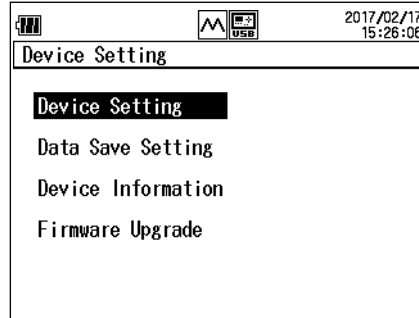

2. Then, use the ▲ or ▼ key again to select **Device Setting**, and press **ENTER**.
The Device Setting screen 1/2 appears.
3. Keep pressing the ▲ or ▼ key until Device Setting 2/2 appears.

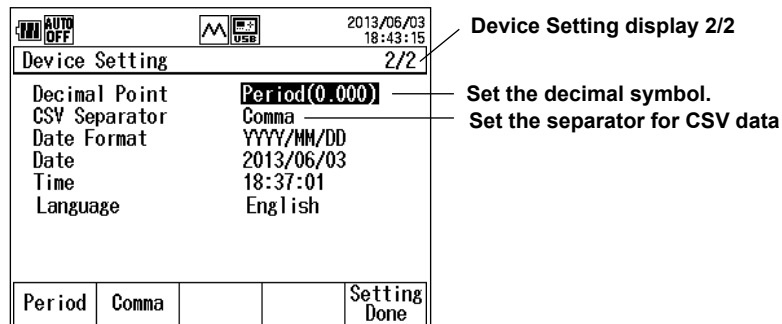

Setting the Decimal Symbol

4. Press the ▲ or ▼ key to select **Decimal Point**.
Period and Comma appear on the function menu.
5. Press **Period (F1)** or **Comma (F2)**.

Setting the Separator for CSV Data

6. Press the ▲ or ▼ key to select **CSV Separator**.
Comma, Semi colon, and Tab appear on the function menu.
7. Press **Comma (F1)**, **Semi colon (F2)**, or **Tab (F3)**.

Confirming the Settings

8. Press **Setting Done (F5)**. The settings are confirmed.

Explanation

Decimal Symbol

You can set the decimal symbol to a period or comma.

Separator for CSV Data

You can set the separator for the CSV data that will be saved.

You can set it to a comma, semicolon, or tab. CSV data can be opened in Microsoft Excel and other spreadsheet applications.

6.4 Holding Displayed Values and Displaying Min/Max Values

Procedure

Holding Displayed Values

1. When measured values are displayed on the screen, press **HOLD** on the CA700 front panel. HOLD appears on the screen, and the measured values are held. You will only be able to use the HOLD and  keys.

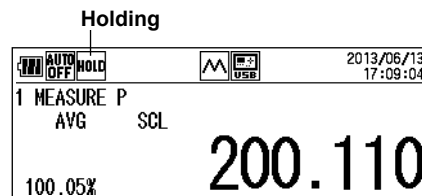

2. To release the hold, press **HOLD** again.

Min/Max Value Display

1. When measured values are displayed on the screen, press **MIN/MAX** on the CA700 front panel. The minimum and maximum values are displayed on the screen.

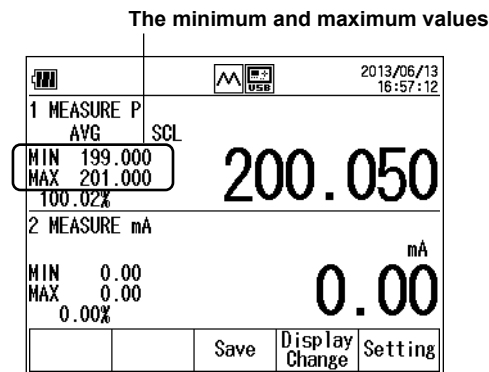

2. To clear them, press **MIN/MAX** again.

Explanation

Holding Displayed Values

You can use the hold feature to hold the display. While the display is held, “HOLD” is displayed at the top of the screen, and you will only be able to use the HOLD and  keys.

Min/Max Value Display

The min/max feature displays the minimum and maximum values of the measured pressure, current and voltage.

This feature is not available during leak pressure measurement.

The following features are disabled while minimum and maximum values are displayed.

- Auto power-off
- Measurement range change
- Relative display (based on the reference value)
- Zero calibration

6.5 Reference Value and Relative Display

Procedure

1. When measured values are displayed on the screen, press **RELATIVE** on the CA700 front panel.
REL appears on the screen, and a relative value based on the reference value is displayed.
If the reference value is assigned to the measured value, when you press RELATIVE, the measured value will become the reference value.

Displaying the difference relative to the reference value Difference relative to the reference value

AUTO OFF		M USB		2013/06/13 17:07:16	
1 MEASURE P		REL AVG		SCL	
100.05%		100.110			
2 MEASURE mA		REL		mA	
0.00%		0.00			
		Save	Display Change	Setting	

2. To return to the normal measurement display, press **RELATIVE** again.

Explanation

You can display relative values based on a reference value by setting the reference value to a specific value or to the measured value when you press the RELATIVE key.

For details on the reference setting method, see section 2.1.

The following features are disabled while relative values are displayed.

- Measurement range change
- Min/Max Display
- Zero calibration

6.6 Setting the Language

Procedure

1. From the top menu, use the ▲ or ▼ key to select **Device Setting**, and press **ENTER**.

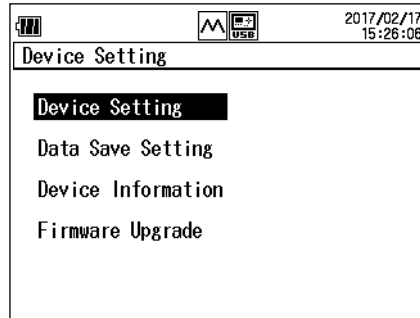

2. Then, use the ▲ or ▼ key again to select **Device Setting**, and press **ENTER**.
The Device Setting screen 1/2 appears.
3. Keep pressing the ▲ or ▼ key until Device Setting 2/2 appears.

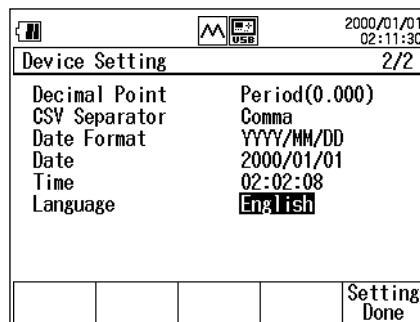

4. Use the ▲ or ▼ key to select **Language**, and press **ENTER**.
The language options are displayed.

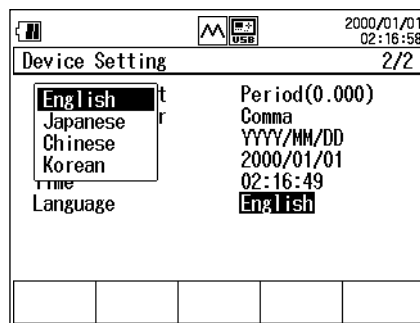

5. Use the ▲ or ▼ key to select the language, and press **ENTER**.

Confirming the Settings

6. Press **Setting Done (F5)**. The settings are confirmed.

Explanation

Language

You can set the language displayed on the screen to English, Japanese, Chinese, or Korean. The setting is retained even if you turn off the power.

6.7 Upgrading the Firmware Version of the Pressure Sensor

Operation

1. On the top menu screen, use the ▲ or ▼ key to select **Device Setting** and press the **ENTER** key.

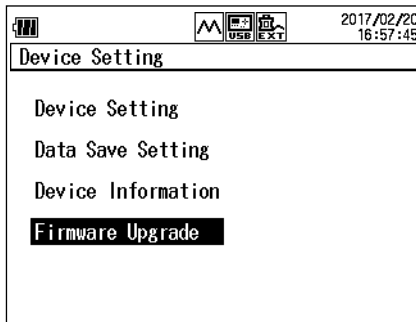

2. Use the ▲ or ▼ key to select **Firmware Upgrade** and press the **ENTER** key.

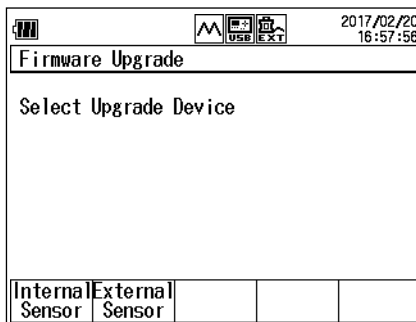

3. To upgrade the internal pressure sensor or external pressure sensor, press **Internal Sensor** (F1) or **External Sensor** (F2), respectively.
A message asking whether to upgrade the firmware version will appear.
4. To upgrade the firmware version, press the **ENTER** key. To cancel the upgrading, press the **ESC** key.
The firmware version corresponding to that of the CA700 is installed on the pressure sensor.
5. After completing the upgrading, the system displays a message prompting you to restart the CA700. Press the **ENTER** key to restart the CA700.

Explanation

The CA700 contains the firmware version of the pressure sensor that corresponds to that of this equipment. Installation of this firmware version of the pressure sensor enables upgrading the internal or external pressure sensor.

When the firmware of the CA700 has upgraded to the latest version, the firmware version of the pressure sensor contained in the CA700 is also kept up to date. You can download the latest firmware version of the CA700 from our website. For details, see our website.

When a connection is established to the pressure sensor in a firmware version earlier than the firmware version of the CA700, a message will prompt you to recommend upgrading the firmware version on the screen of the CA700.

7.1 Adjusting the Source Function

Procedure

To adjust the CA700, connect a digital multimeter to the CA700 voltage or current terminals. Use a digital multimeter with sufficient specifications to adjust the CA700.

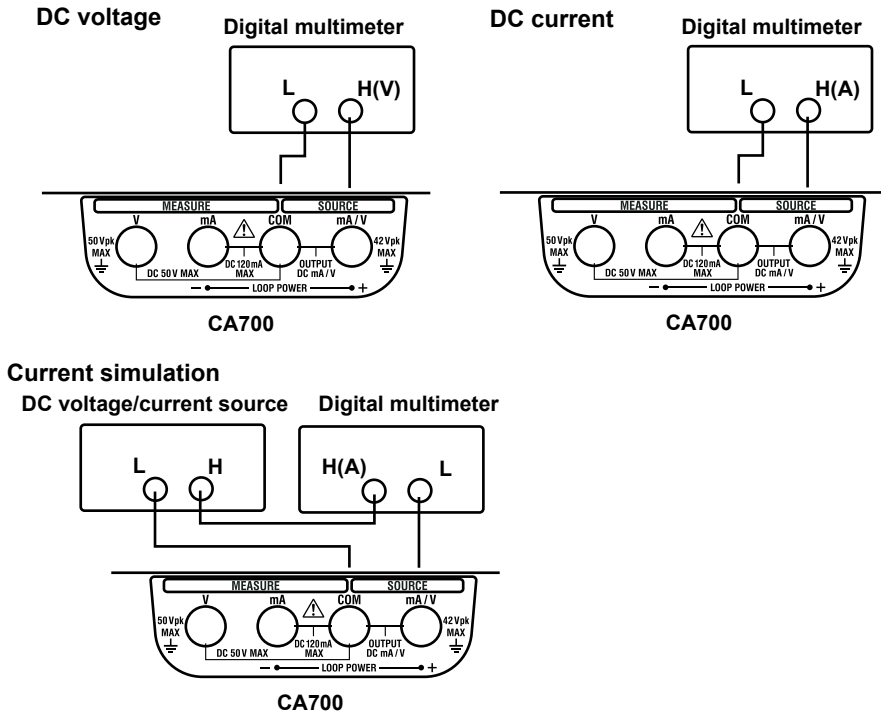

1. While holding down **HOLD** and the backlight (☀) key, turn on the CA700. Keep holding the keys down until the self-test screen appears.

The User Adjustment screen appears.

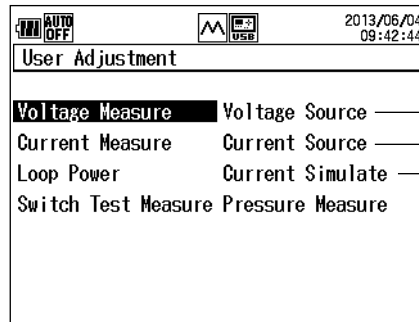

- Adjust the DC voltage source.
- Adjust the DC current source.
- Adjust the current simulation.

Adjusting the DC Voltage

- Use the ▲ or ▼ key to select **Voltage Source**, and press **ENTER**.
The DC voltage source adjustment screen appears. The CA700 generates 0 VDC.

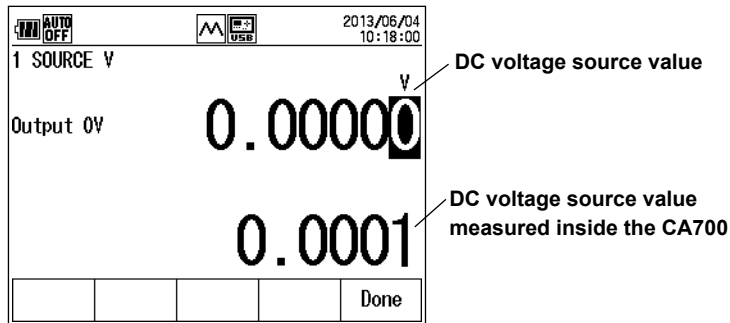

- Adjust the DC voltage at two points: 0 V and 5 V. Adjust the CA700 DC voltage source value so that it matches the reading on the digital multimeter.

Press the ◀ or ▶ key to move to the digit you want to change, press the ▲ or ▼ key to set the number. You can adjust the voltage in the range of -0.05000 V to 0.05000 V.

- Press **Done (F5)**. The 0 V source value is adjusted.
The 5 V adjustment screen appears.

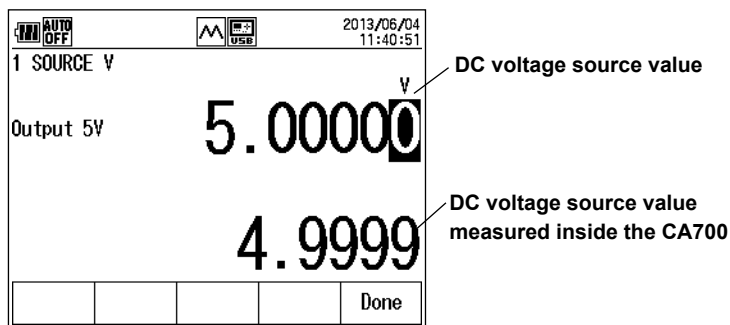

- Like step 3, adjust the 5 V source value. The adjustment range is 4.50000 V to 5.50000 V.
- Press **Done (F5)**. The 5V source value is adjusted.
The 0 V internal measurement adjustment screen appears.

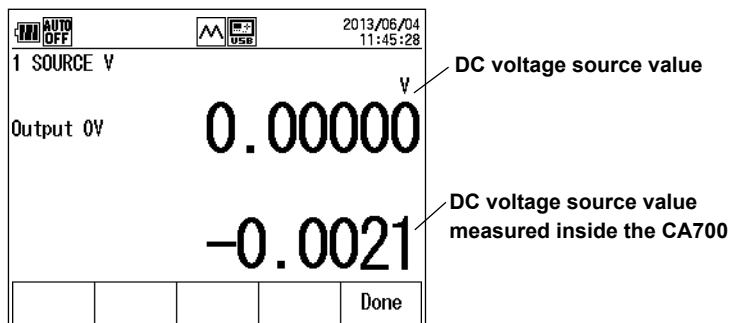

7. Press **Done (F5)**. The internal measurement of 0 V is adjusted.
The 5V internal measurement adjustment screen appears.
8. Press **Done (F5)**. The internal measurement of 5V is adjusted.
The DC voltage adjustment screen shown in step 2 appears.
9. Press **ESC**. The screen shown in step 1 appears.

Adjusting the DC Current

2. After step 1, use the ▲ or ▼ key to select **Current Source**, and press ENTER.
The DC current source adjustment screen appears. The CA700 generates 0 mA.
3. Like the adjustment of the DC voltage, adjust the source value and the internal measurement.
The adjustment points are 0 mA and 20 mA. The source adjustment ranges are –0.2000 mA to 0.2000 mA and 18.0000 mA to 22.0000 mA.

Adjusting the Current Simulation

2. After step 1, use the ▲ or ▼ key to select **Current Simulate**, and press ENTER.
The current simulation adjustment screen appears. The CA700 generates 1 mA.
3. Like the adjustment of the DC voltage, adjust the source value and the internal measurement.
The adjustment levels are 1 mA and 20 mA. The source adjustment ranges are 0.9000 mA to 1.1000 mA and 18.0000 mA to 22.0000 mA.

Finishing the Adjustment

After finishing all adjustments, press ESC several times. The top menu that normally appears when you turn the CA700 on appears.

Explanation

Adjustment Points

The ranges and adjustment points of voltage, current, and current simulation are provided below.

	Range	Adjustment Point	Adjustable Range		Notes
			Lower Limit	Upper Limit	
Voltage Source	5 V	0.00000 V	-0.05000 V	0.05000 V	Two-point calibration
		5.00000 V	4.50000 V	5.50000 V	
mA Source	20 mA	0.0000 mA	-0.2000 mA	0.2000 mA	Two-point calibration
		20.0000 mA	18.0000 mA	22.0000 mA	
mA Simulate	20 mA	1.0000 mA	0.90000 mA	1.1000 mA	Two-point calibration
		20.0000 mA	18.0000 mA	22.0000 mA	

Calibrating Internal Measurements

The CA700 has feature that measures the voltage and current that it is generating and displays the source value as “- - - - -” when the difference between the specified value and the actual source value is greater than a given value.

You must adjust the source function as well as the internal measurement function. Adjust the measurement using the source values after adjustment. In the case of voltage, the source values would be 0.00000 V and 5.0000 V.

7.2 Adjusting the Measurement Function

Procedure

To adjust the CA700, connect a DC voltage/current generator to the CA700 voltage or current measurement terminals. Use a DC voltage/current generator with sufficient specifications to adjust the CA700.

DC voltage

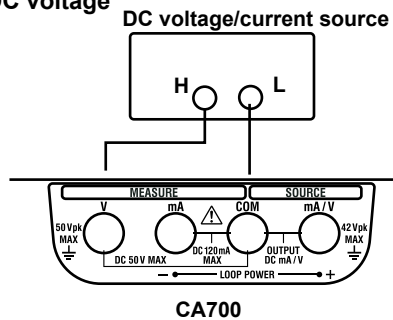

DC current

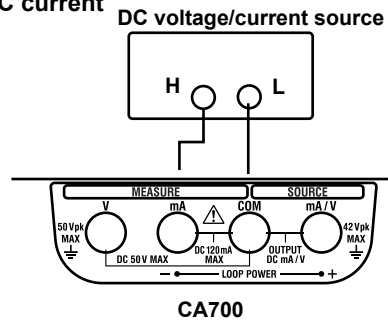

Pressure switch resistance

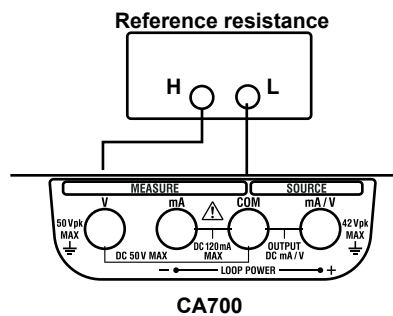

mA loop

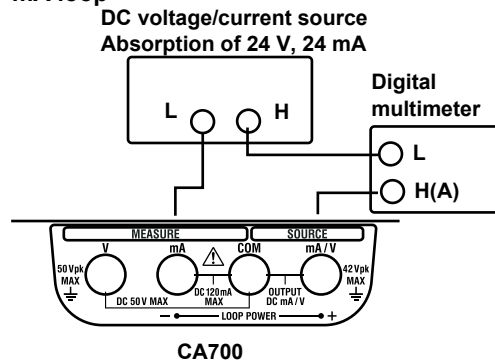

1. While holding down **HOLD** and the backlight (☀) key, turn on the CA700. Keep holding the keys down until the self-test screen appears.

The User Adjustment screen appears.

Adjust the DC current measurement.
Adjust the DC voltage measurement.

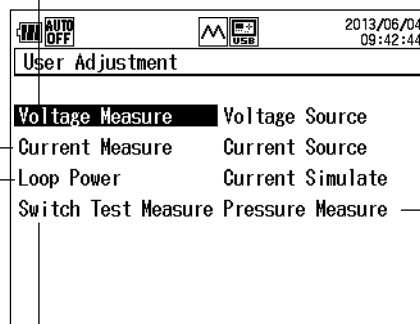

Adjust pressure measurement.
(Contact your nearest YOKOGAWA dealer or service.)

Adjust the pressure switch resistance measurement.
Adjust the loop power supply current measurement.

Adjusting the DC Voltage Measurement

- Use the ▲ or ▼ key to select **Voltage Measure**, and press **ENTER**.
The DC voltage measurement adjustment screen appears.

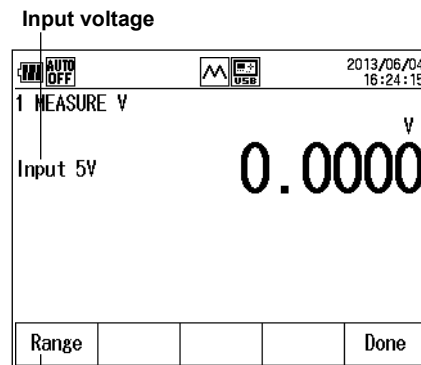

Switch the measurement range.

Adjusting the 5 V Range

- Check that Input 5V is displayed, and apply 5 VDC from the DC voltage/current generator.
- Press **Done (F5)**. The 5 V range is adjusted.

Adjusting the 50 V Range

- Press **Range (F1)** to set the measurement range to 50 V.
Input 50 V appears.
- Check that Input 50V is displayed, and apply 50 VDC from the DC voltage/current generator.
- Press **Done (F5)**. The 50V range is adjusted.

Finishing the Adjustment

- Press **ESC**. The screen shown in step 1 appears.

Adjusting the DC Current Measurement

2. After step 1, use the ▲ or ▼ key to select **Current Measure**, and press **ENTER**.

The DC current measurement adjustment screen appears.

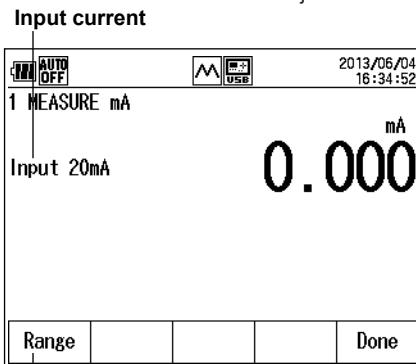

Switch the measurement range.

Adjusting the 20 mA Range

3. Check that Input 20 mA is displayed, and apply 20 mA from the DC voltage/current generator.
4. Press **Done (F5)**. The 20 mA range is adjusted.

Adjusting the 100 mA Range

5. Press **Range (F1)** to set the measurement range to 100 mA.
Input 100mA appears.
6. Check that Input 100mA is displayed, and apply 100 mA from the DC voltage/current generator.
7. Press **Done (F5)**. The 100 mA range is adjusted.

Finishing the Adjustment

8. Press **ESC**. The screen shown in step 1 appears.

Adjusting the mA Loop Measurement

- After step 1, use the ▲ or ▼ key to select **Loop Power**, and press **ENTER**.

The mA loop measurement adjustment screen appears.

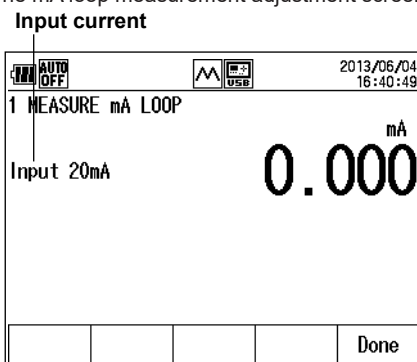

- Generate a sink current of 20 mA from the DC voltage/current generator. The CA700 will generate 24 V.
- Press **Done (F5)**. The 20mA loop measurement is adjusted.

Finishing the Adjustment

- Press **ESC**. The screen shown in step 1 appears.

Adjusting the Pressure Switch Resistance Measurement

- After step 1, use the ▲ or ▼ key to select **Switch Test Measure**, and press **ENTER**.

The pressure switch resistance measurement adjustment screen appears.

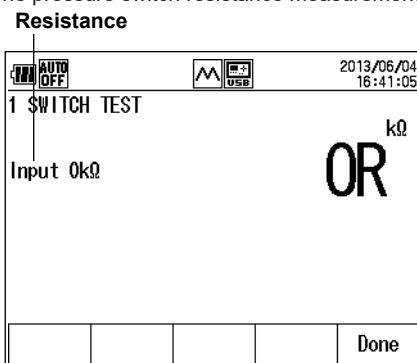

- Adjust 0 Ω. Set the reference resistance to 0 Ω.
- Press **Done (F5)**. The resistance measurement is adjusted.
- Adjust 2 kΩ. Set the reference resistance to 2 kΩ.
- Press **Done (F5)**. The resistance measurement is adjusted.

Finishing the Adjustment

- Press **ESC**. The screen shown in step 1 appears.

Explanation

Adjustment Points

The adjustment points of the measurement function are provided below.

	Range	Generator Output	Adjustable Range	
			Lower Limit	Upper Limit
Voltage Measure	5.000 V	5.0000 V	4.500 V	5.500 V
	50.00 V	50.00 V	45.00 V	55.00 V
Current Measure	20.000 mA	20.000 mA	18.000 mA	22.000 mA
	100.00 mA	100.00 mA	90.00 mA	110.00 mA
Loop Power	20.000 mA	20.000 mA	18.000 mA	22.000 mA
Switch Test Measure	0 k Ω	0 k Ω	-0.200 k Ω	0.200 k Ω
	2 k Ω	2.000 k Ω	1.800 k Ω	2.200 k Ω

Index

Symbol Page

%Span 2-4

A Page

Adjust..... 3-13
 adjusting the current simulation..... 7-3
 adjusting the DC current..... 7-3, 7-6
 adjusting the DC voltage 7-2, 7-5
 adjusting the mA loop 7-7
 adjusting the pressure switch resistance..... 7-7
 adjustment points 7-3, 7-8
 adjust the CA700
 measurement 7-4
 source 7-1
 alarm..... 1-2, 2-4, 2-7
 As Found 3-12
 As Left 3-14
 auto power-off..... 1-12, 6-1
 averaging..... 1-2, 2-2

B Page

backlight 1-12

C Page

calibration condition..... 3-4
 calibration data file..... 3-15
 calibration direction..... 3-8, 3-10
 calibration points..... 3-8, 3-10
 calibration procedure..... 1-5, 3-3
 Comm..... 5-3
 command..... 5-5
 connecting a pressure switch 3-2
 connecting a pressure transmitter 3-1
 Cont..... 2-17
 copying files..... 4-6

D Page

Data Save Setting..... 4-1
 decimal point 1-12
 decimal symbol..... 6-5
 deleting files..... 4-4
 device information 3-4, 3-17
 Device Setting 4-6, 5-2
 Direction 3-8, 3-10
 Display1 Setting..... 2-1

E Page

EXT LEAK 2-9
 EXT P 2-6

F Page

file name 1-6, 3-15, 3-20
 Firmware Upgrade..... 6-10
 Format 4-9
 formatting internal memory..... 4-9

G Page

gauge pressure..... 1-2

H Page

HART resistance 6-3
 HOLD..... 6-7
 holding displayed values 6-7
 holds the screen 1-12
 host..... 1-11, 4-8
 HYS 1-3
 hysteresis warning..... 1-3

I Page

initializing 2-5, 2-7

L Page

language..... 6-9
 LCD backlight 6-1
 LCD contrast..... 1-12, 6-1
 leak rate..... 1-2, 2-8, 2-10
 logging 1-8
 measured data 2-7
 source value..... 2-17
 Logging Interval..... 4-2
 Logging Method..... 4-1
 Logging Points 4-2
 Loop On..... 2-19, 3-12
 loop test..... 2-20
 loop voltage 2-20
 Low Level 4-9

M Page

mA loop..... 1-4
 mA LOOP 2-20
 mA MEASURE..... 2-20
 mA Simulate 2-16
 mA Source 2-16
 Mass Storage 5-3
 measure..... 2-18
 measure DC current 1-4, 2-20
 measure DC voltage..... 1-4, 2-20
 measurement conditions 2-2
 measurement function 2-20
 measurement range 2-19, 2-20
 measurement time..... 2-10
 Measure Value..... 2-5
 Min/Max..... 1-3
 MIN/MAX 6-7
 Min/Max value display 6-7
 Model No. 3-4

Index

N	Page	U	Page
Next Point	3-12	unit	2-2
number of calibration points	1-5	upgrade	6-10
Number Of Points	2-17, 3-8, 3-10	USB Connection	4-6, 5-2
		USB function	5-3
		USB interface specification	5-1
		USB port	5-1
P	Page	V	Page
PC connection	1-11	V MEASURE	2-20
percentage display	1-3, 2-4, 2-7	V Source	2-16
P LEAK	2-9		
pressure display digits	6-3	Z	Page
pressure measurement	1-2	ZERO CAL	1-2
pressure switch calibration	1-6	zero calibration	1-2
P SWITCH	3-17		
Q	Page		
Quick	4-9		
R	Page		
reference value	6-8		
RELATIVE	1-3, 6-8		
relative display	1-3, 2-5, 2-7		
Repeat Mode	2-13		
S	Page		
save	1-8		
calibration data	3-12, 3-14		
leak rate	2-10		
measured data	2-7, 2-20		
measured Data	2-7		
source value	2-12		
save method	4-3		
scaling	2-3, 2-7		
Select Proc.	3-3		
separator	1-12, 6-5		
Serial No.	3-4		
Set Point	3-12		
Setting Value	2-5		
simulation	1-3		
Single Shot	2-17		
source	1-3, 2-11		
source function	2-16		
Source On	2-12, 3-12		
source time	2-13		
status byte	5-19		
Step/Linear	2-13		
sweep			
auto	2-14		
linear	1-3, 2-17		
manual	2-15		
step	1-3, 2-17		
sweeping	1-3		
system configuration	1-1		
T	Page		
Tag No.	3-4		
Time Change	2-10		
Time Per Step	2-13		
tolerance	1-5, 3-10		
trademarks	i		
transmitter calibration	1-5		