**User's
Manual**

**YTA Series
Temperature Transmitter
(BRAIN Protocol)**

YTA SERIES

IM 01C50T03-01E

vigilantplant.™

CONTENTS

1. INTRODUCTION	1-1
■ Regarding This Manual	1-1
■ For Safe Use of Product	1-2
■ Warranty	1-2
■ ATEX Documentation	1-3
2. CONDITIONS OF COMMUNICATION LINE	2-1
2.1 Interconnection Between YTA and BT200	2-1
2.2 Communication Line Requirements	2-1
3. OPERATION	3-1
3.1 Parameters Description	3-1
3.2 Setting Parameters	3-4
3.2.1 Sensor Configuration	3-4
3.2.2 Process Variables Mapping	3-5
3.2.3 Unit Setting	3-6
3.2.4 Range Setting	3-6
3.2.5 Setting Damping Time Constant	3-6
3.2.6 Tag Number and Memo Writing	3-6
3.2.7 Forced Output Function	3-7
3.2.8 Integral Indicator Display Function	3-7
3.2.9 Burn Out Function	3-10
3.2.10 Reverse Output Function	3-10
3.2.11 Sensor Backup Function (For Model YTA320)	3-10
3.2.12 Copy the Setting Data	3-11
3.2.13 Write Protect Function	3-11
3.2.14 Sensor Trim	3-12
3.2.15 Output Trim	3-13
3.2.16 CJC Selection	3-14
4. SELF-DIAGNOSTICS	4-1
4.1 Error Message	4-1
4.2 Warning	4-3
4.3 Logging Function	4-5
4.3.1 Error Log	4-5
4.3.2 Min/Max Log	4-5
4.3.3 Operation Time	4-5
4.3.4 Power Check	4-5
4.3.5 BRAIN communication BCC error occurrence rate	4-5
5. LIST OF PARAMETERS	5-1

APPENDIX A. OPERATION OF BRAIN TERMINAL BT200.....	A-1
A.1 Operation Key Arrangement	A-1
A.2 Function of Operation Keys	A-2
A.2.1 Entry of Alphanumeric Characters	A-2
A.2.2 Function Keys	A-3
A.3 Calling of Menu Address	A-4
A.3.1 Data Display with BT200	A-5
A.3.2 Data Setting with BT200	A-5
APPENDIX B. THE SENSOR MATCHING FUNCTION.....	B-1
B.1 Specifications	B-1
B.2 Operations (The Sensor Matching Function)	B-2
APPENDIX C. SAFETY INSTRUMENTED SYSTEMS INSTALLATION	C-1
C.1 Scope and Purpose	C-1
C.2 Using the YTA for an SIS Application	C-1
C.2.1 Safety Accuracy	C-1
C.2.2 Diagnostic Response Time	C-1
C.2.3 Setup	C-1
C.2.4 Required Parameter Settings	C-1
C.2.5 Proof Testing	C-1
C.2.6 Repair and Replacement	C-2
C.2.7 Startup Time	C-2
C.2.8 Firmware Update	C-2
C.2.9 Reliability Data	C-3
C.2.10 Lifetime Limits	C-3
C.2.11 Environmental Limits	C-3
C.2.12 Application Limits	C-3
C.3 Terms and Definitions	C-3

REVISION RECORD

1. INTRODUCTION

Thank you for purchasing the YTA series Temperature Transmitter.

The YTA temperature transmitter is fully factory-tested according to the specifications indicated on your order.

This manual describes BRAIN communication functions of the model YTA110, YTA310, and YTA320 temperature transmitters and the various settings for temperature transmitter functions that can be set via the BT200 handheld terminal. The BT200 BRAIN terminal is required to change the settings of internal transmitter parameters.

In order for the YTA temperature transmitter to be fully functional and to operate in an efficient manner, read the instruction manual carefully to become familiar with the functions and operation as well as handling.

See User's Manual IM 01C00A11-01E for details related to using the BT200 BRAIN terminal. For details of mounting, wiring and maintenance of this transmitter, see the separate User's Manual IM 01C50B01-01E.

■ Regarding This Manual

- This manual should be passed on to the end user.
- The contents of this manual are subject to change without prior notice.
- All rights reserved. No part of this manual may be reproduced in any form without Yokogawa's written permission.
- Yokogawa makes no warranty of any kind with regard to this manual, including, but not limited to, implied warranty of merchantability and fitness for a particular purpose.
- If any question arises or errors are found, or if any information is missing from this manual, please inform the nearest Yokogawa sales office.
- The specifications covered by this manual are limited to those for the standard type under the specified model number break-down and do not cover custom-made instrument.
- Please note that changes in the specifications, construction, or component parts of the instrument may not immediately be reflected in this manual at the time of change, provided that postponement of revisions will not cause difficulty to the user from a functional or performance standpoint.

- The following safety symbol marks are used in this Manual:



WARNING

Indicates a potentially hazardous situation which, if not avoided, could result in death or serious injury.



CAUTION

Indicates a potentially hazardous situation which, if not avoided, may result in minor or moderate injury. It may also be used to alert against unsafe practices.



IMPORTANT

Indicates that operating the hardware or software in this manner may damage it or lead to system failure.



NOTE

Draws attention to information essential for understanding the operation and features.

■ For Safe Use of Product

For the protection and safety of the operator and the instrument or the system including the instrument, please be sure to follow the instructions on safety described in this manual when handling this instrument. In case the instrument is handled in contradiction to these instructions, Yokogawa does not guarantee safety. Please give your attention to the followings.

(a) Installation

- The instrument must be installed by an expert engineer or a skilled personnel. The procedures described about INSTALLATION are not permitted for operators.
- In case of high process temperature, care should be taken not to burn yourself because the surface of the case reaches a high temperature.
- All installation shall comply with local installation requirement and local electrical code.

(b) Wiring

- The instrument must be installed by an expert engineer or a skilled personnel. The procedures described about WIRING are not permitted for operators.
- Please confirm that voltages between the power supply and the instrument before connecting the power cables and that the cables are not powered before connecting.

(c) Maintenance

- Please do not carry out except being written to a maintenance descriptions. When these procedures are needed, please contact nearest YOKOGAWA office.
- Care should be taken to prevent the build up of drift, dust or other material on the display glass and name plate. In case of its maintenance, soft and dry cloth is used.

(d) Modification

- Yokogawa will not be liable for malfunctions or damage resulting from any modification made to this instrument by the customer.

■ Warranty

- The warranty shall cover the period noted on the quotation presented to the purchaser at the time of purchase. Problems occurred during the warranty period shall basically be repaired free of charge.
- In case of problems, the customer should contact the Yokogawa representative from which the instrument was purchased, or the nearest Yokogawa office.
- If a problem arises with this instrument, please inform us of the nature of the problem and the circumstances under which it developed, including the model specification and serial number. Any diagrams, data and other information you can include in your communication will also be helpful.
- Responsible party for repair cost for the problems shall be determined by Yokogawa based on our investigation.
- The Purchaser shall bear the responsibility for repair costs, even during the warranty period, if the malfunction is due to:
 - Improper and/or inadequate maintenance by the purchaser.
 - Failure or damage due to improper handling, use or storage which is out of design conditions.
 - Use of the product in question in a location not conforming to the standards specified by Yokogawa, or due to improper maintenance of the installation location.
 - Failure or damage due to modification or repair by any party except Yokogawa or an approved representative of Yokogawa.
 - Malfunction or damage from improper relocation of the product in question after delivery.
 - Reason of force majeure such as fires, earthquakes, storms/floods, thunder/lightening, or other natural disasters, or disturbances, riots, warfare, or radioactive contamination.

■ ATEX Documentation

This procedure is only applicable to the countries in European Union.

GB

All instruction manuals for ATEX Ex related products are available in English, German and French. Should you require Ex related instructions in your local language, you are to contact your nearest Yokogawa office or representative.

DK

Alle brugervejledninger for produkter relateret til ATEX Ex er tilgængelige på engelsk, tysk og fransk. Skulle De ønske yderligere oplysninger om håndtering af Ex produkter på eget sprog, kan De rette henvendelse herom til den nærmeste Yokogawa afdeling eller forhandler.

I

Tutti i manuali operativi di prodotti ATEX contrassegnati con Ex sono disponibili in inglese, tedesco e francese. Se si desidera ricevere i manuali operativi di prodotti Ex in lingua locale, mettersi in contatto con l'ufficio Yokogawa più vicino o con un rappresentante.

E

Todos los manuales de instrucciones para los productos antiexplosivos de ATEX están disponibles en inglés, alemán y francés. Si desea solicitar las instrucciones de estos artículos antiexplosivos en su idioma local, deberá ponerse en contacto con la oficina o el representante de Yokogawa más cercano.

NL

Alle handleidingen voor producten die te maken hebben met ATEX explosiebeveiliging (Ex) zijn verkrijgbaar in het Engels, Duits en Frans. Neem, indien u aanwijzingen op het gebied van explosiebeveiliging nodig hebt in uw eigen taal, contact op met de dichtstbijzijnde vestiging van Yokogawa of met een vertegenwoordiger.

SF

Kaikkien ATEX Ex -tyyppisten tuotteiden käyttöohjeet ovat saatavilla englannin-, saksan- ja ranskankielisinä. Mikäli tarvitsette Ex -tyyppisten tuotteiden ohjeita omalla paikallisella kielellänne, ottakaa yhteyttä lähimpään Yokogawa-toimistoon tai -edustajaan.

P

Todos os manuais de instruções referentes aos produtos Ex da ATEX estão disponíveis em Inglês, Alemão e Francês. Se necessitar de instruções na sua língua relacionadas com produtos Ex, deverá entrar em contacto com a delegação mais próxima ou com um representante da Yokogawa.

F

Tous les manuels d'instruction des produits ATEX Ex sont disponibles en langue anglaise, allemande et française. Si vous nécessitez des instructions relatives aux produits Ex dans votre langue, veuillez bien contacter votre représentant Yokogawa le plus proche.

D

Alle Betriebsanleitungen für ATEX Ex bezogene Produkte stehen in den Sprachen Englisch, Deutsch und Französisch zur Verfügung. Sollten Sie die Betriebsanleitungen für Ex-Produkte in Ihrer Landessprache benötigen, setzen Sie sich bitte mit Ihrem örtlichen Yokogawa-Vertreter in Verbindung.

S

Alla instruktionsböcker för ATEX Ex (explosionssäkra) produkter är tillgängliga på engelska, tyska och franska. Om Ni behöver instruktioner för dessa explosionssäkra produkter på annat språk, skall Ni kontakta närmaste Yokogawakontor eller representant.

GR

Όλα τα εγχειρίδια λειτουργίας των προϊόντων με ATEX Ex διατίθενται στα Αγγλικά, Γερμανικά και Γαλλικά. Σε περίπτωση που χρειάζεστε οδηγίες σχετικά με Ex στην τοπική γλώσσα παρακαλούμε επικοινωνήστε με το πλησιέστερο γραφείο της Yokogawa ή αντιπρόσωπο της.

2. CONDITIONS OF COMMUNICATION LINE

2.1 Interconnection Between YTA and BT200



WARNING

Do not attempt to use the BT200 in a dangerous environment where explosive gas or inflammable vapor is generated.

The BRAIN communication signal is superimposed onto the 4 to 20 mA DC analog signal. Since the modulated wave is a communication signal, superimposing it on the normal signal will, from basic principles, cause no error in the DC component of the analog signal. Thus, monitoring can be performed via the BT200 while the transmitter is on-line.

As shown in Figure 2.1, there are two methods of connecting the transmitter and the BT200: the first is to use the BT200 connection hook provided in the terminal box and the other is to use a terminal board or relay terminals on the transmission line.

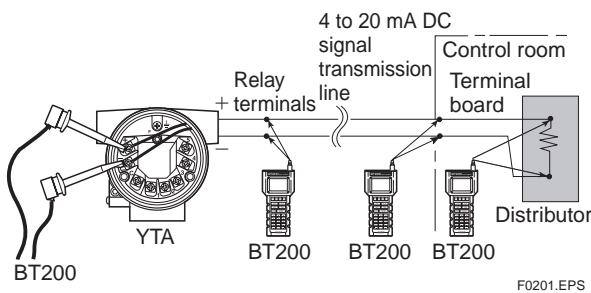

Figure 2.1 Connecting the BT200

2.2 Communication Line Requirements

Configure a loop that satisfies the following conditions for mutual communication with the temperature transmitter.

- Power supply voltage : 16.4 to 42 V DC
- Load resistance : $R + 2R_c = 250$ to 600Ω
(See Figure 2.3 for the relationship between the power supply voltage and load resistance.)
- Load capacity : 0.22 μF or less

- Load impedance : 3.3 mH or less
- Communication distance: 2 km (1.25 mile), when CEV cable is used
- Distance from the power line:
 - Output signal line : 15 cm (5.9 inch) or more
(do not use parallel wiring)
 - Input signal line : 100 cm (39.8 inch) or more
(do not use parallel wiring)
- Input impedance of receiver connected to receiving resistor: 10 k Ω more (at 2.4 kHz)

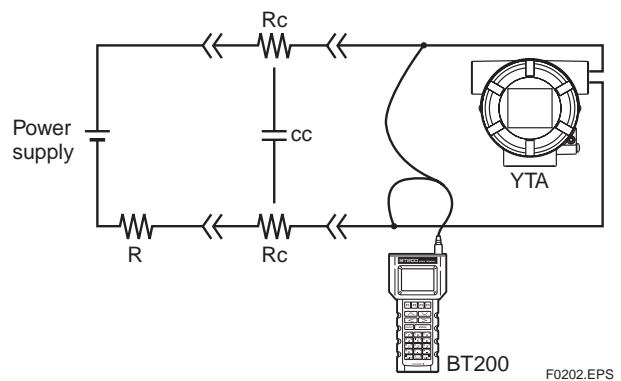

Figure 2.2 Communication line requirements

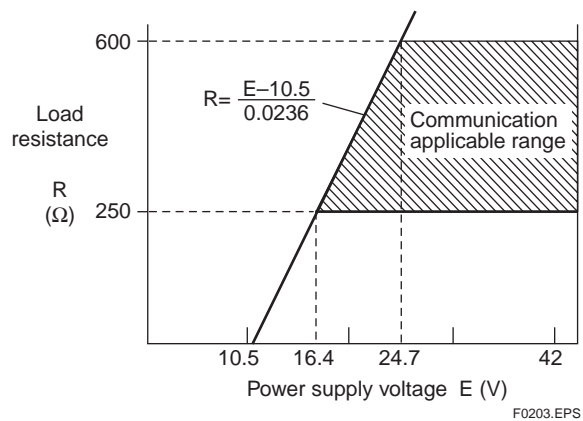

Figure 2.3 Relationship between power supply voltage and load resistance

3. OPERATION



IMPORTANT

Do not turn off the power to the transmitter immediately after setting the data using the BT200. If the transmitter is turned off less than 30 seconds after parameters have been set, the setting data will not be stored in the transmitter.

3.1 Parameters Description

The following outlines the function of the BRAIN parameters for the YTA.

- **Sensor configuration** See Page 3-4
When changing the sensor type from the current setting to another, it is necessary to change parameter settings.
D10: SENSOR1 TYPE *Sensor type setting*
D20: SENSOR1 WIRE *Wire connections setting*
E10: SENSOR2 TYPE(YTA320 only)
E20: SENSOR2 WIRE(YTA320 only)
- **Process variable mapping** See Page 3-5
Process variables can be assigned as the primary variable(PV), the secondary variable(SV), the tertiary variable(TV), and the quaternary variable(4V).
The following items can be mapped as the process variables.
Sensor1, Sensor2*2, DIFFERENCE*2, AVERAGE*2, Sensor1-Term, Sensor2-Term*2, Terminal Temp (*2: These items are displayed for the model YTA320 only.)
B10: PV is, B20: SV is, B30: TV is, B40: 4V is
- **Unit setting** See Page 3-6
Choose the engineering unit for the process variables assigned as the PV, SV, TV, and 4V from degree C and Kelvin. When mV or ohm is specified as an input type, the unit is automatically set to mV or ohm.
B11: PV UNIT, B21: SV UNIT, B31: TV UNIT, B41: 4V UNIT
- **Range setting** See Page 3-6
Changing the range of the PV as a 4 to 20mA DC output. There are two ways to set the range value.
F10: LRV, F20: URV *Setting by keypad*
F30: AUTO LRV, F35: AUTO URV
..... *Setting by applying value*
- **Damping time constant setting** See Page 3-6
Setting the response time of the transmitter smooths the output with rapid changes in input.
The damping time constant can be set between 1 and 99 seconds.
B12: PV DAMPING, B22: SV DAMPING, B32: TV DAMPING, B42: 4V DAMPING
- **Tag Number, Memo, Description and Date** See Page 3-6
C10: TAG NO. Tag number (16 characters)
O10: MEMO1, O20: MEMO2
..... *MEMO (16 characters)*
O30: DESCRIPTOR DESCRIPTION (16 characters)
O40: DATE DATE (6 characters)
- **Forced Output Function (Manual Output mode)** See Page 3-7
Setting the transmitter to output a fixed current from -2.5 to 110 % in 0.1% increments for loop checks.
G10: OUTPUT MODE, G20: OUPUT VALUE
- **Integral Indicator Display Function** See Page 3-7
The input and output values can be displayed, as can the type of temperature sensor and the number of wire connections.
M10: PROCESS DISP Process variable display selection
M20: %/mA DISP Output display selection
M30: MATRIX DISP Sensor type/wire connections display selection
M40: BAR GRAPH Output bar graph display setting
M50: DISP UPDATE Selection of a cycle speed for display
M55: Err- NO DISP Error code display
- **Burn Out Function** See Page 3-10
Configure the current output value in sensor failure. Selectable from High, Low, and User setting values.
F40: BURN OUT, F41: BURN OUT VAL, F50: TX FAILURE
- **Reverse Output Function** See Page 3-10
To reverse the direction for a 4 to 20 mA DC output relative to input.
H10: REVERSE OUT

- **Sensor Backup Function (YTA320 only)** **See Page 3-10**

Configure the transmitter to automatically transfer the input from Sensor1 to Sensor2 when Sensor1 fails.

H20: SNSR BACKUP, H21: RETURN SNS1

- **Copy the Setting Data to the BT200** **See Page 3-11**

Copy the setting data of one temperature transmitter to another via the BT200. (Uploading & Downloading)

H30: UPLOAD SELCT

- **Write Protect** **See Page 3-11**

Configure the transmitter to enable/disable write protection parameters

H40: WRITE PROTCT

- **Sensor Trim** **See Page 3-12**

Adjust the integral characterization curve stored in memory.

J05: SNSR1 CLR, J10: SNSR1 ZERO, J20: SNSR1 GAIN Sensor1 Trim

K05: SNSR2 CLR, K10: SNSR2 ZERO, K20: SNSR2 GAIN ... Sensor2 Trim (YTA320 only)

J07: IN TRIM MODE

- **Output Trim** **See Page 3-13**

Used for fine adjustment of a 4 to 20 mA DC output.

L05: OUT CLR, J10: OUTPUT MODE, J20: OUT ZERO, J30: OUT GAIN

- **Error Messages** **See Page 4-1**

To show that the transmitter has malfunctioned.

A60: SELF CHECK

- **Warnings** **See Page 4-3**

To show that incorrect settings entered for a particular usage of the transmitter.

I59: WARNING, H50: WARNING ENBL

- **Logging Function** **See Page 4-5**

Store the errors and min/max process values.

Menu tree for YTA110 & YTA310

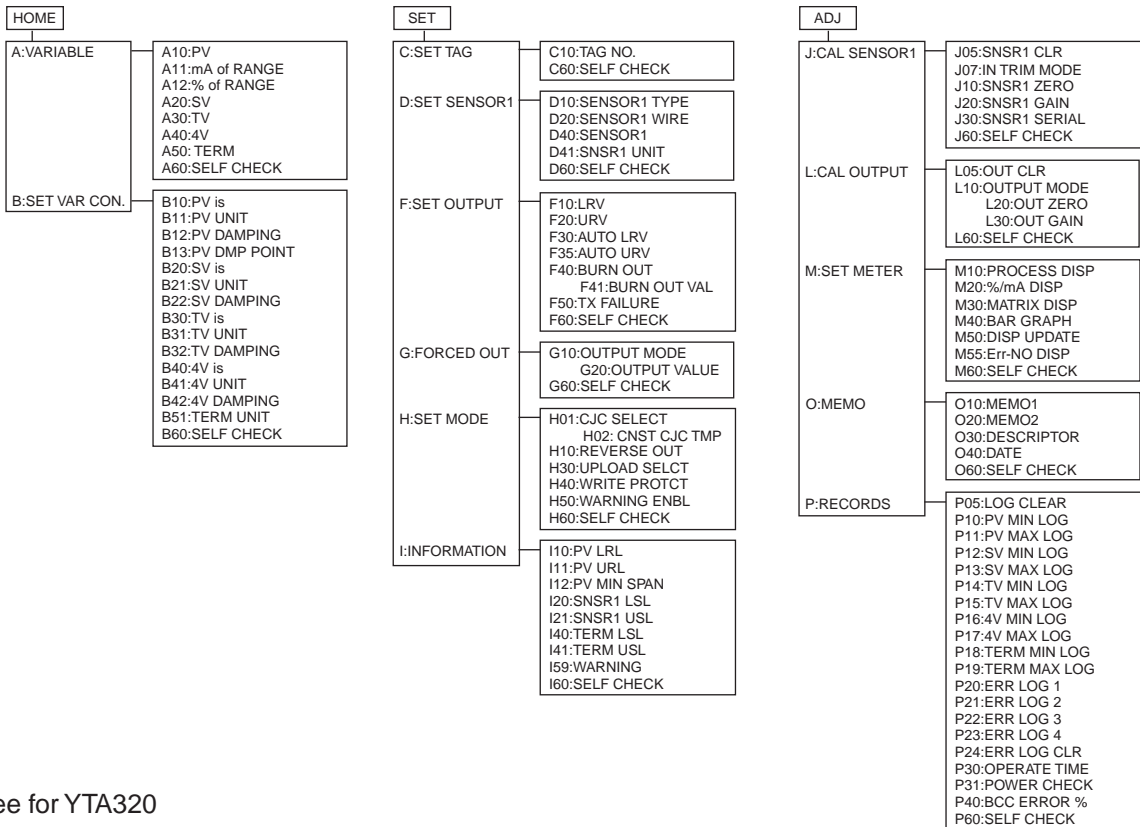

Menu tree for YTA320

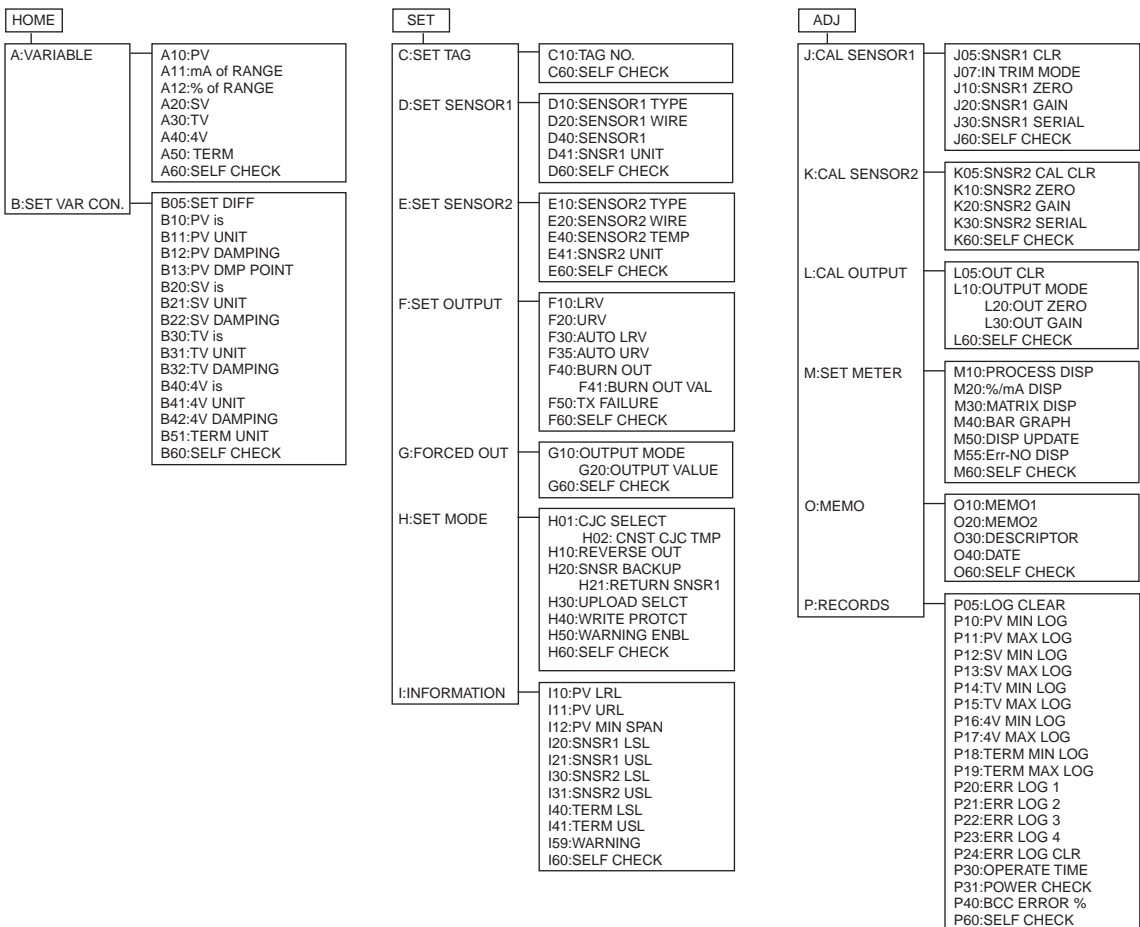

F0300.EPS

3.2 Setting Parameters

3.2.1 Sensor Configuration

When the sensor type or the number of wire connections changes, the following parameters must be reset.

Sensor type setting;

D10: SENSOR1 TYPE, E10: SENSOR2 TYPE

Wire connections setting;

D20: SENSOR1 WIRE, E20: SENSOR2 WIRE

Figure 3.1 diagram shows the wire connections to the input terminals of the transmitter and sensor type selections for the parameters in each connection case. Note that TCs and mV are categorized as Group A and RTDs and ohm as Group B.

Check the connections between the input terminals and temperature sensors and set the correct sensor type and the number of wire connections for the parameters.

Sensor type selection

Thermocouple TYPE W3, W5 (ASTM988)
TYPE B, E, J, K, N, R, S, T (IEC 584)
TYPE L, U (DIN 43710)

Resistance thermometer

Pt100, Pt200, Pt500 (IEC 751)

[2-, 3- or 4-wire]

JPt100 (JIS)
Ni120 (STI INC), Cu (SAMA RC21-4)

DC voltage

mV

Resistance

ohm [2- or 3-wire]

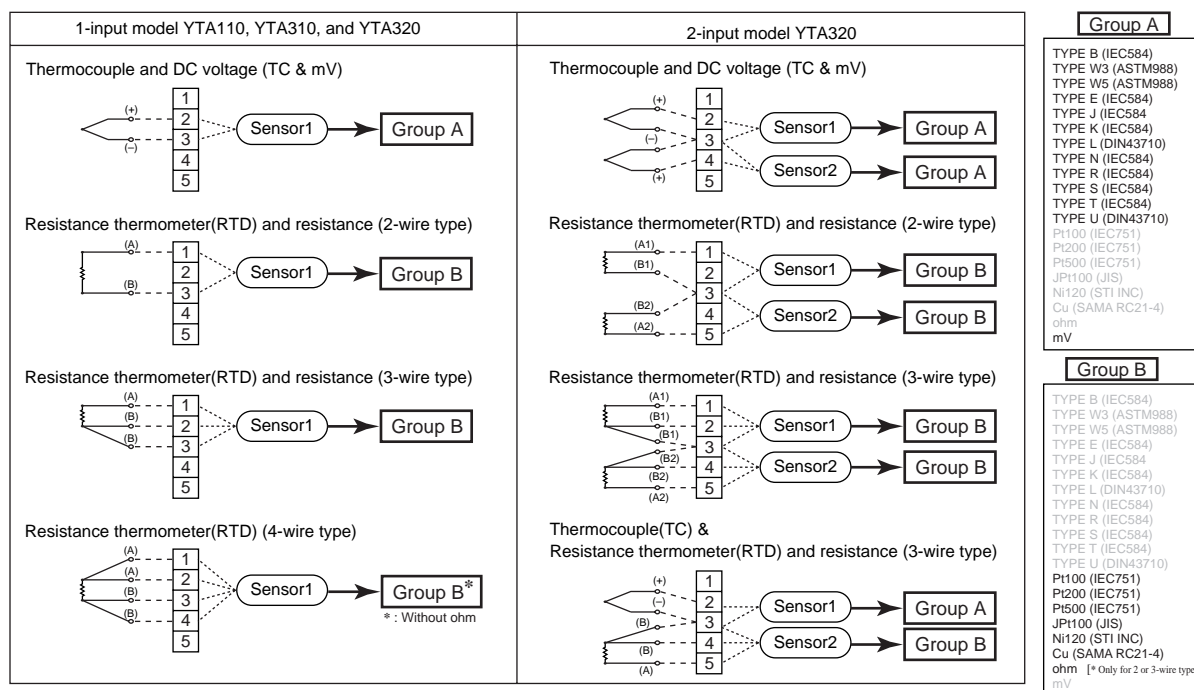

F0301.EPS

Figure 3.1 Input terminal wire connection diagram and sensor type categories

● Example: Set Pt 100 and 4-wire type to Sensor1. (model YTA320)

<1>

```
PARAM
D10:SENSOR1 TYPE
Pt200 (IEC751)
D20:SENSOR WIRE
3 WIRE
D40:SENSOR1 TEMP
23.56 degC
DATA DIAG PRNT ESC
```

1. Select D: SET SENSOR1 to go to the screen (1).

2. Select "D10" and press [ENTER] to go to the screen (2).

<2>

```
SET
D10:SENSOR1 TYPE
Pt200 (IEC751)
Pt100 (IEC751) >
<Pt200 (IEC751) >
<Pt500 (IEC751) >
<JPt100 (JIS) >
ESC
```

3. Select "Pt100" and press [ENTER] twice.

4. Check that "Pt100" has been set and press [OK].

<3>

```
SET
D20:SENSOR1 WIRE
3 WIRE
<3 WIRE >
<4 WIRE >
<2 WIRE >
ESC
```

5. To set the number of wire connections, select D20 and press [ENTER].

6. Select "4 WIRE" and press [ENTER] twice.

7. Press [OK].

```
TYPE B (IEC584)
TYPE W3 (ASTM988)
TYPE W5 (ASTM988)
TYPE E (IEC584)
TYPE J (IEC584)
TYPE K (IEC584)
TYPE L (DIN43710)
TYPE N (IEC584)
TYPE R (IEC584)
TYPE S (IEC584)
TYPE T (IEC584)
TYPE U (DIN43710)
Pt100 (IEC751)
Pt200 (IEC751)
Pt500 (IEC751)
JPt100 (JIS)
Ni120 (STI INC)
Cu (SAMA RC21-4)
ohm
mV
Non Connection
```

Note: D40 indicates input values of the sensor based on the settings at D10 and D20.

F0302.EPS

3.2.2 Process Variables Mapping

Process variable mapping;

B10: PV is, B20: SV is, B30: TV is, B40: 4V is

Process variables can be assigned as the primary variable(PV), the secondary variable(SV), the tertiary variable(TV), and the quaternary variable(4V). The PV always outputs a 4 to 20mA DC analog signal corresponding to Lower Range Value and Upper Range Value. Mapping process variables to the SV, TV, and 4V is optional.

The following items can be mapped as the process variables.

- Sensor1 : Sensor1 input value.
- Sensor2 : Sensor2 input value.
- DIFFERENCE ^{*1,*2,*4} : Difference between Sensor1 and Sensor2. (Sensor1-Sensor2 or Sensor2-Sensor1; specified in B05: SET DIFF)

- AVERAGE ^{*1,*4} : Average of Sensor1 and Sensor2. [(Sensor1 + Sensor2)/2]
- Sensor1-Term ^{*4,*5} : Difference between Sensor1 and terminal temperature
- Sensor2-Term ^{*1,*4,*5} : Difference between Sensor2 and terminal temperature
- Terminal Temp : Terminal temperature
- Not used ^{*3} : Showing that a process variable is not assigned.

- *1: This item is displayed only when the YTA320 2-input temperature transmitter is used.
- *2: The setting in B05 applies to the PV, SV, TV, and 4V.
- *3: "Not used" is not displayed for B10 since the PV requires process variable mapping.
- *4: When this item is selected, the sensor types to be set for D10(Sensor1) and E10(Sensor2) should be selected from any one of the following three groups; Temperature sensor(T/C and RTD), DC voltage or resistance. The combination(for example, temperature sensor and DC voltage input) would cause an incorrect computation due to the different unit system and is not allowed.
- *5: When this item is selected, DC voltage and resistance input should not be set for D10(Sensor1) or E10(Sensor2).

● Example: Use two temperature sensors to map the difference (Sensor2-Sensor1) between Sensor1 and Sensor2 to the PV (the primary variable). Before mapping the process variable, complete the setting of the temperature sensor to be connected to Sensor1 and Sensor2.

Sensor1 setting: D10: SENSOR1 TYPE, D20: SENSOR1 WIRE
Sensor2 setting: E10: SENSOR2 TYPE, E20: SENSOR2 WIRE

```
PARAM
B05:SET DIFF
Sensor1-Sensor2
B10:PV is
Sensor1
B11:PV UNIT
degC
DATA DIAG PRNT ESC
```

1. Set the content of "DIFFERENCE" for the difference between Sensor1 and Sensor2. Select B05: SET DIFF and press [ENTER]

```
SET
B05:SET DIFF
Sensor1-Sensor2
<Sensor1-Sensor2 >
<Sensor2-Sensor1 >
ESC
```

2. Select "Sensor2 - Sensor1" and press [ENTER] twice.
3. Press [OK].

```
SET
B10:PV is
Sensor1
<Sensor1 >
<Sensor2 >
<DIFFERENCE >
<AVERAGE >
ESC
```

4. Select B10: PV is and press [ENTER] for PV mapping.
5. Select "DIFFERENCE" and press [ENTER] twice.
6. Press [OK].

If the temperature sensor is correctly connected to Sensor1 and Sensor2, the setting content is reflected on A10: PV.

F0303.EPS

3.2.3 Unit Setting

B11: PV UNIT, B21: SV UNIT, B31: TV UNIT, B41: 4V UNIT

Select the engineering unit for the process variables assigned as PV, SV, TV, and 4V from degree C, Kelvin, degree F* and degree R*. When mV or ohm is specified as an input type, the unit is automatically set to mV or ohms.

*: Degree F and degree R are available only when optional code /D2 is specified.

3.2.4 Range Setting

(a) Changing the range with keypad

Lower range value setting;

F10: LRV, Upper range value setting; F20: URV

The range for the PV corresponding to the 4 to 20mA output signal is set at the factory before shipment. The procedure to rerange is as follows.

● Example: Changing the measurement range from 0 to 100°C to 0 to 150°C .

PARAM
F10:LRV 0 degC

F20:URV 100 degC

F30:AUTO LRV
DISABLE

DATA DIAG PRNT ESC

1. Select F20: URV and press [ENTER].

PARAM
F20:URV 0 degC

+ 150

DEL CLR ESC

2. Input "150" and press [ENTER] twice.

3. Press [OK].

Note : The unit selected in B11: PV UNIT is applied to the units used for F10 and F20.

F0304.EPS



NOTE

When entering numeric values at the range setting, the value of URV must be greater than that of LRV.
Range Setting Condition: URV > LRV

(b) Changing the range while applying an actual input

F30: AUTO LRV

F35: AUTO URV

This feature allows the lower and upper range values to be setup automatically with the actual input applied.

3.2.5 Setting Damping Time Constant

B12: PV DAMPING, B22: SV DAMPING,

B32: TV DAMPING, B42: 4V DAMPING

Setting the response time of each Process Variable to make the output change very slowly with a rapid change in input. Set the value from 0 to 99 seconds.

If the time constant is set to 2 seconds, the transmitter calculates a reading every cycle using the damping equation, in order to make the output 63 percent of the input range after 2 seconds.

This damping time constant is normally set to work when the temperature make a step change within 2 percent of the output range. The damping can be changed using the "B13: PV DMP POINT" parameter.

● Setting Damping Holding Point

B13: PV DMP POINT

This parameter is used to set the point where the transmitter conducts the PV damping operation, depending on a magnitude of the change in the input value. When the change value in percent exceeds the setting value, the transmitter outputs the signal without the damping operation. Set the value as a percent of span.

● Example: Output pattern for the setting value of 10%

•Change value less then 10%

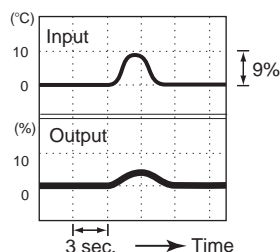

Assumed setting
Renge: 0 to 100 °C
Damping time: 3 sec.

•Change value 10% or above

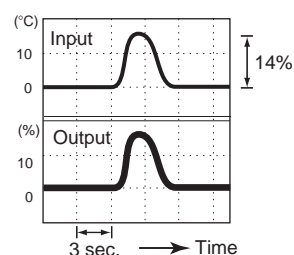

F0325.EPS

3.2.6 Tag Number and Memo Writing

Tag number (See Appendix A. Section A.3.2)

C10: TAG NO.

Up to sixteen alphanumeric characters can be entered. The tag number is as specified upon shipment.

Memo**O10: MEMO1, O20: MEMO2**

Up to sixteen alphanumeric characters can be entered.

Description**O30: DESCRIPTOR**

Up to sixteen alphanumeric characters can be entered.

Date**O40: DATE**

Six numeric values can be entered. Only a date recording function is provided; no internal clock function is provided, thus the date is not updated.

3.2.7 Forced Output Function**G10: OUTPUT MODE, G20: OUTPUT VALUE**

This feature can be used to output a fixed current from 3.6 mA (-2.5%) to 21.6 mA (110%) for loop checks.

● Example: Outputting 16 mA (75%) constant current

1. Select G10: OUTPUT MODE and press [ENTER].
2. Set "MANUAL MODE mA."
3. G20: OUTPUT VALUE is displayed. Select G20: OUTPUT VALUE and press [ENTER].
4. Set "16."
5. Pressing [ENTER] twice outputs a constant current. If the transmitter is equipped with the integral indicator, the LCD displays F.O.
6. Press [OK].

"F.O." lit on.

F0305.EPS

**IMPORTANT**

- Manual mode output is held for approximately 10 minutes and then released automatically after the time has elapsed. Even if the BT200 power supply is turned off or the communication connector is disconnected during the test, it is held for approximately 10 minutes.
- To release the test output immediately, set "AUTOMATIC MODE" at G10 as seen in the figure above or turn off the transmitter.

3.2.8 Integral Indicator Display Function

If the transmitter is equipped with the integral indicator, the following items can be displayed in parameter settings.

(a) Display process variable**M10: PROCESS DISP**

Displays PV value.

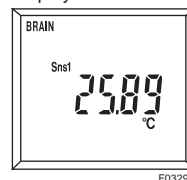

F03291

Used to select the process variable to be displayed on the LCD indicator. If more than one process is selected, they are displayed in sequence as the display update cycles. The appropriate unit is also displayed for each process variable.

Also, if the output value is selected at M20, the process variable and output value are displayed alternately.

PV	: Displays PV value
SV	: Displays SV value
TV	: Displays TV value
4V	: Displays 4V value
PV, SV	: Displays PV and SV value alternately
PV, SV, TV	: Displays PV, SV and TV value alternately
PV, SV, TV, 4V	: Displays PV, SV, TV, and 4V value alternately
INHIBIT	: The process variable is not displayed.

(b) Display output value**M20: %/mA DISP**

Displays output value.

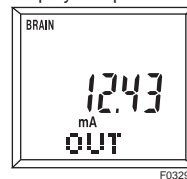

F03292

Used to select the output indications to be displayed on the LCD indicator. If two output indications are selected, they are displayed in sequence as the display update cycles.

mA	: Displays output value in mA
%	: Displays output value in %
mA, %	: Displays output value in mA and % alternately
INHIBIT	: The output value is not displayed

FAST	: 1/2 of the normal cycle speed
NORMAL	: Normal cycle speed
SLOW	: 1.5 times of the normal cycle speed

**NOTE**

When operating under -10°C (14°F), the display response time may be reduced. In such a case, set the display cycle speed to "NORMAL" or "SLOW."

(c) Display sensor type/number of wire connections**M30: MATRIX DISP**

Displays PV value and sensor type

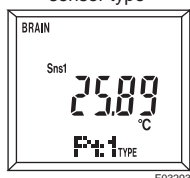

Used to select the input sensor type and the number of wire connections to be displayed on the LCD indicator. The displays of these items are synchronized with the process variable displays selected at M10. Specifying "INHIBIT"

under M10 disables the function of M30 for the display.

PROCESS	: Displays process variables (PV, SV, TV, or 4V.)
TYPE	: Displays sensor type
WIRE	: Displays number of wire connections
PROCESS, TYPE	: Displays process and sensor type alternately
TYPE, WIRE	: Displays sensor type and number of wire connections alternately
INHIBIT	: the sensor type and the number of wire connections is not displayed

(d) Display output bar graph**M40: BAR GRAPH**

Displays bar graph.

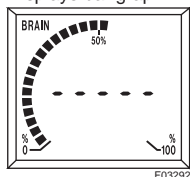

Used to select output bar graph display ON/OFF.

SHOW	: Displays analog output bar graph
INHIBIT	: No bar graph display

(e) Select a cycle speed for display**M50: DISP UPDATE**

Used to select the update rate for the display on the LCD indicator. Process variables, output values, and error codes are displayed using this cycle speed.

(f) Display error code

M55: Err-NO DISP

If an error occurs, the error code is displayed on the LCD indicator.

- SHOW : Error code is displayed
- INHIBIT : Error code is not displayed

● Example of LCD display cycle

The example of the LCD indicator is based on the following settings.

Integral indicator display parameter setting	Assumed current status and parameter settings
M10: PROCESS DISP = PV, SV	A10: PV = 50.0 degC
M20: %/mA DISP = mA	A11: mA of RANGE = 12.00 mA
M30: MATRIX DISP = PROCESS, TYPE	A20: SV = 25.16 degC
M40: BAR GRAPH = SHOW	B10: PV is = Sensor1
	B20: SV is = Sensor1-Term
	D10: SENSOR1 TYPE = TYPE B

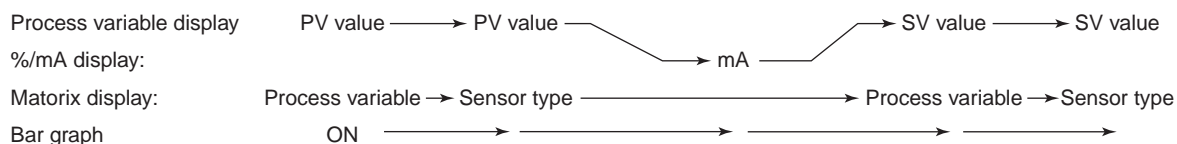
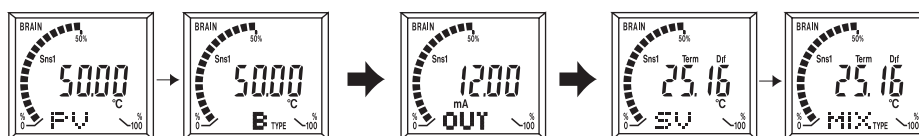

F0306.EPS

3.2.9 Burn Out Function

(a) Sensor burn out

Configure the burn out mode in the case of sensor failure or disconnection. When the sensor failure is detected, the transmitter will output one of the following values.

F40: BURN OUT

Select from the followings:

- LOW : Outputs 3.6 mA (-2.5%)
- HIGH : Outputs 21.6 mA (110%)
- USER mA : Output user set value in mA.
Settable 3.6 to 21.6 mA in F41
- USER % : Output user set value in %.
Settable -2.5 to 110 % in F41
- OFF : The burn out output is NOT defined

F41: BURN OUT VAL

When "USER mA" or "USER %" is selected at F40:BURN OUT, F41:BURN OUT VAL is displayed. The output value setting range is 3.6 to 21.6 mA (-2.5 to 110%).

● Example: Setting output to 20.8 mA in the event of sensor burn out

<pre>PARAM F40:BURN OUT HIGH F50:TX FAILURE HIGH F60:SELF CHECK GOOD DATA DIAG PRNT ESC</pre>	<p>1. Select F40: BURN OUT and press [ENTER].</p>
<pre>SET F40:BURN OUT HIGH <HIGH > <USER mA > <USER % > <OFF > ESC</pre>	<p>2. Select "USER mA" and press [ENTER] twice. 3. Press [OK].</p>
<pre>PARAM F40:BURN OUT USER mA F41:BURN OUT VAL 21.6 mA F50:TX FAILURE HIGH DATA DIAG PRNT ESC</pre>	<p>4. Select F40: BURN OUT VAL and press [ENTER].</p>
<pre>SET F41:BURN OUT VAL 21.6 mA + 20.8 DEL CLR ESC</pre>	<p>5. Set "20.8" and press [ENTER] twice. 6. Press [OK].</p>

F0307.EPS

During sensor burn out time, the Sensor1 failure or the Sensor2 failure error message is generated. (See Section 4.1.1 for details.)

If the transmitter is equipped with the integral indicator, the LCD displays "Abn." and "OUT" as shown in Figure 3.2.

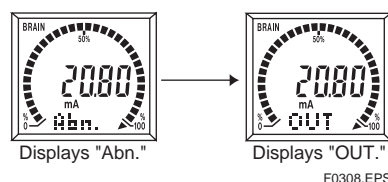

Figure 3.2 Integral Indicator Display in Sensor Burn Out

(b) Confirming the output direction if Hardware error occurs

F50: TX FAILURE

The output status of the transmitter in hardware failure is set by using a jumper on the CPU assembly. (See IM 01C50B01-01E section 3.2) The current setting can be checked in parameter D50: TX FAILURE.

- HIGH : When an error occurs, 110%(21.6mA) or higher is output.
- LOW : When an error occurs, -5%(3.2mA) or lower is output.

3.2.10 Reverse Output Function

H10: REVERSE OUT

To reverse the direction for a 4 to 20 mA DC output relative to input.

3.2.11 Sensor Backup Function (For Model YTA320)



IMPORTANT

To use sensor backup function, the following conditions must be met.

- "Sensor1" is mapped as the PV at B10: PV is.
- "Sensor2" is mapped as the SV at B20: SV is.
- "Sensor1" and "Sensor2" are both correct input status.
- "HIGH, LOW, User mA, or User %" is selected in the sensor burnout parameter setting at F40: BURN OUT

The sensor backup command sets the transmitter to automatically use Sensor2 as PV if Sensor1 fails. When the transmitter is in the Sensor Backup operation and switches to Sensor2, there will be no disruption in the 4 to 20 mA output. The error code for Sensor1 failure is shown on the integral indicator, and also the error message is sent to the BT200 that the Sensor1 failed and the sensor backup has been in operation. In case Sensor2 fails during the backup operation, the

transmitter will send the error code for Sensor2 failure to the integral indicator and the BT200, and outputs the "Sensor burnout" value.

(a) Setting of backup mode

H20: SNSR BACKUP

Set "ENABLE" at H20: SNSR BACKUP.

- ENABLE : Activates backup mode, and transmitter starts to observe.
- DISABLE : Cancels backup mode.



IMPORTANT

Do not change the PV and SV mapping data when the sensor backup mode is active. Cancel the sensor backup mode to alter the mapping data.

(b) Returning from Sensor2 to Sensor1 during the sensor backup operation

H21: RETURN SNS1

Once the transmitter enters the sensor backup operation, H21:RETURN SNS1 appears on the BT200. This parameter is used to retrieve the output to the Sensor1 input value. Ensure that Sensor1 and Sensor2 are both correct input status, then;

Set "ENABLE" at H21:RETURN SNS1.

- ENABLE : Switches to Sensor1 output.
- DISABLE : Maintains Sensor2 output status.



IMPORTANT

In the sensor backup operation, even if the Sensor1 recovers, the Sensor2 input value continues to be output until "ENABLE" is set at H21: RETURN SNS1 or the transmitter's power is turned off and then on again.

3.2.12 Copy the Setting Data

H30: UPLOAD SELCT

This function is used to copy the setting data of one temperature transmitter to another.

Connect the temperature transmitter with the BT200 and record (UPLOAD) the setting data to the BT200 nonvolatile memory. By connecting the BT200 to other temperature transmitters, recorded data can be overwritten (DOWNLOAD) on the transmitters.

The YTA series temperature transmitter handles the uploading data at two levels. It is necessary to specify the desired one before uploading data.

SET PRAM ONLY : Uploads the parameters with respect to the operation settings such as LRV and the sensor type.

ALL PRAM : Uploads the all parameters.

See the parameter list at the end of this manual for classification of the operation setting parameter groups and the parameter group unique to the equipment. See also the BT200 instruction manual, IM 1C0A11-01E, for the setting procedure.

3.2.13 Write Protect Function

(a) Software Write Protect Function

H40: WRITE PROTCT

The write protect function is used to prevent unauthorized configuration data changes in the transmitter.

- YES : Disables writing of all parameters other than H40.
- NO : Enables writing of all parameters.

If the transmitter is equipped with the integral indicator, the LCD displays "W.P." when setting H40 to YES.

● Example: Setting write protect on

```

SET
H40:WRIT PROTCT
NO
<NO >
<YES >
ESC
          
```

1. Select "YES" and press [ENTER] twice to enter the setting.

"W. P." lit on

F0309.EPS

(b) Hardware Write Protect Function

Hardware write protect function is set up by Switch (SW2) on the CPU assembly. Under write protect status, any change operation is denied. If the transmitter is equipped with the integral indicator, the LCD displays "W.P." when setting SW2 to "Y".

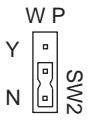
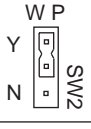
Pin position of SW2	Write Protect Status
	No
	Yes

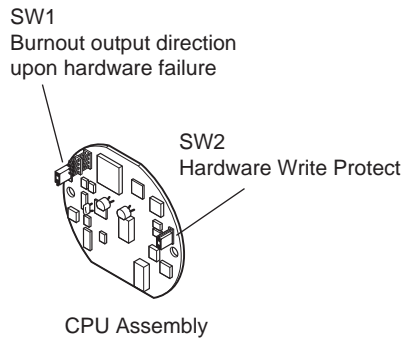

F0355.EPS

Figure 3.3 SW2 setting

3.2.14 Sensor Trim

Each YTA transmitter is factory-characterized based on the standard sensor curve and uses the information to produce a process variable output. The sensor trim function is used to adjust to the transmitters internal interpretation of the input signal.

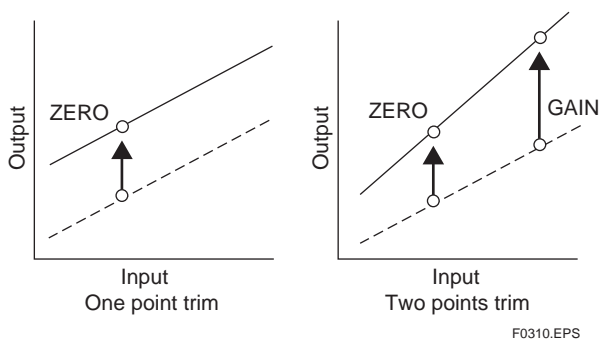

Figure 3.4 Trim function images

(a) Zero/Gain Point Adjustment

J07: IN TRIM MODE

J10: SNSR1 ZERO, J20: SNSR1 GAIN

K10: SNSR2 ZERO, K20: SNSR2 GAIN ...YTA320 only

- 1) Connect the temperature transmitter and the calibration device as shown in Figure 3.5 and warm up for at least three minutes.

a. Wiring of power supply and output

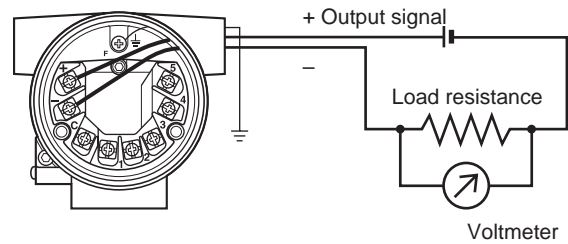

b. Example of wiring of thermocouple or DC voltage input (1-input type)

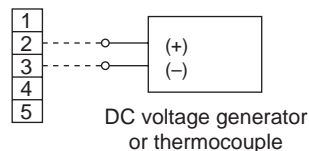

c. Example of wiring of thermometer resistor 4-wire type (1-input type)

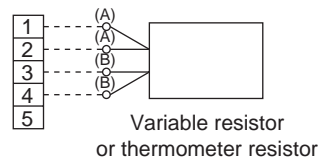

F0311.EPS

Figure 3.5 Example of wiring for calibration equipment

- 2) Check the sensor type with the D: parameter.
- 3) Select the input trimming mode in J07:IN TRIM MODE. The following selections are offered.
 - V.R./ZERO&GAIN
 - V.R./ZERO
 - TEMP/ZERO&GAIN
 - TEMP/ZERO
 Select “V.R./ZERO&GAIN” or “V.R./ZERO” when the calibration device is DC voltage generator or Variable resistor, or select “TEMP/ZERO&GAIN” or “TEMP/ZERO” when the device is Temperature sensor.
- 4) Perform zero-point adjustment.
 - When the input trimming mode is “V.R./ZERO&GAIN” or “V.R./ZERO”, apply the value for the zero-point shown in the Table 3.1 depending on the specified sensor type. Wait until the input from the calibration device becomes stable.
 - When the input trimming mode is “TEMP/ZERO&GAIN” or “TEMP/ZERO”, expose the temperature sensor to calibration temperature for the zero-point. Wait until the input from the temperature sensor becomes stable.

Table 3.1 Zero and Gain point value for Sensor trim

Sensor type		Setting value	
		Zero-point	Gain-point
TC	B,R,S,T	+0[mV]	+25[mV]
	E,J,K,N,W3,W5,L,U, mV	+0[mV]	+75[mV]
RTD	Pt100,JPt100,NI120,Cu	+40[ohm]	+330[ohm]
	Pt200, Pt500, ohm	+40[ohm]	+1600[ohm]

T0301.EPS

- 5) Enter the current input value in J10: SNSR1 ZERO (or K10: SNSR2 ZERO for YTA320).
- 6) Press [ENTER] twice and press [OK].
- 7) Perform gain-point adjustment if “V.R./ZERO&GAIN” or “TEMP/ZERO&GAIN” is selected in J07:IN TRIM MODE.
 - When the input trimming mode is “V.R./ZERO&GAIN” apply the value for the gain-point shown in the Table 3.1 depending on the specified sensor type. Wait until the input from the calibration device becomes stable.
 - When the input trimming mode is “TEMP/ZERO&GAIN”, expose the temperature sensor to calibration temperature for the gain-point. Wait until the input from the temperature sensor becomes stable.
- 8) Enter the current input value in J20: SNSR1 GAIN (or K20: SNSR2 GAIN for YTA320).
- 9) Press [ENTER] twice and press [OK].

**NOTE**

- First correct the ZERO point, then correct the GAIN point in two points calibration. When the GAIN point is adjusted, the ZERO point correction amount is also updated and written into the EEPROM.
- The calibration unit is changed to “mV” or “ohm” depending on the type of connected sensor when the input trimming mode is “V.R./ZERO&GAIN” or “V.R./ZERO” or to temperature unit selected at D41:SNSR1 UNIT.

(b) Returning to the factory set value**J05: SNSR1 CLR****K05: SNSR2 CLR ...YTA320 only**

To return to the factory set value, set “USER CAL CLEAR” or “USER CAL IGNORE” at J05: SNSR1 CLR for the Sensor1 and K05: SNSR2 CLR for the Sensor2.

USER CAL CLEAR : Clear user trim value and return to the factory set value.

USER CAL IGNORE : Ignore user trim value and return to the factory set value.

USER CAL ACT : Use user trim value.

**NOTE**

Regardless of restarting the transmitter, the “USER CAL ACT” is always set and the user trim value is used as the input signal unless it is cleared by “USER CAL CLEAR.”

3.2.15 Output Trim**(a) Zero/Gain Point Adjustment****L10: OUTPUT MODE, L20: OUT ZERO, L30: OUT GAIN**

The output adjustment function can match the 4 mA and 20 mA output of the temperature transmitter to the reference meter such as a voltmeter.

- 1) Connect the temperature transmitter, 250 Ω resistance and the voltmeter as shown in Figure 3.2.
- 2) Select L10: OUTPUT MODE and press [OK].
- 3) Select “MANUAL MODE 4mA” and press [ENTER] twice.
(4 mA output status continues for 10 minutes.)
Press [OK].
- 4) Select L20: OUT ZERO and press [OK].
- 5) Write the indicated value of the voltmeter to L20: OUT ZERO and press [ENTER] twice.
(The temperature transmitter automatically corrects the difference between this value and the operation output.)
Press [OK].
- 6) Select L10: OUTPUT MODE and press [OK].
- 7) Select “MANUAL MODE 20mA” and press [ENTER] twice.
(20 mA output status continues for 10 minutes.)
Press [OK].
- 8) Write the indicated value of the voltmeter at L30: OUT GAIN and Press [ENTER] twice.
(The temperature transmitter automatically corrects the difference between this value and the operation output.) Press [OK].

Note 1: First correct the ZERO point, then correct the GAIN point. If the ZERO point is not adjusted, GAIN point is not corrected.

(b) Returning to the factory set value**L05: OUT CLR**

To return to the factory set value;

USER CAL CLEAR : Clear user trim value and return to the factory set value.

USER CAL IGNORE : Ignore user trim value
and return to the
factory set value.
USER CAL ACT : Use user trim value.

**NOTE**

Regardless of restarting the transmitter, the “USER CAL ACT” is always set and the user trim value is used as the input signal unless it is cleared by “USER CAL CLEAR.”

3.2.16 CJC Selection

For thermocouple input, terminal temperature measured by an internal sensor is used for Cold Junction Compensation function. In YTA, a constant value set by users can be used for the compensation function in place of the terminal temperature. If the constant value is set to “0”, the compensation is not applied.

H01 : CJC SELECT

Select “Constant CJC” to use the constant value in place of terminal temperature;

INTERNAL CJC : Use the terminal temperature measured by an internal sensor.
CONSTANT CJC : Use the constant value set by users.

H02 : CNST CJC TMP

This parameter appears only when “CONSTANT CJC” is selected for H01. Enter designated temperature value used for CJC function. This value is a constant and not incremented.

4. SELF-DIAGNOSTICS

The temperature transmitter continually monitors its own performance during normal operation. If an error occurs, it displays and records the error to the logging parameters, and with the integral indicator, an error code corresponding to the error is displayed.

4.1 Error Message

An error message is displayed on the BT200 when there is a problem with functions. The error message can be checked with the parameter number of each item \square 60:SELF CHECK. In addition, the error code is displayed when the transmitter is equipped with the integral indicator. See Table 4.1 below for the error contents corresponding to the error messages, error codes, and their countermeasures.

● Example: Checking by the BT200

```

PARAM
A10:PV
  125.06 degC
A11:mA of RANGE
  16.51 mV
A12:% of RANGE
  50.25 %
DATA  DIAG  PRNT  ESC
        
```

1. Press [F2] (DIAG) to go to the diagnostics panel (A60: SELF CHECK).

```

HOME
A60:SELF CHECK
  ERROR
<ERROR          >
<SENSOR1 FAILURE >
<Sns Backup Start>
<SENSOR2 FAILURE >
FEED  PRNT  ESC
        
```

2. Error messages are shown when the error occurs.

F0401.EPS

● Example: Checking by the integral indicator

Error codes are shown when the errors occur.

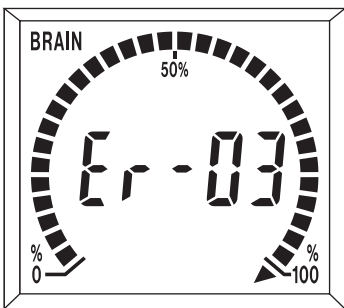

Note : To display the error code, set M55: Err-NO DISP to SHOW.

F0402.EPS

Table 4.1 List of Error Codes

Indicator	BT200 display	Cause	Output operation upon error	Action
N/A	GOOD			
Er-01	Output Too Low	Input value is lower than the PV low range value.	Outputs goes to minimum value. (3.68 mA, -2.0%)	Check the LRV and adjust.
Er-02	Output Too High	Input value is higher than the PV Upper range value.	Outputs goes maximum value. (20.8 mA, 105%)	Check the URV and adjust.
Er-03	Sensor1 Failure	Sensor1 fails or disconnects from the terminal box.	If sensor1 is set as PV, burnout value is output. ^{*1} When sensor backup mode is set in YTA320, sensor2 input is used as PV.	<ul style="list-style-type: none"> • Check sensor for damage. • Check terminal connection. • If in sensor backup mode refer to "Er-09."
Er-04	Sensor2 Failure (YTA320 only)	Sensor2 fails or disconnects from the terminal box.	If sensor1 value is set as PV, and the sensor backup mode is effect, the sensor burnout value is output. ^{*1}	<ul style="list-style-type: none"> • Check sensor for damage. • Check terminal connection. • If sensor backup mode is set, repair wiring or replace damage sensors.
Er-05	S1 Signal Error	Sensor1 input value greatly exceeds sensor measurement range. Sensor type or connection polarity may be incorrect.	Outputs goes to minimum value (3.68 mA) or maximum value (20.8 mA).	<ul style="list-style-type: none"> • Check sensor connections. • Check sensor type selected.
Er-06	S2 Signal Error (only YTA320)	Sensor2 input value greatly exceeds sensor measurement range. Sensor type or connection polarity may be incorrect.	Outputs goes to minimum value (3.68 mA) or maximum value (20.8 mA).	<ul style="list-style-type: none"> • Check sensor connections. • Check sensor type selected.
Er-07	Amb Temp Low	The ambient temperature exceeds the lower ambient temperature limit of the transmitter.	Continues to operate and output.	Use a heat source to raise the temperature of the transmitter.
Er-08	Amb Temp High	The ambient temperature exceeds the upper ambient temperature limit of the transmitter.	Continues to operate and output.	Use a cooling source to lower the temperature of the transmitter.
Er-09	Sns Backup Start (only YTA320)	Sensor backup mode is in effect.	Sensor2 input is used as PV. If sensor2 fails, the transmitter operates with burnout setting.	Repair or replace sensor1 then enable sensor1 normal connection parameters, or repower the transmitter.
Er-10	Illegal PV MAP	There is a problem with the PV mapping setting.	Check output status immediately before error is stored.	Correct the PV mapping.
Er-11	Term Sns Failure	Terminal block sensor has failed.	Continues operate and output.	Contact Service personnel.
Er-12	EEPROM Failure	EEPROM failed.	The output goes to the value set by the hardware error mode jumper. ^{*2}	Contact Service personnel.
Er-13	CPU Failure	Output circuit hardware failure.	The output goes to the value set by the hardware error mode jumper. ^{*2}	Contact Service personnel.
Er-14	AD Conv Failure	Input circuit hardware failure.	The output goes to the value set by the hardware error mode jumper. ^{*2}	Contact Service personnel.
Er-15	Reverse Cal Fail	Confirmation calculation result is bad.	The output goes to the value set by the hardware failure mode jumper. ^{*2}	Contact Service personnel.

*1: See subsection 3.2.9 (a) 'Sensor burn out.'

*2: See subsection 3.2.9 (b) 'Confirming the output direction if Hardware error occurs.'

T0401.EPS

4.2 Warning

1) Warning and contents

The YTA series has a warning display function.

The warning display function displays a warning when there is an incorrect use status such that a setting is out of the specified range. Also, when the instrument is operated in other than standard operation mode, that status is displayed as a warning. Factory default setting is to not display the warning. To display the warning, set parameter H55: WARNING ENBL. Use parameter I59: WARNING to confirm the warning. See Table 4.2 for contents corresponding to warnings and counter-measures.

2) Setting warning display

Classified warnings can be displayed with H55: WARNING ENBL. The warning is classified as follows.

- Setting** : Occurs when an inappropriate parameter setting is used such as out of the specification range of the transmitter.
- Operation** : Occurs when the input value for the parameter setting is out of the setting range.
- Special** : Occurs when the parameter of a function unique to the YTA is set during forced output operation or reverse output operation.

Setting	Operation status	Special	Data to set
×	×	×	00000000
○	×	×	3F1C0000
×	○	×	C0030800
○	○	×	FF1F0800
×	×	○	00E00108
○	×	○	3FFC0108
×	○	○	C0E30908
○	○	○	FFFF0908

○ = display, × = no display

T0403.EPS

● Example: Displaying “Setting” and “Special” warning

```
SET
H50:WARNING ENBL
00000000
3FFC0108
[DEL] [CLR] [ESC]
```

1. Set “3FFC0108” in the Data to set column for F combination in the table above.

2. Press [ENTER] twice.

```
SET
I59:WARNING
GOOD
[ ] [ ] [ ] [ESC]
```

Warning can be checked with I59: WARNING.

```
SET
I59:WARNING
WARNING
< WARNING >
<Out Manual Mode >
<Can Write data >
[ ] [ ] [ ] [ESC]
```

F0403.EPS

Table 4.2 List of warnings

Class	Parameter	Status	Countermeasure
Setting	LRV Too Low	The LRV setting is lower than the temperature range (GS stated value).	Check the LRV setting.
	LRV Too High	The LRV setting is higher than the temperature range (GS stated value).	Check the LRV setting.
	URV Too Low	The URV setting is lower than the temperature range (GS stated value).	Check the LRV setting.
	URV Too High	The URV setting is higher than the temperature range (GS stated value).	Check the URV setting.
	LRV>=URV setting	The LRV and URV settings are reversed.	Set LRV < URV.
	Span Too Small	The setting is lower than the recommended minimum span.	Set URV-LRV to be set to greater than minimum span.
	Illegal SV MAP	There is a problem with input (setting status) specified to SV map.	Correct SV mapping
	Illegal TV MAP	There is a problem with input (setting status) specified to TV map.	Correct TV mapping
	Illegal 4V MAP	There is a problem with input (setting status) specified to 4V map.	Correct 4V mapping
Operation status	Snsr1 Temp Low	Sensor1 input temperature is lower than the temperature range. The measurement range is a YTA series specification but not a range defined by sensor type.	Check process temperature and set new LRV and URV values. Verify correct sensor selection for temperature range.
	Snsr1 Temp High	Sensor1 input temperature is higher than the temperature range. The measurement range is a YTA series specification but not a range defined by sensor type.	Check process temperature and set new LRV and URV values. Verify correct sensor selection for temperature range.
	Snsr2 Temp Low	Sensor2 input temperature is lower than the temperature range. The measurement range is a YTA series specification but not a range defined by sensor type.	Check process temperature and set new LRV and URV values. Verify correct sensor selection for temperature range.
	Snsr2 Temp High	Sensor2 input temperature is higher than the temperature range. The measurement range is a YTA series specification but not a range defined by sensor type.	Check process temperature and set new LRV and URV values. Verify correct sensor selection for temperature range.
	Last SUM Area	The EEPROM checksum field is using the spare 4 (the last area). This means there is no spare area for writing the EEPROM checksum.	There is no problem with current operation. If EEPROM is damaged an EEPROM FAILURE will be indicated.
Special	Out Reverse Mode	Output reverse mode operation is ongoing.	Turning output reverse mode OFF causes normal output .
	Out Manual Mode	Forced output mode is on. In this case, the forced output is active or the output adjustment is performed.	The transmitter is in manual output mode. Return to normal operation if desired.
	Snsr Backup Mode	The sensor backup mode is set.	Turn the sensor backup mode OFF.
	Soft Not Protect	This is the parameter write enable status. Unexpected write cannot be prevented.	Set the protect parameter to YES to enable write protect mode and prevent unexpected changes.

T0402.EPS

4.3 Logging Function

The YTA series has the capability to store useful information for trouble shooting.

4.3.1 Error Log

Up to four error histories are stored in the transmitter memory. The transmitter records an error that continues to occur for more than 6 minutes.

P20:ERR LOG 1

This parameter records the latest errors that occurred.

P21:ERR LOG 2

This parameter records the last errors that have occurred.

P22:ERR LOG 3

This parameter records the 2nd to last error.

P23:ERR LOG 4

This parameter records the 3rd to last error.

P24: ERR LOG CLR Error log clear processing

Clears all error logging data.

4.3.2 Min/Max Log

Minimum and Maximum values of the process variables and terminal temperature are stored in the transmitter memory. The logged data for the process variables except for the terminal temperature is reset at every power off.

To clear the logging data for process variables, select "ENABLE" at P05: ERR LOG CLR.

4.3.3 Operation Time

P30: OPERATE TIME

The transmitter's operation time from the last power up is counted. The information is reset at every power off. The accuracy of time counting is not guaranteed. It is simply a reference.

4.3.4 Power Check

P31: POWER CHECK

By setting this parameter to START after power up, the transmitter can be checked to see if a temporary loss of power has occurred. This parameter is always reset to STOP at power off.

4.3.5 BRAIN communication BCC error occurrence rate

P40: BCC ERROR %

Displays the BCC error occurrence rate of BRAIN communication.

The % value is calculated from the number of BCC errors that occurred in BRAIN communication reception frame and the number of transmissions/receptions.

Turning the power off clears the data.

*1 : This parameter should display the 0 % in normal operation. If it consistently displays other than that, check the cable wiring for the transmitter.

*2 : BBC = BRAIN Communication Check.

5. LIST OF PARAMETERS

NO. ^{*1}	Parameter name	Content	R/W ^{*2}	Remarks	Data initial value			Applicable model			UPLOAD DATA ^{*3}	
					YTA110	YTA310	YTA320	110	310	320	SET	ALL
01	MODEL	Model	R		YTA110	YTA310	YTA320	○	○	○		
02	TAG No.	Tag number	R		Specified upon order			○	○	○		
03	SELF CHECK	Self-diagnostics	R		GOOD			○	○	○		
A	VARIABLE	Variable	R					○	○	○		
A10	PV	Primary variable	R	Unit specified in B11	Operation			○	○	○		
A11	mA of RANGE	Output in mA	R	3.6 to 21.6 mA	Operation			○	○	○		
A12	% of RANGE	Output in %	R	-2 to 110%	Operation			○	○	○		
◆A20	SV	Secondary variable	R	Unit specified in B21	Operation			○	○	○		
◆A30	TV	Tertiary variable	R	Unit specified in B31	Operation			○	○	○		
◆A40	4V	Fourth variable	R	Unit specified in B41	Operation			○	○	○		
A50	TERM	Terminal temperature	R	Unit specified in B51	Operation			○	○	○		
A60	SELF CHECK	Self-diagnostics	R	GOOD, ERROR, Lower Output, Upper Output, Sensor1 Failure, Sensor2 Failure, S1 Signal Error, S2 Signal Error, Lower Amb TEMP, Upper Amb TEMP, Sns Backup Start, Illegal PV MAP, Term Sns Failure, EEPROM Failure, CPU Failure, AD Conv Failure, Reverse Cal Fail	GOOD			○	○	○		
B	SET VAR CON.	Set process variable condition	R					○	○	○		
B05	SET DIFF	Set differential direction	W	Sensor1-Sensor2, Sensor2-Sensor1	Sensor1-Sensor2					○	○	○
B10	PV is	PV mapping	W	Sensor1, Sensor2*, DIFFERENCE*, AVERAGE*, Sensor1-Term, Sensor2-Term*, Terminal Temp (* item can be selected only with YTA320)	Sensor1			○	○	○	○	○
B11	PV UNIT	PV engineering unit	W	degC, kelvin, degF ^{*4} , degR ^{*4}	degC			○	○	○	○	○
B12	PV DAMPING	PV damping time constant	W	0 to 99 seconds	2 seconds			○	○	○	○	○
B13	PV DMP POINT	PV damping holding point	W	0 to 99%	2 %			○	○	○	○	○
B20	SV is	SV mapping	W	Sensor1, Sensor2*, DIFFERENCE*, AVERAGE*, Sensor1-Term, Sensor2-Term*, Terminal Temp Not Used (* item can be selected only with YTA320)	Not Used	Sensor2		○	○	○	○	○
◆B21	SV UNIT	SV engineering unit	W	degC, kelvin, degF ^{*4} , degR ^{*4}	degC			○	○	○	○	○
◆B22	SV DAMPING	SV damping time constant	W	0 to 99 seconds	2 seconds			○	○	○	○	○
B30	TV is	TV mapping	W	Same as B20	Not Used			○	○	○	○	○
◆B31	TV UNIT	TV engineering unit	W	degC, kelvin, degF ^{*4} , degR ^{*4}	degC			○	○	○	○	○
◆B32	TV DAMPING	TV damping time constant	W	0 to 99 seconds	2 seconds			○	○	○	○	○
B40	4V is	4V mapping	W	Same as B20	Not Used			○	○	○	○	○
◆B41	4V UNIT	4V engineering unit	W	degC, kelvin, degF ^{*4} , degR ^{*4}	degC			○	○	○	○	○
◆B42	4V DAMPING	4V damping time constant	W	0 to 99 seconds	2 seconds			○	○	○	○	○
B51	TERM UNIT	Terminal temperature unit	W	degC, kelvin, degF ^{*4} , degR ^{*4}	degC			○	○	○	○	○
B60	SELF CHECK	Self-diagnostics	R	Same as A60	GOOD			○	○	○		
C	SET TAG	Set Tag number	R					○	○	○		
C10	TAG NO.	Tag number	W	16 alphanumeric characters	Specified upon order			○	○	○		○ ^{*5}
C60	SELF CHECK	Self-diagnostics	R	Same as A60	GOOD			○	○	○		
D	SET SENSOR1	Set Sensor1	R					○	○	○		
D10	SENSOR1 TYPE	Sensor1 sensor type	W	TYPE B, E, J, K, L, N, R, S, T, U, W3, W5, Pt100, Pt200, Pt500, JPt100, Ni120, Cu, ohm, mV, Non Connection	Pt100			○	○	○	○	○
◆D20	SENSOR1 WIRE	Sensor1 wire connection	W	2 WIRE, 3 WIRE, 4 WIRE	3 WIRE			○	○	○	○	○
◆D40	SENSOR1	Sensor1 input value	R	Unit specified in D20	Operation			○	○	○		
◆D41	SENSOR1 UNIT	Sensor1 engineering unit	W	degC, kelvin, degF ^{*4} , degR ^{*4}	degC			○	○	○	○	○
●D50	SNSR1 MATCH	Sensor1 RTD sensor matching	W	DISABLE, ENABLE	DISABLE			○	○	○		
●D51	SNSR1 R0	Sensor1-specific constant (R0)	W		+100			○	○			
●D52	SNSR1 A	IEC co-efficient α	W		+3.9083 E-3			○	○			
●D53	SNSR1 B	IEC co-efficient δ	W		-5.7749 E-7			○	○			
●D54	SNSR1 C	IEC co-efficient β	W		-4.183 E-12			○	○			
●D55	SNSR1 ALPHA	Callendar-Van-Dusen co-efficient A	W		+3.8505 E-3			○	○			
●D56	SNSR1 DELTA	Callendar-Van-Dusen co-efficient B	W		+1.4998 E0			○	○			
●D57	SNSR1 BETA	Callendar-Van-Dusen co-efficient C	W		+1.0862 E-1			○	○			
D60	SELF CHECK	Self-diagnostics	R	Same as A60	GOOD			○	○	○		

*1: ◆ indicates parameters which may be displayed depending on the setting for other parameters. ● indicates parameters available on the model with optional code /CM1.

*2: RW: R = Read only, W = Read & Write

*3: Indicates the parameter selected by H30: UPLOAD SELECT.

SET = SET PRAM ONLY parameters

ALL = ALL PRAM parameters

*4: degF and degR can be selected only when optional code /D2 is specified.

*5: This parameter will not be printed at PRINTOUT upon UPLOAD/DOWNLOAD, although the parameter itself is UPLOADED/DOWNLOADED.

5. LIST OF PARAMETERS

NO. ^{*1}	Parameter name	Content	R/W ^{*2}	Remarks	Data initial value			Applicable model			UPLOAD DATA ^{*3}		
					YTA110	YTA310	YTA320	110	310	320	SET	ALL	
E	SET SENSOR2	Set Sensor2	R										
E10	SENSOR2 TYPE	Sensor2 sensor type	W	TYPE B, E, J, K, L, N, R, S, T, U, W3, W5, Pt100, Pt200, Pt500, JPt100, Ni120, Cu, ohm, mV, Non Connection	—		Pt100				○	○	○
◆E20	SENSOR2 WIRE	Sensor2 wire connection	W	2 WIRE, 3 WIRE	—		3 WIRE				○	○	○
◆E40	SENSOR2 TEMP	Sensor2 input value	R	Unit specified in E20			Operation				○		
◆E41	SENSOR2 UNIT	Sensor2 engineering unit	W	degC, kelvin, degF ^{*4} , degR ^{*4}			degC				○	○	○
●E50	SNSR2 MATCH	Sensor1 RTD sensor matching	W	DISABLE, ENABLE			DISABLE				○		
●E51	SNSR2 R0	Sensor1-specific constant (R0)	W				+100				○		
●E52	SNSR2 A	IEC co-efficient α	W				+3.9083 E-3				○		
●E53	SNSR2 B	IEC co-efficient δ	W				-5.7749 E-7				○		
●E54	SNSR2 C	IEC co-efficient β	W				-4.183 E-12				○		
●E55	SNSR2 ALPHA	Callendar-Van-Dusen co-efficient A	W				+3.8505 E-3				○		
●E56	SNSR2 DELTA	Callendar-Van-Dusen co-efficient B	W				+1.4998 E0				○		
●E57	SNSR2 BETA	Callendar-Van-Dusen co-efficient C	W				+1.0862 E-1				○		
E60	SELF CHECK	Self-diagnostics	R	Same as A60			GOOD				○		
F	SET OUTPUT	Set output	R								○	○	○
F10	LRV	Lower range value	W	-5000 to +5000°C			+0(degC)				○	○	○
F20	URV	Upper range value	W	-5000 to +5000°C			+100(degC)				○	○	○
F30	AUTO LRV	Automatic setting of lower range value	W	DISABLE, ENABLE(-5000 to +5000°C)			DISABLE				○	○	○
F35	AUTO URV	Automatic setting of upper range value	W	DISABLE, ENABLE(-5000 to +5000°C)			DISABLE				○	○	○
F40	BURN OUT	Sensor error burn-out output	W	LOW, HIGH, USER mA, USER %, OFF			High				○	○	○
◆F41	BURN OUT VAL	Sensor error burn-out value	W	3.6 to 21.6mA (-2.5 to 110%)			110(%)				○	○	○
F50	TX FAILURE	Hardware error burn-out	R	LOW, HIGH			High				○	○	○
F60	SELF CHECK	Self-diagnostics	R	Same as A60			GOOD				○	○	○
G	FORCED OUT	Forced output	R								○	○	○
G10	OUTPUT MODE	Output mode	W	AUTOMATIC MODE, MANUAL MODE mA, MANUAL MODE %			AUTOMATIC MODE				○	○	○
◆G20	OUTPUT VALUE	Forced output value	W	3.6 to 21.6mA (-2.5 to 110%)			Operation				○	○	○
G60	SELF CHECK	Self-diagnostics	R	Same as A60			GOOD				○	○	○
H	SET MODE	Set Modes	R								○	○	○
H01	CJC SELECT	CJC Selection	W	Internal CJC, Constant CJC			Internal CJC				○	○	○
◆H02	CNST CJC TMP	Constant for CJC function	W	-5000 to +5000°C			0				○	○	○
H10	REVERSE OUT	Reverse output	W	DISABLE, ENABLE			DISABLE				○	○	○
H20	SNSR BACKUP	Sensor backup	W	DISABLE, ENABLE			DISABLE				○		
◆H21	RETURN SNS1	Return Sensor1	W	ENABLE, DISABLE			DISABLE				○		
H30	UPLOAD SELCT	Upload parameter select	W	SET PRAM ONLY, ALL PRAM			SET PRAM ONLY				○	○	○
H40	WRITE PROTCT	Write protect	W	YES, NO			NO				○	○	○
H50	WARNING ENBL	Warning function	W	00000000, 3F1C0000, C0030800, FF1F0800, 00E00108, 3FFC0108, C0E30908, FFFF0908			00000000				○	○	○
H60	SELF CHECK	Self-diagnostics	R	Same as A60			GOOD				○	○	○
I	INFORMATION	Information	R										
I10	PV LRL	PV lower range limit	R				-200(degC)				○	○	○
I11	PV URL	PV upper range limit	R				+850(degC)				○	○	○
I12	PV MIN SPAN	PV minimum span	R				+25(degC)				○	○	○
◆I20	SNSR1 LSL	Sensor1 lower sensor limit	R				-200(degC)				○	○	○
◆I21	SNSR1 USL	Sensor1 upper sensor limit	R				+850(degC)				○	○	○
◆I30	SNSR2 LSL	Sensor2 lower sensor limit	R				—	-200(degC)			○		
◆I31	SNSR2 USL	Sensor2 upper sensor limit	R				—	+850(degC)			○		
I40	TERM LSL	Terminal lower sensor limit	R				-40(degC)				○	○	○
I41	TERM USL	Terminal upper sensor limit	R				+85(degC)				○	○	○
I59	WARNING	Warning	R	GOOD/Warning, LRV Low Limited, LRV Upp Limited, URV Low Limited, URV Upp Limited, LRV>=URV set, SPAN Below, Sns1 TEMP Little, Sns1 TEMP Large, Sns2 TEMP Little, Sns2 TEMP Large, Illegal SV MAP, Illegal TV MAP, Illegal 4V MAP, Out Reverse Mode, Out Manual Mode			GOOD				○	○	○
I60	SELF CHECK	Self-diagnostics	R	Same as A60			GOOD				○	○	○

*1: ◆ indicates parameters which may be displayed depending on the setting for other parameters. ● indicates parameters available on the model with optional code /CM1.

*2: RW: R = Read only, W = Read & Write

*3: Indicates the parameter selected by H30: UPLOAD SELCT.

SET = SET PRAM ONLY parameters

ALL = ALL PRAM parameters

*4: degF and degR can be selected only when optional code /D2 is specified.

5. LIST OF PARAMETERS

NO. ^{*1}	Parameter name	Content	R/W ^{*2}	Remarks	Data initial value			Applicable model			UPLOAD DATA ^{*3}	
					YTA110	YTA310	YTA320	110	310	320	SET	ALL
J	CAL SENSOR1	Sensor1 sensor trim	R					○	○	○		
◆J05	SNSR1 CLR	Sensor1 trim value clear	W	USER CAL ACT, USER CAL IGNORE, USER CAL CLEAR	USER CAL ACT			○	○	○		
J07	IN TRIM MODE	Input Sensor Trimming Mode	W	V.R/ZERO&GAIN, V.R/ZERO, TEMP/ZERO&GAIN, TEMP/ZERO	V.R/ZERO&GAIN			○	○	○		
◆J10	SNSR1 ZERO	Sensor1 zero point adjustment	W		0			○	○	○		
◆J20	SNSR1 GAIN	Sensor1 gain point adjustment	W		0			○	○	○		
◆J30	SNSR1 SERIAL	Sensor1 serial number	W	000000 to 999999	0			○	○	○	○	
J60	SELF CHECK	Self-diagnostics	R	Same as A60	GOOD			○	○	○		
K	CAL SENSOR2	Sensor2 sensor trim	R									
◆K05	SNSR2 CLR	Sensor2 trim value clear	W	USER CAL ACT, USER CAL IGNORE, USER CAL CLEAR	USER CAL ACT						○	
◆K10	SNSR2 ZERO	Sensor2 zero point adjustment	W		0					○		
◆K20	SNSR2 GAIN	Sensor2 gain point adjustment	W		0					○		
◆K30	SNSR2 SERIAL	Sensor2 serial number	W	000000 to 999999	0						○	
K60	SELF CHECK	Self-diagnostics	R	Same as A60	GOOD						○	
L	CAL OUTPUT	Analog output trim	R					○	○	○		
L05	OUT CLR	Output trim value clear	W	USER CAL ACT, USER CAL IGNORE, USER CAL CLEAR	USER CAL ACT			○	○	○		
L10	OUTPUT MODE	Output mode	W	AUTOMATIC MODE, MANUAL MODE 4mA, MANUAL MODE 20mA	AUTOMATIC MODE			○	○	○		
◆L20	OUT ZERO	Output zero point adjustment	W	0.6V to 1.4V	0			○	○	○		
◆L30	OUT GAIN	Output gain point adjustment	W	4.6V to 5.4V	0			○	○	○		
L60	SELF CHECK	Self-diagnostics	R	Same as A60	GOOD			○	○	○		
◆M	SET METER	Set Meter	R					○	○	○		
◆M10	PROCESS DISP	Process variable display	W	PV, SV, TV, 4V, PV-SV, PV-SV-TV, PV-SV-TV-4V, INHIBIT	PV			○	○	○	○	○
◆M20	%/mA DISP	Output in % / mA display	W	mA, %, mA-%, INHIBIT	mA			○	○	○	○	○
◆M30	MATRIX DISP	Dot matrix display	W	PROCESS, TYPE, WIRE, PROCESS-TYPE, TYPE-WIRE, INHIBIT	PROCESS			○	○	○	○	○
◆M40	BAR GRAPH	Output bar graph display	W	SHOW, INHIBIT	SHOW			○	○	○	○	○
◆M50	DISP UPDATE	Display update speed	W	FAST, NORMAL, SLOW	NORMAL			○	○	○	○	○
◆M55	Err-NO DISP	Error number display	W	SHOW, INHIBIT	SHOW			○	○	○	○	○
◆M60	SELF CHECK	Self-diagnostics	R	Same as A60	GOOD			○	○	○		
O	MEMO	Memo	R					○	○	○		
O10	MEMO1	Memo 1	W	16 alphanumeric characters	(Blank)			○	○	○		○ ₅
O20	MEMO2	Memo 2	W	16 alphanumeric characters	(Blank)			○	○	○		○ ₅
O30	DESCRIPTOR	Description	W	16 alphanumeric characters	(Blank)			○	○	○		○ ₅
O40	DATE	Date	W	6 alphanumeric characters	(Blank)			○	○	○		○
O60	SELF CHECK	Self-diagnostics	R	Same as A60	GOOD			○	○	○		
P	RECORDS	Records	R									
P05	LOG CLEAR	Log clear	R	DISABLE, ENABLE	DISABLE			○	○	○		
P10	PV MIN LOG	PV minimum log	R		Operation			○	○	○		
P11	PV MAX LOG	PV maximum log	R		Operation			○	○	○		
◆P12	SV MIN LOG	SV minimum log	R		Operation			○	○	○		
◆P13	SV MAX LOG	SV maximum log	R		Operation			○	○	○		
◆P14	TV MIN LOG	TV minimum log	R		Operation			○	○	○		
◆P15	TV MAX LOG	TV maximum log	R		Operation			○	○	○		
◆P16	4V MIN LOG	4V minimum log	R		Operation			○	○	○		
P17	4V MAX LOG	4V maximum log	R		Operation			○	○	○		
P18	TERM MIN LOG	Terminal minimum log	R		15°C			○	○	○		
P19	TERM MAX LOG	Terminal maximum log	R		35°C			○	○	○		
P20	ERR LOG1	Error log 1	R	Error message display	GOOD			○	○	○		
P21	ERR LOG2	Error log 2	R	Error message display	GOOD			○	○	○		
P22	ERR LOG3	Error log 3	R	Error message display	GOOD			○	○	○		
P23	ERR LOG4	Error log 4	R	Error message display	GOOD			○	○	○		
P24	ERR LOG CLR	Error log clear	W	DISABLE, ENABLE	DISABLE			○	○	○		
P30	OPERATE TIME	Transmitter operation time (after instantaneous interrupt detection operation starts)	R		Operation			○	○	○		
P31	POWER CHECK	Instantaneous interrupt detection history & detection start	W	STOP, START	STOP			○	○	○		
P40	BCC ERROR %	BRAIN communication BCC error generation rate	R		0 %			○	○	○		
P60	SELF CHECK	Self-diagnosis	R	Same as A60	GOOD			○	○	○		

*1: ◆ indicates parameters which may be displayed depending on the setting for other parameters.

*2: RW: R = Read only, W = Read & Write

*3: Indicates the parameter selected by H30: UPLOAD SELCT.

SET = SET PRAM ONLY parameters

ALL = ALL PRAM parameters

*4: degF and degR can be selected only when optional code /D2 is specified.

*5: This parameter will not be printed at PRINTOUT upon UPLOAD/DOWNLOAD, although the parameter itself is UPLOADED/DOWNLOADED.

APPENDIX A. OPERATION OF BRAIN TERMINAL BT200

A.1 Operation Key Arrangement

Figure 5.3 shows the key pad layout of the BT200.

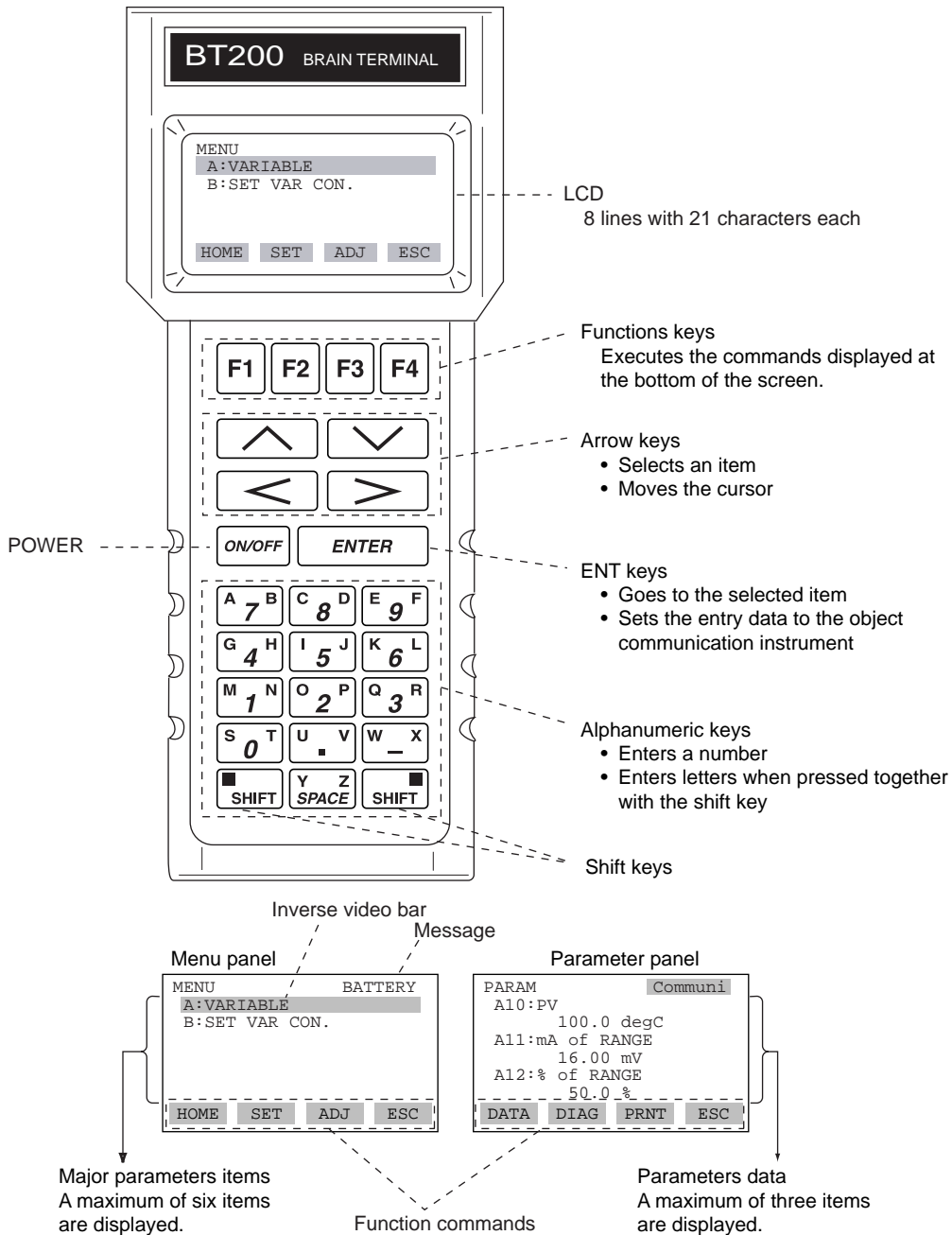

FOA01.EPS

Figure A.1 Key arrangement and screen display of BT200

A.2 Function of Operation Keys

A.2.1 Entry of Alphanumeric Characters

Numbers, codes, and letters can be entered in combinations of the alphanumeric keys and the SHIFT key.

- **Entry of numbers, codes, and a space (0 to 9, ., -, ␣)**

Enter these items by using the alphanumeric key.

Example of Entry	Key Operation
-4.3	W X → G 4 H → U . Y → Q 3 R
1 ␣ -0.3	M 1 N → Y Z SPACE → W X → S 0 T → U . V → Q 3 R

FOA02.EPS

- **Entry of letters**

The letter on the same side of the key as the shift key that is pressed can be entered. Press the SHIFT keys first and then press an alphanumeric key. Press the SHIFT key each time when entering a letter.

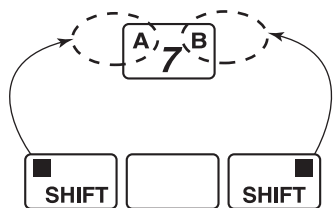

(The letter on the left side of the alphanumeric key is entered.)

(The letter on the right side of the alphanumeric key is entered.)

FOA03.EPS

Example of Entry	Key Operation
WIC	SHIFT → W X → SHIFT → I 5 J → SHIFT → C 8 D
J.B	SHIFT → I 5 J → U . V → SHIFT → A 7 B

FOA04.EPS

- **Selection of uppercase/lowercase of letters**

Uppercase and lowercase letters can be selected alternately by pressing the function key [F2] (CAPS).

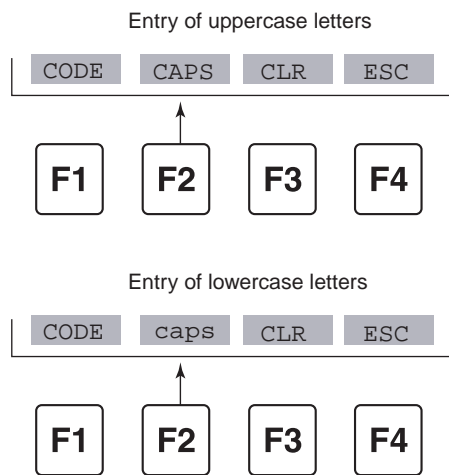

FOA05.EPS

- **Entry of codes**

Codes can be entered by pressing the function key [F1] (CODE). Every time [F1] CODE is pressed, the codes are displayed at the cursor position in the order shown below.

/ . - , + *) (' & % \$ # " !

To enter characters after the codes above, move the cursor using the [>] key before entry.

Example of Entry	Key Operation
l/m	F2 → SHIFT → K 6 L → F1 → > → SHIFT → M 1 N (Lower- (l) (/) (m) case letter)

FOA06.EPS

A.2.2 Function Keys

The functions of the function keys vary with the commands being displayed on the display screen.

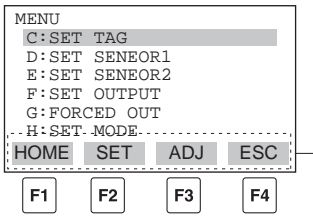

Command	Description
ADJ	Calls up the zero-adjustment menu.
CAPS/caps	Changes the uppercase/lowercase mode.
CLR	Clears entered data/deletes all data.
COPY	Prints parameters on the screen.
DATA	Updates parameter data.
DEL	Deletes one character.
DIAG	Calls up the self-check screen.
ESC	Returns to the preceding screen.
FEED	Paper feed.
GO	Starts print out.
HOME	Calls up the home menu (A: DISPLAY).
LIST	Prints all parameters of the menus.
NO	Setting stop/re-setting. Returns to the previous screen.
OK	Goes to the next screen.
PARM	Parameter number setting mode.
PON/POFF	Printer output of data whose setting was changed Mode on/off.
PRNT	Changes to the prints mode.
SET	Calls up the setting menu. (B: SETTING)
SLOT	Returns to the slot selection screen.
STOP	Stops printing.
UTIL	Transfers to the utility screen.

F0A07.EPS

A.3 Calling of Menu Address

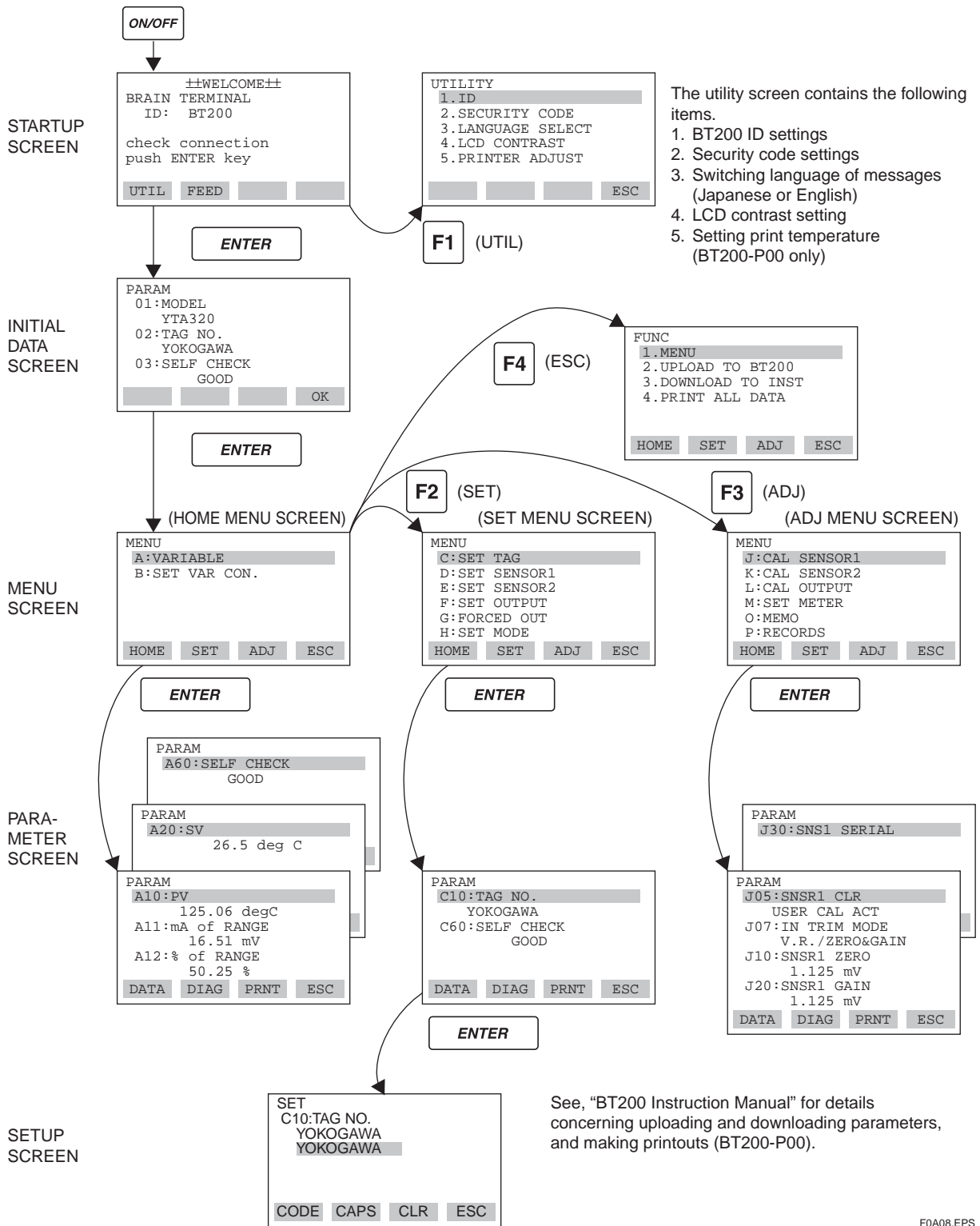

Calling up menu address using the operating keys

FOA08.EPS

A.3.1 Data Display with BT200

The following procedure is used to display data on the BT200 screen.

Display	Description
	Press the ON/OFF key to turn on the BT200. "Please wait..." is displayed for several seconds and [Start display] is displayed.
[STARTUP SCREEN] 	Connect YTA and BT200 using a communication cable and press the ENTER key.
[INITIAL DATA SCREEN] 	Displays the model name, the tag number, and diagnostics information. Press the F4 (OK) key after confirmation. (The text specified upon order is set for TAG.)
[HOME MENU SCREEN] 	While the highlight bar is at A: VARIABLE, press the ENTER key to enter the parameter display.
[PARAMETER SCREEN] 	<ul style="list-style-type: none"> A maximum 3 items of data is displayed on one screen. Communication is executed at 5-second intervals. (Data is updated in a 5-second cycle.) Use for page forward and item selection.
[PARAMETER SCREEN] 	<p>Execution of function keys</p> <p>F1 : Updates the current data. Pressing this key forces communication with the connected equipment and the data of the equipment is read and displayed.</p> <p>F2 : Displays the self-diagnosis screen.</p> <p>F3 : Displays the parameter print screen.</p> <p>F4 : Returns to the previous screen (the menu screen)</p>

FOA09.EPS

A.3.2 Data Setting with BT200

The following procedure is used to change YTA data settings.

● Example: Changing C10 TAG to "FIC-1a."

Display	Description
	Press the ON/OFF key to turn on the BT200. "Please wait..." is displayed for several seconds and [Start display] is displayed.
[STARTUP SCREEN] 	Connect YTA and BT200 using a communication cable and press the ENTER key.
[INITIAL DATA SCREEN] 	Displays the model name, the tag number, and diagnostics information. Press the F4 (OK) key after confirmation. (The text specified upon order is set for TAG.)
[HOME MENU SCREEN] 	Press the F2 (SET) key to display SET menu panel.
[SET MENU SCREEN] 	Select C: SETTING and press the ENTER key.
[PARAMETER SCREEN] 	Select C10: TAG NO. and press the ENTER key.

FOA10.EPS

[SETUP SCREEN]

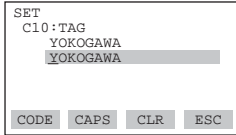

Set the new TAG NO. (FIC-1A)

SHIFT	E 9 F	FOKOGAWA
SHIFT	I 5 J	FIKOGAWA
SHIFT	C 8 D	FICOGAWA
W X		FIC-GAWA
M 1 N		FIC-1AWA
F2 (caps)	SHIFT A 7 B	FIC-1aWA
Y Z SPACE	Y Z SPACE	FIC-1a

(When you have made an entry mistake, return the cursor using the key, then reenter.)

[SETUP SCREEN]

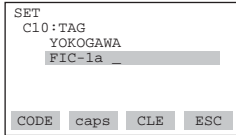

Set TAG NO. and press the key.

[CONFIRMATION SCREEN]

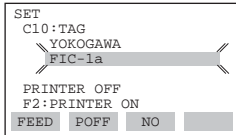

This is the panel for confirming set data. The set data items flash. When all items have been confirmed, press the again. (To go back to the setting panel, press the (NO) key.)

[SETTING COMPLETED SCREEN]

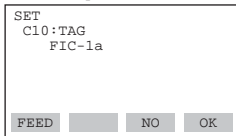

(OK) The YTA TAG NO. was overwritten. Press the (OK) key to return to the parameter panel. Press the (NO) key to return to the setting parameter.

[PARAMETER SCREEN]

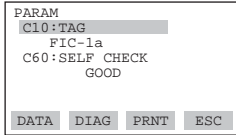

F0A11.EPS

APPENDIX B. THE SENSOR MATCHING FUNCTION

B.1 Specifications

Function: The sensor-specific constants can be programmed into the transmitter.

Applicable model: YTA310 /CM1, YTA320 /CM1

RTD sensor: Pt100, Pt200, Pt500

Significant temperature measurement accuracy improvement can be attained using a temperature sensor that is matched to a temperature transmitter. This matching process entails teaching the temperature transmitter the relationship between resistance and temperature for a specific RTD sensor. This relationship, approximated by the Callendar-Van Dusen equation, is described as:

$$R_t = R_0 \{ 1 + \alpha (1 + 0.01\delta) t - \alpha\delta / 10^4 t^2 - \alpha\beta / 10^8 (t - 100) t^3 \}$$

where: R_t = Resistance (ohms) at Temperature t (°C)

R_0 = Sensor - Specific Constant
(Resistance at $t = 0$ °C)

α = Sensor - Specific Constant

δ = Sensor - Specific Constant

β = Sensor - Specific Constant (0 at $t > 0$ °C)

The exact values for R_0 , α , δ , and β are specific to each RTD sensor, and are obtained by testing each individual sensor at various temperatures. These constants are known as Callendar-Van Dusen constants.

Generally the constants R_0 , A , B , and C are also being used as the characteristic coefficients of the sensor instead of R_0 , α , δ , and β . These are derived from the IEC Standard Curve and the relationship is described as:

$$R_t = R_0 [1 + At + Bt^2 + C (t - 100) t^3]$$

where: R_t = Resistance (ohms) at Temperature t (°C)

R_0 = Sensor - Specific Constant
(Resistance at $t = 0$ °C)

A = Sensor - Specific Constant

B = Sensor - Specific Constant

C = Sensor - Specific Constant (0 at $t > 0$ °C)

These two equations are equivalent. A model YTA can cope with either case above-mentioned.



IMPORTANT

There is the following limitations for R_0 , α , δ , β , A , B , and C with the YTA.

- It is necessary to enter the value, which is normalized by the exponential part specified for each parameter. See Table B.1.
- It is necessary to enter the value, which is rounded off to three or two decimal places specified for each parameter. See Table B.1.
- When a three decimal place data is entered, it may be automatically changed to the four decimal place data that is equivalent to the input data.

Example: +3.809 E-3 → +3.8089 E-3

Table B.1

Item	Number of decimal places	exponential part	Input Example	Factory Initial
R0	2	non	+ 100.05	+100
A	3	E-3 (10 ⁻³)	+ 3.908 E-3	+3.9083 E-3
B	3	E-7 (10 ⁻⁷)	- 5.802 E-7	-5.7749 E-7
C	3	E-12 (10 ⁻¹²)	- 0 E-12	-4.183 E-12
α	3	E-3 (10 ⁻³)	+ 3.850 E-3	+3.8505 E-3
δ	3	E0 (10 ⁰)	+ 1.507 E0	+1.4998 E0
β	3	E-1 (10 ⁻¹)	+ 0 E-1	+1.0862 E-1

T0B01.EPS

B.2 Operations (The Sensor Matching Function)



IMPORTANT

This function is effective only in three kinds of sensors, Pt100, Pt200, and Pt500.

Input relations between the sensor type and the value of R0 properly. When Pt100 is specified as an input type, the value close to 100 must be set to R0. When Pt500 is specified as input type, the value close to 500 must be set to R0.

When the sensor type was changed, the Sensor Matching Parameters must be set up again or the Sensor Matching function must be set to "DISABLE".

Example: To set Pt200, 3wire sensor as "Sensor 1" input.
And to input R0, α , δ , and β values, as sensor-specific constants.

FOB01.EPS

1. Set the sensor type:
 - 1-1. Select D10: SENSOR1 TYPE and press [ENTER].
 - 1-2. Select "Pt200 (IEC751)" and press [ENTER] twice.
 - 1-3. Press [OK].
2. Set the number of wires:
 - 2-1. To set the number of wire connections, select D20: SENSOR1 WIRE and press [ENTER].
 - 2-2. Select "3WIRE" and press [ENTER] twice.
 - 2-3. Press [OK].
3. Set the sensor-specific constants:
 - 3-1. Select D51: SNSR1 R0 and press [ENTER].
 - 3-2. Input R0 values and press [ENTER] twice.
 - 3-3. Press [OK].
 - 3-4. Select D55: SNSR1 ALPHA and press [ENTER].
 - 3-5. Input alpha values and press [ENTER] twice.
 - 3-6. Press [OK].
 - 3-7. Select D56: SNSR1 DELTA and press [ENTER].
 - 3-8. Input delta values and press [ENTER] twice.
 - 3-9. Press [OK].
 - 3-10. Select D57: SNSR1 BETA and press [ENTER].
4. Enable the Sensor Matching function:
 - 4-1. Select D50: SNSR1 MATCH and press [ENTER].
 - 4-2. Select "ENABLE" and press [ENTER] twice.
 - 4-3. Press [OK].

When "DISABLE" is selected in the step 4-2, temperature is calculated by using the default value of R0, α , δ , and β .

If using the A, B, and C parameters, replace D55, D56 and D57 with D52, D53 and D54 in step 3-4 through 3-10.

If using two sensors with a Model YTA320, replace Dnn with Enn (nn is same number) and repeat the procedures for the second sensor.

APPENDIX C. SAFETY INSTRUMENTED SYSTEMS INSTALLATION



WARNING

The contents of this appendix are cited from exida.com safety manual on the YTA series pressure transmitters specifically observed for the safety transmitter purpose. When using the YTA for Safety Instrumented Systems (SIS) application, the instructions and procedures in this section must be strictly followed in order to preserve the transmitter for that safety level.

C.1 Scope and Purpose

This section provides an overview of the user responsibilities for installation and operation of the YTA in order to maintain the designed safety level for Safety Instrumented Systems (SIS) applications. Items that will be addressed are proof testing, repair and replacement of the transmitter, reliability data, lifetime, environmental and application limits, and parameter settings.

C.2 Using the YTA for an SIS Application

C.2.1 Safety Accuracy

The YTA has a specified safety accuracy of 2%. This means that the internal component failures are listed in the device failure rate if they will cause an error of 2% or greater.

C.2.2 Diagnostic Response Time

The YTA will report an internal failure within 8 seconds of the fault occurrence.

C.2.3 Setup

During installation the transmitter must be setup with engineering units parameters. This is typically done with a handheld terminal. These parameters must be verified during the installation to insure that the correct parameters are in the transmitter. Engineering range parameters can be verified by reading these parameters from the optional local display or by checking actual calibration of the transmitter.

The calibration of the transmitter must be performed after parameters are set.

C.2.4 Required Parameter Settings

The following parameters need to be set in order to maintain the designed safety integrity.

Table C.2.4 Required Parameter Settings

Item	Description
Burnout direction switch	To specify if the output should go 21.6 mA or higher or 3.6 mA or lower upon detection of an internal failure.
Write protection switch	The write function should be disabled.

TA0101.EPS

C.2.5 Proof Testing

The objective of proof testing is to detect failures within the transmitter that are not detected by the diagnostics of the transmitter. Of main concern are undetected failures that prevent the safety instrumented function from performing its intended function. See table C.2.5 for proof testing method.

The frequency of the proof tests (or the proof test interval) is to be determined in the reliability calculations for the safety instrumented functions for which the YTA is applied. The actual proof tests must be performed more frequently or as frequently as specified in the calculation in order to maintain required safety integrity of the safety instrumented function.

The following tests need to be specifically executed when a proof test is performed. The results of the proof test need to be documented and this documentation should be part of a plant safety management system. Failures that are detected should be reported to Yokogawa.

The personnel performing the proof test of the transmitter should be trained in SIS operations including bypass procedures, YTA temperature transmitter maintenance, and company management of change procedures.

Table C.2.5 Proof Testing

Testing method	Tools required	Expected outcome	Remarks
<p>Analog Output Loop Test:</p> <ol style="list-style-type: none"> 1. Bypass the safety PLC or take other appropriate action to avoid a false trip. 2. Send a HART or BRAIN command to the transmitter to go to the high alarm current output and verify that the analog current reaches that value. 3. Send a HART or BRAIN command to the transmitter to go to the low alarm current output and verify that the analog current reaches that value. 4. Use the HART or BRAIN communicator to view detailed device status to ensure no alarms or warnings are present in the transmitter. 5. Perform reasonability check on the sensor value(s) versus an independent estimate (i.e. from direct monitoring of BPCS value) to show current reading is good. 6. Restore the loop to full operation. 7. Remove the bypass from the safety PLC or otherwise restore normal operation. 	<ul style="list-style-type: none"> • Handheld terminal 	<p>Proof Test Coverage =61%</p>	<p>The output needs to be monitored to assure that the transmitter communicates the correct signal.</p>
<p>Analog Output Loop Test and Temperature Spot Check:</p> <ol style="list-style-type: none"> 1. Bypass the safety PLC or take other appropriate action to avoid a false trip. 2. Perform Analog Output Loop Test. 3. Verify the measurement for two temperature points. 4. Perform reasonability check of the housing temperature. 5. Restore the loop to full operation. 6. Remove the bypass from the safety PLC or otherwise restore normal operation. 	<ul style="list-style-type: none"> • Handheld terminal 	<p>Proof Test Coverage =96%</p>	<p>The output needs to be monitored to assure that the transmitter communicates the correct signal.</p>

TA0102.EPS

C.2.6 Repair and Replacement

If repair is to be performed with the process online, the YTA will need to be bypassed during the repair. The user should setup appropriate bypass procedures.

In the unlikely event that the YTA has a failure, the failures that are detected should be reported to Yokogawa.

When replacing the YTA, the procedure in the installation manual should be followed.

The personnel performing the repair or replacement of the YTA should have a sufficient skill level.

C.2.7 Startup Time

The YTA generates a valid signal within 5 seconds of power-on startup.

C.2.8 Firmware Update

In case firmware updates are required, they will be performed at factory. The replacement responsibilities are then in place. The user will not be required to perform any firmware updates.

C.2.9 Reliability Data

A detailed Failure Mode, Effects, and Diagnostics Analysis (FMEDA) report is available from Yokogawa with all failure rates and failure modes.

The YTA is certified up to SIL2 for use in a simplex (1oo1) configuration, depending on the PFDavg respectively PFH calculation of the entire Safety Instrumented Function.

The development process of the YTA is certified up to SIL3, allowing redundant use of the transmitter up to this Safety Integrity Level, depending the PFDavg respectively PFH calculation of the entire Safety Instrumented Function.

When using the transmitter in a redundant configuration, the use of a common cause factor (β -factor) of 5% is suggested. If the owner-operator of the plant would institute common cause failure training and more detailed maintenance procedures for avoiding common cause failure, a beta factor of 2% would be applicable.

C.2.10 Lifetime Limits

The expected lifetime of the YTA is 50 years. The reliability data listed in the FMEDA report is only valid for this period. The failure rates of the YTA may increase sometime after this period. Reliability calculations based on the data listed in the FMEDA report for YTA lifetimes beyond 50 years may yield results that are too optimistic, i.e. the calculated Safety Integrity Level will not be achieved.

C.2.11 Environmental Limits

The environmental limits of the YTA are specified in the user’s manual IM 01C50B01-01E.

C.2.12 Application Limits

The application limits of the YTA are specified in the user’s manual IM 01C50B01-01E. If the transmitter is used outside of the application limits, the reliability data listed in C.2.9 becomes invalid.

C.3 Terms and Definitions

FMEDA Failure Mode Effect and Diagnostic Analysis

SIF Safety Instrumented Function

SIL Safety Integrity Level

SIS	Safety Instrumented System – Implementation of one or more Safety Instrumented Functions. A SIS is composed of any combination of sensor(s), logic solver(s), and final element(s).
SLC	Safety Lifecycle
Safety	Freedom from unacceptable risk of harm
Functional Safety	The ability of a system to carry out the actions necessary to achieve or to maintain a defined safe state for the equipment / machinery / plant / apparatus under control of the system
Basic Safety	The equipment must be designed and manufactured such that it protects against risk of damage to persons by electrical shock and other hazards and against resulting fire and explosion. The protection must be effective under all conditions of the nominal operation and under single fault condition
Verification	The demonstration for each phase of the life-cycle that the (output) deliverables of the phase meet the objectives and requirements specified by the inputs to the phase. The verification is usually executed by analysis and / or testing
Validation	The demonstration that the safety-related system(s) or the combination of safety-related system(s) and external risk reduction facilities meet, in all respects, the Safety Requirements Specification. The validation is usually executed by testing.
Safety Assessment	The investigation to arrive at a judgment - based on evidence - of the safety achieved by safety-related systems
Further definitions of terms used for safety techniques and measures and the description of safety related systems are given in IEC 61508-4.	

Revision Record

- Manual No. : IM 01C50T03-01E
- Title : YTA series Temperature Transmitter (BRAIN Protocol)

Edition	Date	Page	Revised item
1st	Sep. 1998	—	New Publication
2nd	Jan. 1999	—	Error correction
3rd	June 1999	Contents B-1 to B-3	Add Appendix B The Sensor Matching Function Add Appendix B The Sensor Matching Function
4th	July 2000	Cover Contents 3-3 3-16 4-3 5-2, 5-3	Add style No. Add 3.2.16 Add parameters H01 & H02 Add "3.2.16 CJC Selection" Change Table data (T0403E) Change of parameter table
5th	Sep. 2006	Cover Contents 1-1 to 1-3 3-2, 3-3, 5-3, A-4 3-11 3-12 4-2, 5-1 C-1 to C-3	Remove style code Add Appendix C Change Introduction and add ATEX documentation Add a parameter Add Hardware Write Protect Function Change Sensor Trim procedure Add an error item New Publication

Written by Product Marketing Dept.
Transmitters Center
Industrial Automation Systems Business Div.
Yokogawa Electric Corporation

Published by Yokogawa Electric Corporation
2-9-32 Nakacho, Musashino-shi, Tokyo 180,
JAPAN
