



# ◆ Introduction

Thank you for purchasing the FLXA™ 202/FLXA™ 21 2-Wire Analyzer.

Please read the following respective documents before installing and using the FLXA202/FLXA21.

When the FLXA21 with the output of FOUNDATION Fieldbus or PROFIBUS PA Communication is used, please refer to the User's Manual, IM 12A01A02-71E or IM 12A01A02-72E, too.

The related documents are as follows.

## General Specifications

Contents	Document number	Note
FLXA202 2-wire Analyzer	GS 12A01A03-01EN	These are included In attached CD-ROM
FLXA21 2-wire Analyzer	GS 12A01A02-01E	
FLXA21 2-wire Analyzer FOUNDATION Fieldbus Communication	GS 12A01A02-71E	
FLXA21 2-wire Analyzer PROFIBUS PA Communication	GS 12A01A02-72E	

\* the "E" or "EN" in the document number is the language code.

## User's Manual

Contents	Document number	Note
FLXA202/FLXA21 Start-up Manual	IM 12A01A02-12E	Attached to the product
FLXA202/FLXA21 Safety Precautions	IM 12A01A02-20E	Attached to the product Note
FLXA202/FLXA21 User's Manual	IM 12A01A02-01E	This manual This is included In attached CD-ROM
FLXA21 FOUNDATION Fieldbus Communication	IM 12A01A02-71E	These are included In attached CD-ROM
FLXA21 PROFIBUS PA Communication	IM 12A01A02-72E	

\* the "E" in the document number is the language code.

Note: Please read the Safety Precautions (IM 12A01A02-20E) before using the product.

The Safety Precautions includes Control Drawings of intrinsic safety, nonincendive and Type n that describes specific condition for using FLXA202/FLXA21 in hazardous/classified location.

An exclusive User's Manual might be attached to the products whose suffix codes or option codes contain the code "Z" (made to customers' specifications). Please read it along with this manual.

## ■ Notes on Handling User's Manuals

- Please hand over the user's manuals to your end users so that they can keep the user's manuals on hand for convenient reference.
- Please read the information thoroughly before using the product.
- The purpose of these user's manuals is not to warrant that the product is well suited to any particular purpose but rather to describe the functional details of the product.
- No part of the user's manuals may be transferred or reproduced without prior written consent from YOKOGAWA.
- YOKOGAWA reserves the right to make improvements in the user's manuals and product at any time, without notice or obligation.
- If you have any questions, or you find mistakes or omissions in the user's manuals, please contact our sales representative or your local distributor.

## ■ Drawing Conventions

Some drawings may be partially emphasized, simplified, or omitted, for the convenience of description.

Some screen images depicted in the user's manual may have different display positions or character types (e.g., the upper / lower case). Also note that some of the images contained in this user's manual are display examples.

## ■ Composition of this User's Manual

The model FLXA202/FLXA21 2-Wire Analyzer offers 4 kinds of measurements – pH/ORP (oxidation-reduction potential), contacting conductivity (SC), inductive conductivity (ISC) or dissolved oxygen (DO) – with a respective sensor module.

The FLXA202/FLXA21 delivered has one specific kind of measurement depending on your order.

Contents	pH/ORP	Contacting conductivity (SC)	Inductive conductivity (ISC)	Dissolved oxygen (DO)	SENCOM™ pH/ORP
Introduction and general description	Section 1				
Wiring and installation	Section 2				
Operation	Section 3	Section 6	Section 9	Section 12	Section 15
Commissioning	Section 4	Section 7	Section 10	Section 13	Section 16
Calibration	Section 5	Section 8	Section 11	Section 14	Section 17
Maintenance	Section 18				
Troubleshooting	Section 19				

# ◆ Safety Precautions

## ■ Safety, Protection, and Modification of the Product

- In order to protect the system controlled by the product and the product itself and ensure safe operation, observe the safety precautions described in this user's manual. We assume no liability for safety if users fail to observe these instructions when operating the product.
- If this instrument is used in a manner not specified in this user's manual, the protection provided by this instrument may be impaired.
- If any protection or safety circuit is required for the system controlled by the product or for the product itself, prepare it separately.
- Be sure to use the spare parts approved by Yokogawa Electric Corporation (hereafter simply referred to as YOKOGAWA) when replacing parts or consumables.
- Modification of the product is strictly prohibited.
- The following safety symbols are used on the product as well as in this manual.



### WARNING

This symbol indicates that an operator must follow the instructions laid out in this manual in order to avoid the risks, for the human body, of injury, electric shock, or fatalities. The manual describes what special care the operator must take to avoid such risks.



### CAUTION

This symbol indicates that the operator must refer to the instructions in this manual in order to prevent the instrument (hardware) or software from being damaged, or a system failure from occurring.

### CAUTION

This symbol gives information essential for understanding the operations and functions.

### NOTE

This symbol indicates information that complements the present topic.



This symbol indicates Protective Ground Terminal.



This symbol indicates Function Ground Terminal. Do not use this terminal as the protective ground terminal.

## ■ Warning and Disclaimer

The product is provided on an "as is" basis. YOKOGAWA shall have neither liability nor responsibility to any person or entity with respect to any direct or indirect loss or damage arising from using the product or any defect of the product that YOKOGAWA can not predict in advance.



---

## ■ FLXA202/FLXA21

- The FLXA202/FLXA21 should only be used with equipment that meets the relevant IEC, American, Canadian, and Japanese standards. Yokogawa accepts no responsibility for the misuse of this unit.
- Don't install "general purpose type" instruments in the hazardous area.
- The Instrument is packed carefully with shock absorbing materials, nevertheless, the instrument may be damaged or broken if subjected to strong shock, such as if the instrument is dropped. Handle with care.

---

### CAUTION

#### Electrostatic discharge

The FLXA202/FLXA21 contains devices that can be damaged by electrostatic discharge.

When servicing this equipment, please observe proper procedures to prevent such damage.

Replacement components should be shipped in conductive packaging. Repair work should be done at grounded workstations using grounded soldering irons and wrist straps to avoid electrostatic discharge.

---

---

### CAUTION

- Do not use an abrasive or organic solvent in cleaning the instrument.
  - Substitution of components may impair suitability for Division 2.  
Do not remove or replace while circuit is live unless area is known to be non hazardous.  
Explosion Hazard – Do not disconnect equipment unless area is known to be non hazardous.  
Do not reset circuit breaker unless power has been removed from the equipment or the area is known to be non hazardous.
- 

---

### CAUTION

- This instrument is a EN61326-1 Class A product, and it is designed for use in the industrial environment. Please use this instrument in the industrial environment only.
  - The HART communication may be influenced by strong electromagnetic field.  
In this case another trial of the HART communication and/or operation with FLXA202/FLXA21 touch screen can be carried out.
- 

---

### CAUTION

When you open the front panel, make sure the screws are completely out of the screw holes, and then open the front panel slowly in order not to damage the threaded parts on the housing. If the threaded parts are damaged and the screws cannot be tightened, the waterproof performance will deteriorate.

---

---

### CAUTION

Be careful to touch the concentrated sulfuric acid.

---

## Mark position of explosion protected type

The mark position is shown as follows

### FLXA202

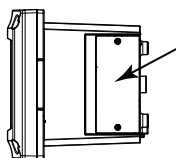
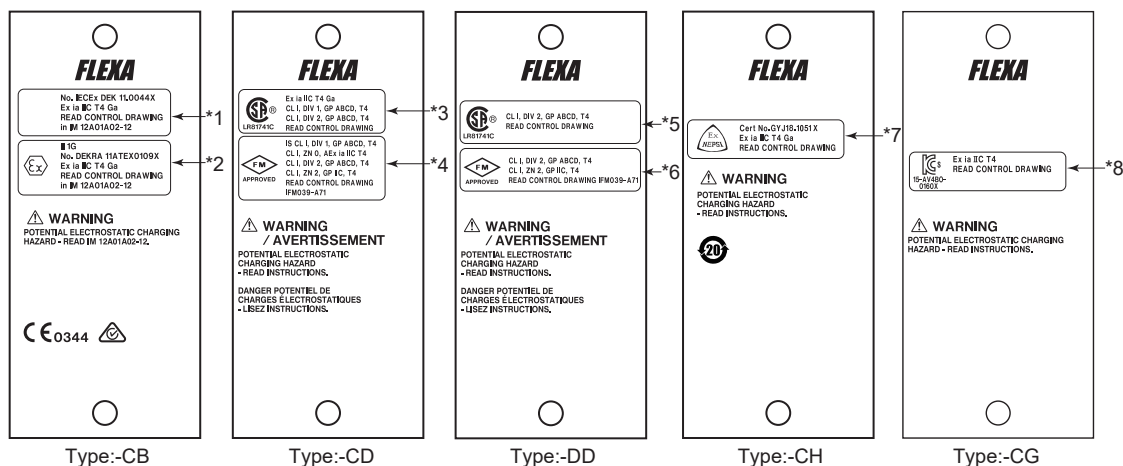

- \*1: This marking conforms to Intrinsic safety of IECEX.
- \*2: This marking conforms to Intrinsic safety of ATEX.
- \*3: This marking conforms to Intrinsic safety of CSA.
- \*4: This marking conforms to Intrinsic safety of FM.
- \*5: This marking conforms to nonincendive of FM.
- \*6: This marking conforms to nonincendive of FM.
- \*7: This marking conforms to Intrinsic safety of NEPSI.
- \*8: This marking conforms to Intrinsic safety of KOSHA.

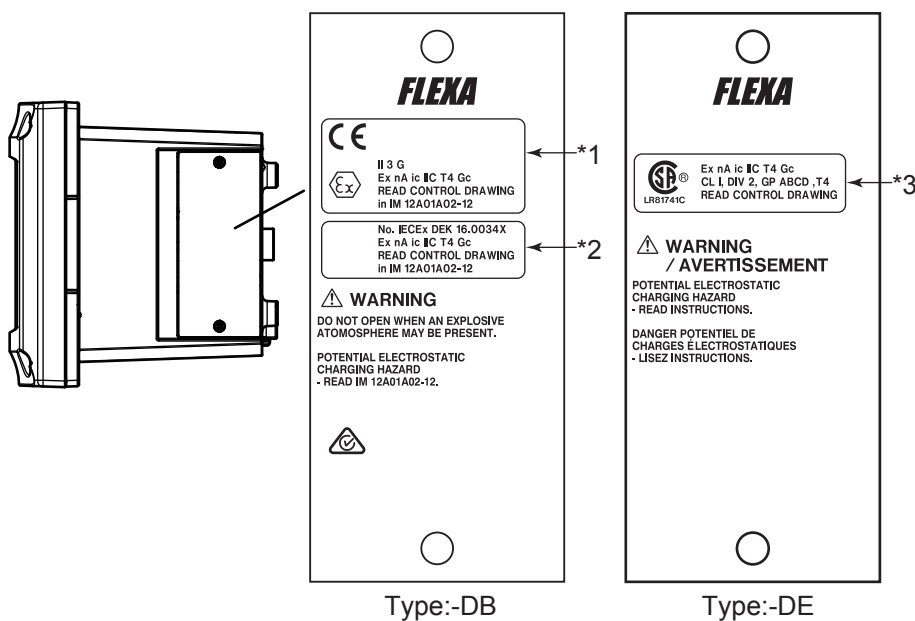

- \*1: This marking conforms to Type n of ATEX.
- \*2: This marking conforms to Type n of IECEX.
- \*3: This marking conforms to Type n of CSA.

● FLXA21 (Output: -A)

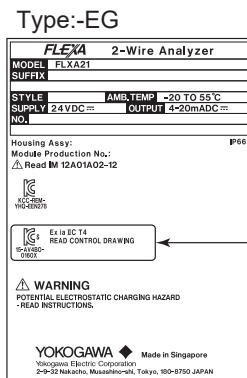
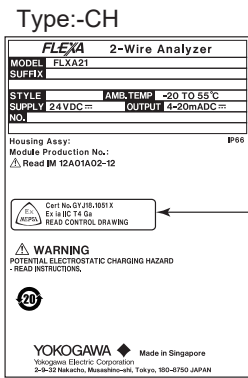
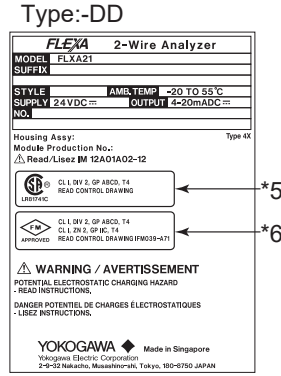
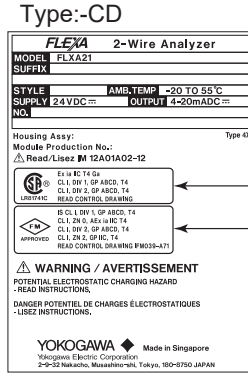
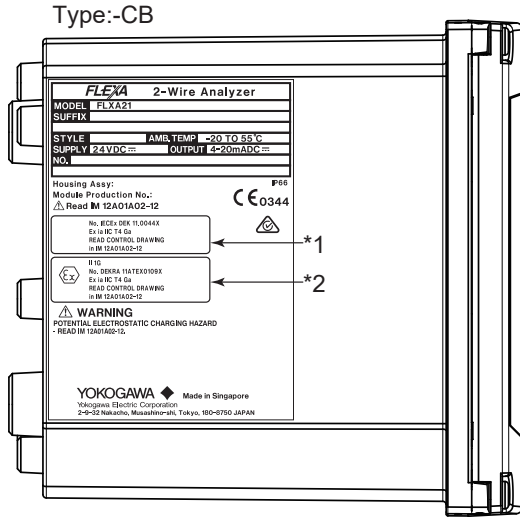

- \*1: This marking conforms to Intrinsic safety of IECEx.
- \*2: This marking conforms to Intrinsic safety of ATEX.
- \*3: This marking conforms to Intrinsic safety of CSA.
- \*4: This marking conforms to Intrinsic safety of FM.
- \*5: This marking conforms to nonincendive of CSA.
- \*6: This marking conforms to nonincendive of FM.
- \*7: This marking conforms to Intrinsic safety of NEPSI.
- \*8: This marking conforms to Intrinsic safety of KOSHA.

---

## ■ Product Disposal:

The instrument should be disposed of in accordance with local and national legislation/regulations.

## ■ Warranty and service

Yokogawa products and parts are guaranteed free from defects in workmanship and material under normal use and service for a period of (typically) 12 months from the date of shipment from the manufacturer.

Individual sales organisations can deviate from the typical warranty period, and the conditions of sale relating to the original purchase order should be consulted. Damage caused by wear and tear, inadequate maintenance, corrosion, or by the effects of chemical processes are excluded from this warranty coverage.

In the event of warranty claim, the defective goods should be sent (freight paid) to the service department of the relevant sales organisation for repair or replacement (at Yokogawa discretion). The following information must be included in the letter accompanying the returned goods:

- Part number, model code and serial number
- Original purchase order and date
- Length of time in service and a description of the process
- Description of the fault, and the circumstances of failure
- Process/environmental conditions that may be related to the failure of the device.
- A statement whether warranty or nonwarranty service is requested
- Complete shipping and billing instructions for return of material, plus the name and phone number of a contact person who can be reached for further information.

Returned goods that have been in contact with process fluids must be decontaminated/ disinfected before shipment. Goods should carry a certificate to this effect, for the health and safety of our employees.

Material safety data sheets should also be included for all components of the processes to which the equipment has been exposed.

---

## ■ Copyright and Trademark Notices

The copyrights of online manual contained in the CD-ROM are reserved.

The online manual is protected by the PDF security from modification, however, it can be output via a printer. Printing out the online manual is only allowed for the purpose of using the product. When using the printed information of the online manual, check if the version is the most recent one by referring to the CD-ROM's version.

No part of the online manual may be transferred, sold, distributed (including delivery via a commercial PC network or the like), or registered or recorded on video tapes.

FLEXA, FLXA, SENCOM and FieldMate are trademarks or registered trademarks of Yokogawa Electric Corporation.

Adobe, Acrobat and Acrobat Reader are either registered trademarks or trademarks of Adobe Systems Incorporated in the United States and/or other countries.

All other company and product names mentioned in this user's manual are trademarks or registered trademarks of their respective companies.

We do not use TM or ® mark to indicate those trademarks or registered trademarks in this user's manual.

### ● FLXA202/FLXA21's fonts

(c) Copyright 2000-2001 /efont/ The Electronic Font Open Laboratory. All rights reserved.

Redistribution and use in source and binary forms, with or without modification, are permitted provided that the following conditions are met:

1. Redistributions of source code must retain the above copyright notice, this list of conditions and the following disclaimer.
2. Redistributions in binary form must reproduce the above copyright notice, this list of conditions and the following disclaimer in the documentation and/or other materials provided with the distribution.
3. Neither the name of the team nor the names of its contributors may be used to endorse or promote products derived from this font without specific prior written permission.

THIS FONT IS PROVIDED BY THE TEAM AND CONTRIBUTORS "AS IS" AND ANY EXPRESS OR IMPLIED WARRANTIES, INCLUDING, BUT NOT LIMITED TO, THE IMPLIED WARRANTIES OF MERCHANTABILITY AND FITNESS FOR A PARTICULAR PURPOSE ARE DISCLAIMED. IN NO EVENT SHALL THE TEAM OR CONTRIBUTORS BE LIABLE FOR ANY DIRECT, INDIRECT, INCIDENTAL, SPECIAL, EXEMPLARY, OR CONSEQUENTIAL DAMAGES (INCLUDING, BUT NOT LIMITED TO, PROCUREMENT OF SUBSTITUTE GOODS OR SERVICES; LOSS OF USE, DATA, OR PROFITS; OR BUSINESS INTERRUPTION) HOWEVER CAUSED AND ON ANY THEORY OF LIABILITY, WHETHER IN CONTRACT, STRICT LIABILITY, OR TORT (INCLUDING NEGLIGENCE OR OTHERWISE) ARISING IN ANY WAY OUT OF THE USE OF THIS FONT, EVEN IF ADVISED OF THE POSSIBILITY OF SUCH DAMAGE.

---

# ◆ CE marking products

## ■ Authorised Representative in EEA

The Authorised Representative for this product in EEA is Yokogawa Europe B.V. (Euroweg 2, 3825 HD Amersfoort, The Netherlands).

## ■ Identification Tag

This manual and the identification tag attached on a packing box are essential parts of the product.

Keep them together in a safe place for future reference.

## ■ Users

This product is designed to be used by a person with specialized knowledge.

## ■ How to dispose the batteries:

This is an explanation about the EU Battery Directive. This directive is only valid in the EU.

Batteries are included in this product. Batteries incorporated into this product cannot be removed by yourself. Dispose them together with this product.

When you dispose this product in the EU, contact your local Yokogawa Europe B.V.office. Do not dispose them as domestic household waste.

Battery type: Manganese dioxide lithium battery



Notice:

The symbol (see above) means they shall be sorted out and collected as ordained in the EU Battery Directive.

## ■ Information of the WEEE Directive

This product is purposely designed to be used in a large scale fixed installations only and, therefore, is out of scope of the WEEE Directive. The WEEE Directive does not apply. This product should be disposed in accordance with local and national legislation/regulations.

The WEEE Directive is only valid in the EU.

---

Blank Page

# Model FLXA202 / FLXA21

## 2-Wire Analyzer

IM 12A01A02-01E 9th Edition

## CONTENTS

◆	Introduction.....	i
◆	Safety Precautions .....	iii
◆	CE marking products .....	ix
1.	<b>INTRODUCTION AND GENERAL DESCRIPTION.....</b>	<b>1-1</b>
	1.1 Instrument check .....	1-3
	1.2 Screen operation.....	1-6
	1.3 Passwords .....	1-11
	1.4 Regulatory Compliance.....	1-11
	1.5 Model & Suffix Codes .....	1-16
2.	<b>WIRING AND INSTALLATION .....</b>	<b>2-1</b>
	2.1 Installation site .....	2-3
	2.2 Removing the wiring cover .....	2-4
	2.3 Installing the cable glands .....	2-5
	2.4 Wiring the power supply .....	2-7
	2.4.1 Grounding .....	2-8
	2.4.2 Connection of the power supply .....	2-8
	2.4.3 Wiring cover .....	2-9
	2.5 Sensor wiring .....	2-10
	2.5.1 Wiring the pH/ORP sensor .....	2-14
	2.5.2 Wiring the conductivity (SC) sensor.....	2-17
	2.5.3 Wiring the inductive conductivity (ISC) sensor .....	2-17
	2.5.4 Wiring the dissolved oxygen (DO) sensor .....	2-18
	2.5.5 Wiring the SENCOM pH/ORP sensor .....	2-18
	2.6 Mounting methods.....	2-19
	2.7 Operation .....	2-20
3.	<b>OPERATION OF pH/ORP .....</b>	<b>3-1</b>
	3.1 Change language .....	3-2
	3.2 Quick setup.....	3-2
	3.3 Home display, Main display and Monitor display.....	3-4
	3.4 Zooming in on details .....	3-5
	3.5 Trend graphics .....	3-10
	3.6 Instrument status screen .....	3-11
	3.7 Calibration and Commissioning .....	3-12
4.	<b>COMMISSIONING OF pH/ORP .....</b>	<b>4-1</b>



---

<b>4.1</b>	<b>Sensor setup</b> .....	<b>4-3</b>
<b>4.2</b>	<b>Measurement setup</b> .....	<b>4-3</b>
4.2.1	Measurement .....	4-3
4.2.2	Temperature settings .....	4-4
4.2.3	Temperature compensation .....	4-4
4.2.4	Calibration settings .....	4-5
4.2.5	Impedance settings .....	4-8
4.2.6	Concentration .....	4-8
4.2.7	Sensor diagnostic settings .....	4-9
<b>4.3</b>	<b>Output setup</b> .....	<b>4-9</b>
<b>4.4</b>	<b>Error configuration</b> .....	<b>4-11</b>
<b>4.5</b>	<b>Logbook configuration</b> .....	<b>4-13</b>
<b>4.6</b>	<b>Advanced setup</b> .....	<b>4-13</b>
4.6.1	Settings .....	4-13
4.6.2	Tag .....	4-14
4.6.3	Passwords .....	4-14
4.6.4	Date/Time .....	4-14
4.6.5	Communication .....	4-14
4.6.6	Factory setup .....	4-17
<b>4.7</b>	<b>Display setup</b> .....	<b>4-17</b>
4.7.1	Main display (Dual display, Individual display) .....	4-18
4.7.2	Trend .....	4-19
4.7.3	Auto Return .....	4-19
4.7.4	Adjust contrast .....	4-19
4.7.5	MONITOR display .....	4-19
<b>4.8</b>	<b>Calculated data setup</b> .....	<b>4-20</b>
<b>5.</b>	<b>CALIBRATION OF pH/ORP</b> .....	<b>5-1</b>
<b>5.1</b>	<b>pH calibration</b> .....	<b>5-2</b>
5.1.1	Manual calibration .....	5-2
5.1.2	Automatic calibration .....	5-3
5.1.3	Sample calibration .....	5-5
<b>5.2</b>	<b>Temperature calibration</b> .....	<b>5-5</b>
<b>5.3</b>	<b>ORP calibration (rH calibration)</b> .....	<b>5-5</b>
<b>5.4</b>	<b>HOLD</b> .....	<b>5-6</b>
<b>5.5</b>	<b>Temporary output</b> .....	<b>5-6</b>
<b>6.</b>	<b>OPERATION OF SC (Conductivity)</b> .....	<b>6-1</b>
<b>6.1</b>	<b>Change language</b> .....	<b>6-1</b>
<b>6.2</b>	<b>Quick setup</b> .....	<b>6-2</b>
<b>6.3</b>	<b>Home display, Main display and Monitor display</b> .....	<b>6-4</b>
<b>6.4</b>	<b>Zooming in on details</b> .....	<b>6-6</b>
<b>6.5</b>	<b>Trend graphics</b> .....	<b>6-10</b>
<b>6.6</b>	<b>Instrument status screen</b> .....	<b>6-11</b>
<b>6.7</b>	<b>Calibration and Commissioning</b> .....	<b>6-11</b>

---

---

<b>7.</b>	<b>COMMISSIONING OF SC (Conductivity)</b> .....	<b>7-1</b>
7.1	Measurement setup .....	7-3
7.1.1	Measurement .....	7-3
7.1.2	Configure sensor .....	7-3
7.1.3	Temperature settings .....	7-3
7.1.4	Temperature compensation .....	7-4
7.1.5	Calibration settings .....	7-5
7.1.6	Concentration .....	7-5
7.1.7	Sensor diagnostic settings .....	7-6
7.2	Output setup .....	7-6
7.3	Error configuration .....	7-9
7.4	Logbook configuration .....	7-10
7.5	Advanced setup .....	7-11
7.5.1	Settings .....	7-11
7.5.2	Tag .....	7-11
7.5.3	Passwords .....	7-12
7.5.4	Date/Time .....	7-12
7.5.5	Communication .....	7-12
7.5.6	Factory setup .....	7-13
7.6	Display setup .....	7-13
7.6.1	Main display (Dual display, Individual display) .....	7-13
7.6.2	Trend .....	7-14
7.6.3	Auto Return .....	7-15
7.6.4	Adjust contrast .....	7-15
7.6.5	MONITOR display .....	7-15
7.7	Calculated data setup .....	7-15
<b>8.</b>	<b>CALIBRATION OF SC (Conductivity)</b> .....	<b>8-1</b>
8.1	Cell constant (manual) .....	8-2
8.2	Cell constant (automatic) .....	8-2
8.3	Air calibration .....	8-2
8.4	Sample .....	8-2
8.5	Temperature coefficient .....	8-3
8.6	Temperature calibration .....	8-3
8.7	HOLD .....	8-3
8.8	Temporary output .....	8-4
<b>9.</b>	<b>OPERATION OF ISC (Inductive Conductivity)</b> .....	<b>9-1</b>
9.1	Change language .....	9-2
9.2	Quick setup .....	9-2
9.3	Main display and Monitor display .....	9-4
9.4	Zooming in on details .....	9-5
9.5	Trend graphics .....	9-9
9.6	Instrument status screen .....	9-11
9.7	Calibration and Commissioning .....	9-11

---

---

<b>10.</b>	<b>COMMISSIONING OF ISC (Inductive Conductivity)</b> .....	<b>10-1</b>
<b>10.1</b>	<b>Measurement setup</b> .....	<b>10-2</b>
10.1.1	Measurement .....	10-3
10.1.2	Configure sensor .....	10-3
10.1.3	Temperature settings .....	10-3
10.1.4	Temperature compensation .....	10-3
10.1.5	Calibration settings .....	10-4
10.1.6	Concentration .....	10-5
10.1.7	Sensor diagnostic settings .....	10-6
<b>10.2</b>	<b>Output setup</b> .....	<b>10-6</b>
<b>10.3</b>	<b>Error configuration</b> .....	<b>10-7</b>
<b>10.4</b>	<b>Logbook configuration</b> .....	<b>10-8</b>
<b>10.5</b>	<b>Advanced setup</b> .....	<b>10-9</b>
10.5.1	Settings .....	10-9
10.5.2	Tag .....	10-9
10.5.3	Passwords .....	10-10
10.5.4	Date/Time .....	10-10
10.5.5	Communication .....	10-10
10.5.6	Factory setup .....	10-11
<b>10.6</b>	<b>Display setup</b> .....	<b>10-11</b>
10.6.1	Main display .....	10-11
10.6.2	Trend .....	10-11
10.6.3	Auto Return .....	10-12
10.6.4	Adjust contrast .....	10-12
10.6.5	MONITOR display .....	10-12
<b>11.</b>	<b>CALIBRATION OF ISC (Inductive Conductivity)</b> .....	<b>11-1</b>
<b>11.1</b>	<b>Cell constant (manual)</b> .....	<b>11-3</b>
<b>11.2</b>	<b>Cell constant (automatic)</b> .....	<b>11-3</b>
<b>11.3</b>	<b>Air calibration</b> .....	<b>11-3</b>
<b>11.4</b>	<b>Sample</b> .....	<b>11-4</b>
<b>11.5</b>	<b>Temperature coefficient</b> .....	<b>11-4</b>
<b>11.6</b>	<b>Temperature calibration</b> .....	<b>11-5</b>
<b>11.7</b>	<b>HOLD</b> .....	<b>11-5</b>
<b>12.</b>	<b>OPERATION OF DO (Dissolved Oxygen)</b> .....	<b>12-1</b>
<b>12.1</b>	<b>Change language</b> .....	<b>12-2</b>
<b>12.2</b>	<b>Quick setup</b> .....	<b>12-2</b>
<b>12.3</b>	<b>Home display, Main display and Monitor display</b> .....	<b>12-4</b>
<b>12.4</b>	<b>Zooming in on details</b> .....	<b>12-5</b>
<b>12.5</b>	<b>Trend graphics</b> .....	<b>12-9</b>
<b>12.6</b>	<b>Instrument status screen</b> .....	<b>12-10</b>
<b>12.7</b>	<b>Calibration and Commissioning</b> .....	<b>12-10</b>
<b>13.</b>	<b>COMMISSIONING OF DO (Dissolved Oxygen)</b> .....	<b>13-1</b>
<b>13.1</b>	<b>Sensor setup</b> .....	<b>13-2</b>

---

---

<b>13.2</b>	<b>Measurement setup</b> .....	<b>13-3</b>
13.2.1	Sensor setup .....	13-3
13.2.2	Temperature settings .....	13-3
13.2.3	Temperature compensation .....	13-3
13.2.4	Salinity compensation .....	13-3
13.2.5	Pressure comp. (Measure) .....	13-3
13.2.6	Calibration settings .....	13-4
13.2.7	Sensor diag. settings .....	13-5
<b>13.3</b>	<b>Output setup</b> .....	<b>13-5</b>
<b>13.4</b>	<b>Error configuration</b> .....	<b>13-7</b>
<b>13.5</b>	<b>Logbook configuration</b> .....	<b>13-8</b>
<b>13.6</b>	<b>Advanced setup</b> .....	<b>13-9</b>
13.6.1	Settings .....	13-9
13.6.2	Tag .....	13-9
13.6.3	Passwords .....	13-10
13.6.4	Date/Time .....	13-10
13.6.5	Communication .....	13-10
13.6.6	Factory setup .....	13-12
<b>13.7</b>	<b>Display setup</b> .....	<b>13-12</b>
13.7.1	Main display (Dual display, Individual display) .....	13-12
13.7.2	Trend .....	13-13
13.7.3	Auto Return .....	13-14
13.7.4	Adjust contrast .....	13-14
13.7.5	MONITOR display .....	13-14
<b>13.8</b>	<b>Calculated data setup</b> .....	<b>13-14</b>
<b>14.</b>	<b>CALIBRATION OF DO (Dissolved Oxygen)</b> .....	<b>14-1</b>
14.1	Air calibration .....	14-2
14.2	Water calibration .....	14-2
14.3	Manual slope calibration .....	14-3
14.4	Temperature calibration .....	14-3
14.5	HOLD .....	14-4
14.6	Temporary output .....	14-4
<b>15.</b>	<b>OPERATION OF SENCOM pH/ORP</b> .....	<b>15-1</b>
15.1	Change language .....	15-2
15.2	Quick setup .....	15-2
15.3	Main display and Monitor display .....	15-4
15.4	Zooming in on details .....	15-5
15.5	Trend graphics .....	15-12
15.6	Instrument status screen .....	15-13
15.7	Calibration and Commissioning .....	15-13
<b>16.</b>	<b>COMMISSIONING OF SENCOM pH/ORP</b> .....	<b>16-1</b>
16.1	Sensor setup .....	16-3
16.2	Measurement setup .....	16-4

---

16.2.1	Measurement.....	16-4
16.2.2	Temperature settings .....	16-4
16.2.3	Temperature compensation .....	16-4
16.2.4	Calibration settings .....	16-6
16.2.5	Impedance settings.....	16-9
16.2.6	Concentration.....	16-9
16.2.7	Sensor diagnostic settings.....	16-9
<b>16.3</b>	<b>Output setup.....</b>	<b>16-10</b>
<b>16.4</b>	<b>Error configuration .....</b>	<b>16-11</b>
<b>16.5</b>	<b>Logbook configuration.....</b>	<b>16-12</b>
<b>16.6</b>	<b>Advanced setup .....</b>	<b>16-13</b>
16.6.1	Settings .....	16-13
16.6.2	Tag.....	16-14
16.6.3	Passwords .....	16-14
16.6.4	Date/Time.....	16-14
16.6.5	Communication.....	16-14
16.6.6	Factory setup .....	16-17
<b>16.7</b>	<b>Display setup.....</b>	<b>16-17</b>
16.7.1	Main display .....	16-17
16.7.2	Trend.....	16-18
16.7.3	Auto Return .....	16-18
16.7.4	Adjust contrast .....	16-18
16.7.5	MONITOR display.....	16-18
<b>17.</b>	<b>CALIBRATION OF SENCOR pH/ORP.....</b>	<b>17-1</b>
<b>17.1</b>	<b>pH calibration .....</b>	<b>17-2</b>
17.1.1	Manual calibration.....	17-2
17.1.2	Automatic calibration.....	17-3
17.1.3	Sample calibration .....	17-5
<b>17.2</b>	<b>Temperature calibration .....</b>	<b>17-5</b>
<b>17.3</b>	<b>ORP calibration (rH calibration) .....</b>	<b>17-5</b>
<b>17.4</b>	<b>HOLD .....</b>	<b>17-6</b>
<b>18.</b>	<b>MAINTENANCE.....</b>	<b>18-1</b>
<b>19.</b>	<b>TROUBLESHOOTING .....</b>	<b>19-1</b>
<b>Appendix 1</b>	<b>For pH/ORP .....</b>	<b>App.1-1</b>
<b>Appendix 2</b>	<b>For SC (Conductivity) .....</b>	<b>App.2-1</b>
<b>Appendix 3</b>	<b>For ISC (Inductive Conductivity) .....</b>	<b>App.3-1</b>
<b>Appendix 4</b>	<b>For DO (Dissolved Oxygen) .....</b>	<b>App.4-1</b>
<b>Appendix 5</b>	<b>Control Drawings .....</b>	<b>App.5-1</b>
App. 5.1	ATEX and IECEx FLXA202/FLXA21: Intrinsic safety “ia” .....	App.5-1
App. 5.2	CSA FLXA202/FLXA21: Intrinsic safety, Nonincendive, FLXA202: Type of protection ‘n’ .....	App.5-3

---

App. 5.3 FM	
FLXA202/FLXA21: Intrinsic safety, Nonincendive.....	App.5-7
App. 5.4 ATEX (Type n)	
FLXA202: Type of protection ‘n’ .....	App.5-10
App. 5.5 IECEEx (Type n)	
FLXA202: Type of protection ‘n’ .....	App.5-12
App. 5.6 NEPSI and KOSHA	
FLXA202/FLXA21: Intrinsic safety “ia” .....	App.5-14
<b>Customer Maintenance Parts List.....</b>	<b>CMPL 12A01A02-01E</b>
<b>Customer Maintenance Parts List.....</b>	<b>CMPL 12A01A03-01EN</b>
<b>Revision Record.....</b>	<b>i</b>



# 1. INTRODUCTION AND GENERAL DESCRIPTION

This manual describes how to use the FLXA202/FLXA21 with Yokogawa's or other companies' sensors. Please read carefully this manual and the instruction manual of the relevant sensor before using this instrument.

For the specifications of the FLXA202/FLXA21, please refer to the General Specifications (GS 12A01A02-01E) in the attached CD-ROM.

The FLXA202/FLXA21 2-Wire Analyzer can perform 4 kinds of measurements – pH/ORP (oxidation-reduction potential), contacting conductivity (SC), inductive conductivity (ISC) or dissolved oxygen (DO) – with the respective sensor module.

For the pH/ORP measurement, the FLXA202/FLXA21 can be connected to conventional analog pH/ORP sensors, and to Yokogawa's digital sensor, FU20F pH/ORP SENCOM Sensor with the respective sensor module.

The FLXA202/FLXA21 can perform single or dual sensor measurement. For dual sensor measurement, the combination of two same type sensor inputs – pH/ORP and pH/ORP (analog sensor only), SC and SC, and DO and DO –are available with two sensor modules.

When using with the pH/ORP SENCOM sensor, please refer to the section 15, 16 and 17 of this manual for the operation, commissioning and calibration respectively.

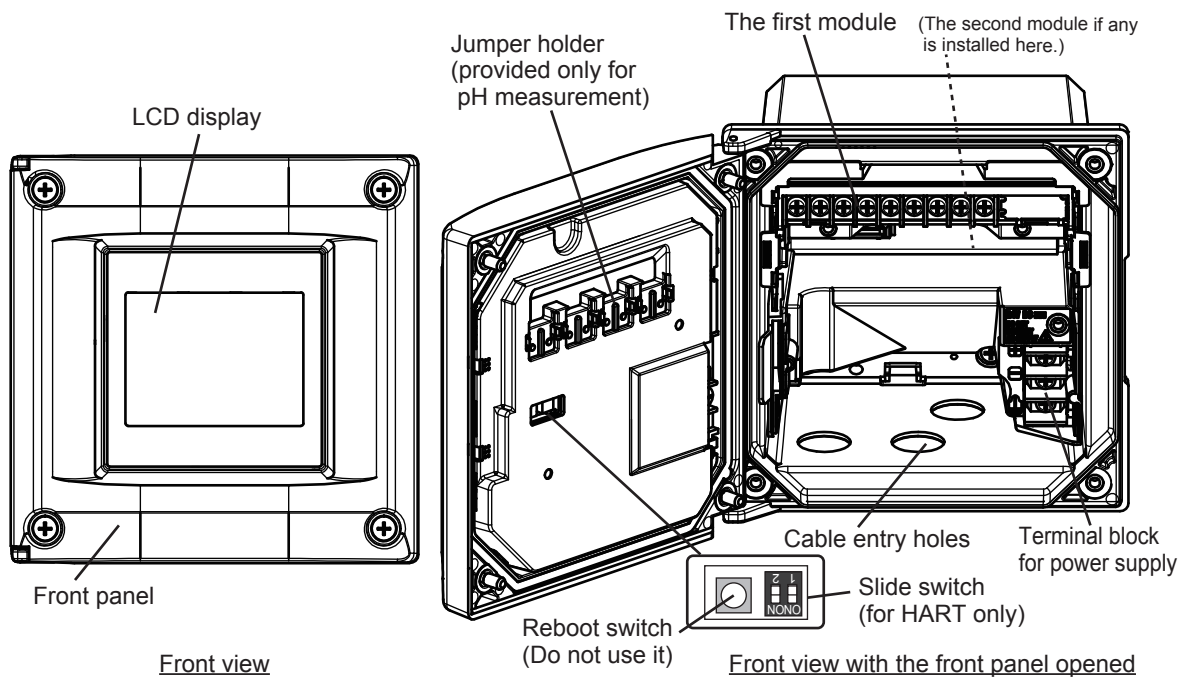

Figure 1.1 FLXA202 Parts names and descriptions

- PH
- SC
- ISC
- DO
- SENCOM



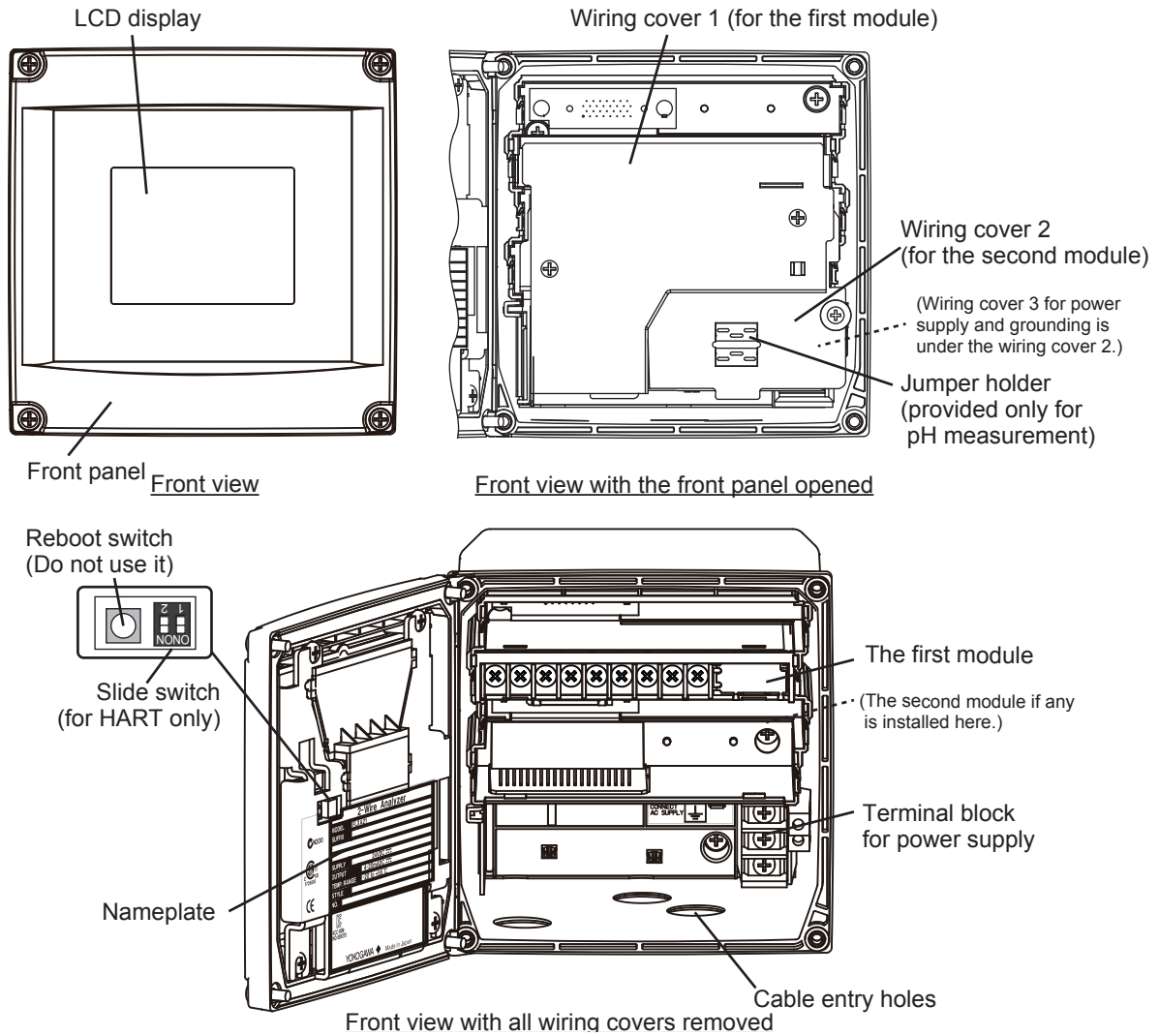

Figure 1.2 FLXA21 Parts names and descriptions

## 1.1 Instrument check

Upon delivery, unpack the instrument carefully and inspect it to ensure that it was not damaged during shipment. If damage is found, retain the original packing materials (including the outer box) and then immediately notify the carrier and the relevant Yokogawa sales office.

1

### ■ Checking the model and suffix code

#### ● FLXA202

Make sure the model and suffix code on the nameplate affixed to the left side of the housing. Refer to Section 1.5.

#### NOTE

Be sure to apply correct power to the unit, as detailed on the nameplate.

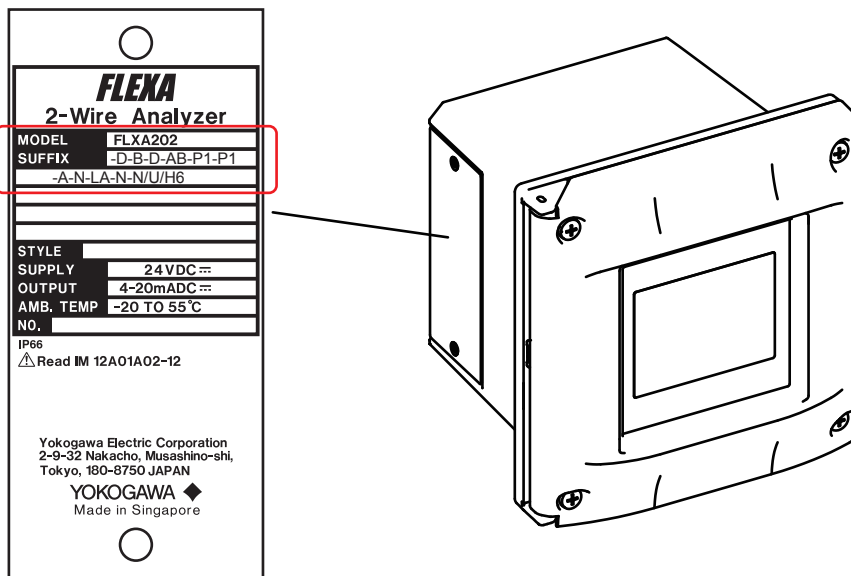

Figure 1.3 Example of nameplate (FLXA202)

#### ● FLXA21

Loosen four front panel screws of the FLXA21, open the panel to the left, and make sure the model and suffix code on the nameplate affixed to the left side or inside of the housing agrees with your order. Refer to Section 1.5.

#### CAUTION

When you open the front panel, make sure the screws are completely out of the screw holes, and then open the front panel slowly in order not to damage the threaded parts on the housing. If the threaded parts are damaged and the screws cannot be tightened, the waterproof performance will deteriorate.

#### NOTE

Be careful not to lose the four front panel screws.

PH

SC

ISC

DO

SENCOM

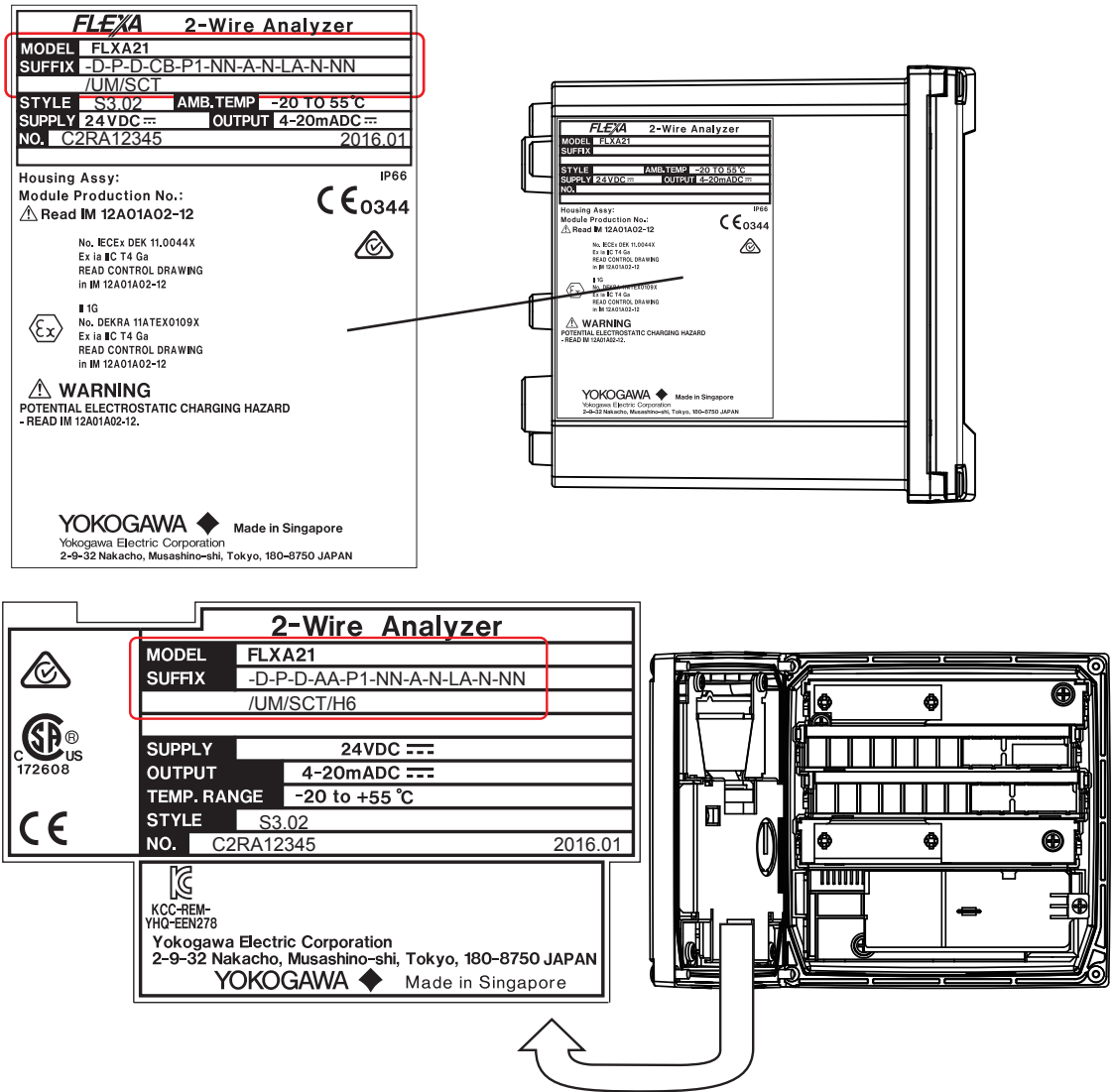

Figure 1.4 Example of nameplate (FLXA21)

● **Checking the accessories**

Make sure the accessories in Table 1.1 are included.

**Table 1.1 Accessories**

Product Name		Quantity	Remark
Cable glands	FLXA202	3 sets	One rubber plug attachment.
	FLXA21	3 or 4 sets	4 sets when 2 sensors are used. One grommet for grounding attachment.
pH analyzer	Jumper	2 pcs/module	
	Grommet set	1 set/module	
SENCOM pH analyzer	Grommet	1	
Option	Bracket	1 set	Option code /UM*, /U, /PM
	Sun shade hood	1 set	Option code /H6, /H7, /H8
	Tag plate	1	Option code /SCT
	Adapter for conduit work	3 or 4 sets	Option code /CB4, /CD4, /CF4 4 sets when FLXA21 are used.
Instruction Manual (CD-ROM)		1 copy	
Startup Manual		1 copy	
Safety Precautions		1 copy	

\*: The universal mounting kit (/UM) contains the brackets for both /U and /PM options.

**NOTE**

Rule of The Serial Number is as follows.

The Serial Number is defined by nine (9) alphanumeric characters as follows.

$X_1X_2Y_3M_4N_5N_6N_7N_8N_9$  e.g. 92NA07704

- $X_1X_2$ : Production Site
- $Y_3M_4$ : Year/Month code
- $N_5N_6N_7N_8N_9$ : Tracking number

**Table 1.2 Production year code**

Year	Year code	Year	Year code	Year	Year code	Year	Year code
2010	K	2015	R	2020	W	2025	2
2011	L	2016	S	2021	X	2026	3
2012	M	2017	T	2022	Y	2027	4
2013	N	2018	U	2023	Z	2028	5
2014	P	2019	V	2024	1	2029	6

**Table 1.3 Production month code**

Month	Month code	Month	Month code	Month	Month code
January	1	May	5	September	9
February	2	June	6	October	A
March	3	July	7	November	B
April	4	August	8	December	C

## 1.2 Screen operation

### CAUTION

Press the touch screen only with your finger. Do not use a tool with a sharp tip (ex. pencil, ballpoint pen), a thin stick, a tool with a hard tip etc. to avoid scratches on the touch screen.

Press the center of the icon or character to avoid wrong operation.

The main screen operations are as follows.

When you press any of the following icons on the screen, the screen changes to the respective display or executes the respective function.



Returns to the main display (or home display).



Returns to the previous display.



Moves the cursor for selecting the menu item. Pressing the icon moves the cursor down to the next item. When the cursor is on the item at the very bottom, the cursor jumps back to the item at the top.



Confirms the input; for example, the selected menu item or setting value.

### NOTE

When no operation is performed for 10 minutes or 60 minutes (depending on the setting of “Auto Return”), the display except Trend display automatically changes to the Monitor display (or to the Main display or the Home display when the MONITOR display is disabled).

The figures in this section show the pH measurement for example.

Each display is different in details due to settings. Each display is only an example for some settings.

### ■ Monitor display

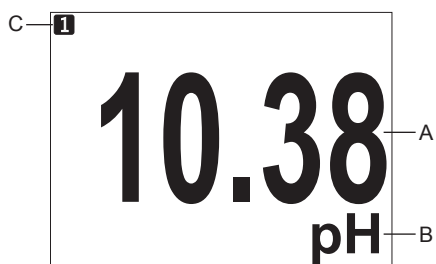

Figure 1.5 Example of monitor display

#### Monitor display

The Monitor display appears upon startup when the MONITOR display is enabled.

When the measurement value (primary value) on the main or home display is pressed, the monitor display appears.

- A: Measurement value
- B: Unit
- C: Sensor No.

**Main display**

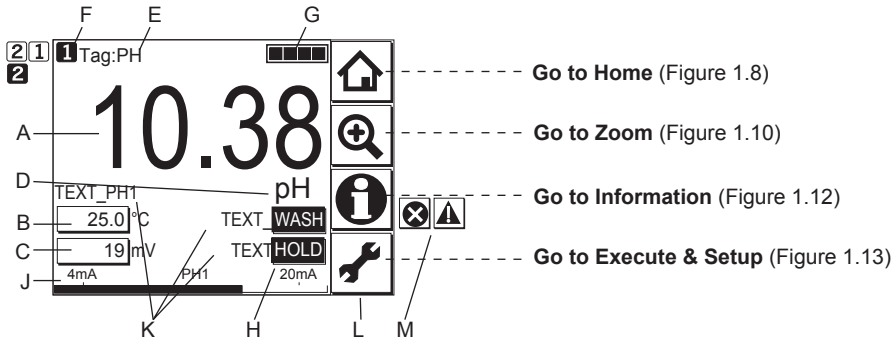

Figure 1.6 Example of main display

**Main display**

The Main display appears upon startup when one sensor is connected and the MONITOR display is disabled.

- A: Measurement value: Primary value (large characters/user selectable)
- B, C: Measurement value: Second and tertiary values (small characters)
- D: Unit for the primary value
- E: Tag No. (user programmable)
- F: Sensor No. \*
- G: Sensor wellness indicator (More ■ indicate the better condition.)
- H: Hold/Wash indicators (appear only during the Hold/Wash operations)
- J: Analog output display and parameter \* (ex.: PH1...PH=Parameter, 1=sensor number)
- K: Additional text (set in alphanumeric characters/user programmable)
- L: Function buttons (Home, Zoom, Status, Execute & Setup)
- M: Fault/Warning indicators (indicated in blinking only during Fault/Warning status)

\* When the parameter of which measurement value is indicated is selected as a process parameter, that is, mA output set on the Output setup (refer to the section 5.3, 8.2, 11.2, and 14.3), its Sensor No. is indicated as a white number in the black box, for example 1, and its mA output is indicated as a bar at the bottom. At the bar, a parameter symbol is indicated.

**NOTE**

Measurement values on the display can be set independent of the process parameter.

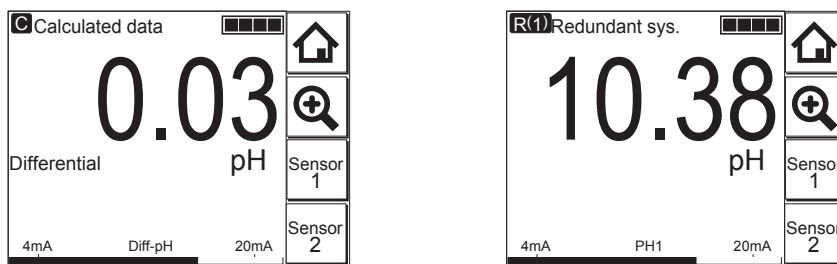

Figure 1.7 Example of calculated data and redundant system

■ Home display (when two sensors are connected)

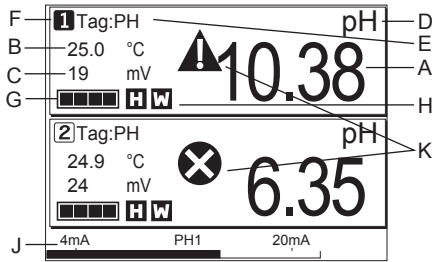

Figure 1.8 Example of home display

Home display

The Home display appears upon startup when two sensors are connected and the MONITOR display is disabled.

(Home display is not available when only one sensor is connected)

- A: Measurement value: Primary value (large characters/user selectable)
- B, C: Measurement value: Secondary and tertiary values (small characters)
- D: Unit for the primary value
- E: Tag No. (user programmable)
- F: Sensor No.
- G: Sensor wellness indicator (More ■ indicate the better condition.)
- H: Hold/Wash indicators (appear only during the Hold/Wash operations)
- J: Analog output display and parameter (ex.: PH1...PH=Parameter, 1=sensor number)
- K: Fault/Warning indicators (indicated in blinking only during Fault/Warning status)

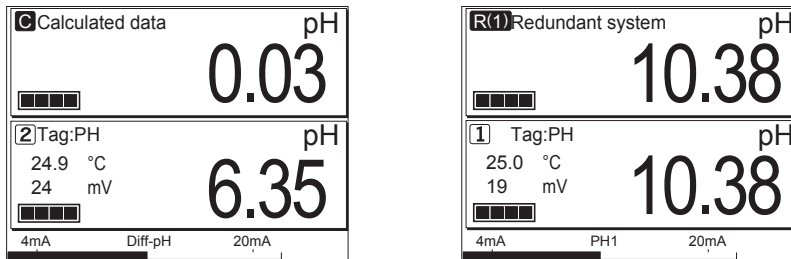

Figure 1.9 Example of home display of calculated data and redundant system

■ Zoom display

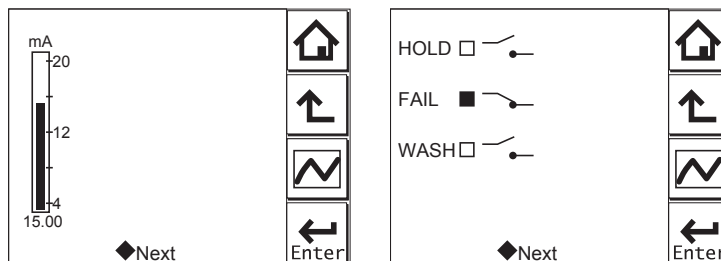

Figure 1.10 Example zoom display

The zoom display appears when the Zoom button on the main display is pressed.

The Zoom display shows an easy-to-read graphical display of the output status. Pressing Next displays the contact state if communication is set to PH201G distributor. Pressing Next again displays the status information of the instrument.

■ Trend display 

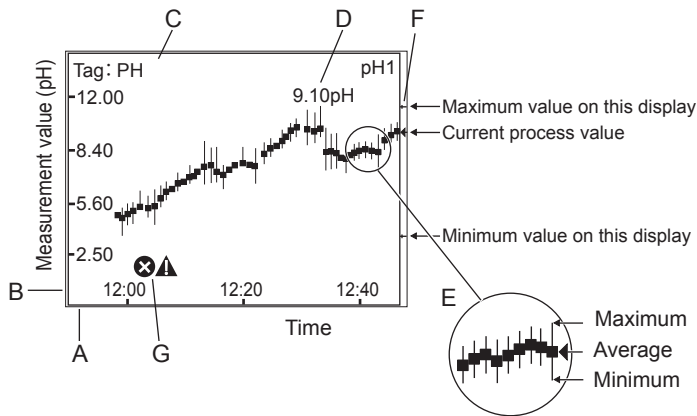

Figure 1.11 Example of trend display

**Trend display**

The Trend display appears when the Trend button on the Zoom display is pressed.

- A: X axis; Time axis (user programmable from 15 minutes to 14 days)
- B: Y axis; Measurement value axis (user programmable)
- C: Tag No.
- D: Current measurement value with unit
- E: Trend (maximum, minimum and average values during the display update time)
- F: Icon (current measurement value, and maximum and minimum values until the display update)
- G: Fault/Warning indicators (indicated in blinking only during Fault/Warning status)

- PH
- SC
- ISC
- DO
- SENCOM



## ■ Information button

Diagnosis information on converters and sensors appears.



No malfunction detected.



Warning

When a warning icon appears, maintenance is required. Pressing this icon displays an error message, and pressing the message displays the troubleshooting guidelines.



Fault

This icon indicates a malfunction. Pressing this icon displays an error message, and pressing the message displays the troubleshooting guidelines.

For some errors concerned with setting, a message on the remedy can jump to the relevant setting directly.

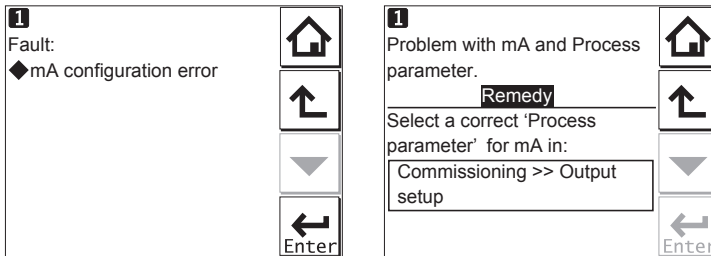

Figure 1.12 Example of jumping from remedy to setting

If neither a fault is detected nor warning is indicated, “Working properly” is displayed.

If a fault is detected or warning is indicated, up to 3 messages appear.

## ■ Execute & Setup

Allows you to calibrate and configure the instrument. These operations can be protected with a password.

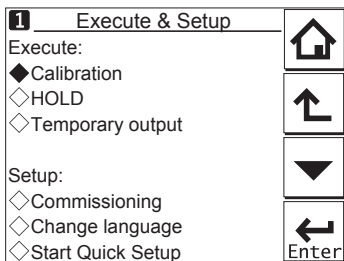

Figure 1.13 Example of Execute & Setup display

# 1.3 Passwords

Passwords can protect the FLXA202/FLXA21 from other persons' access except a right operator's.

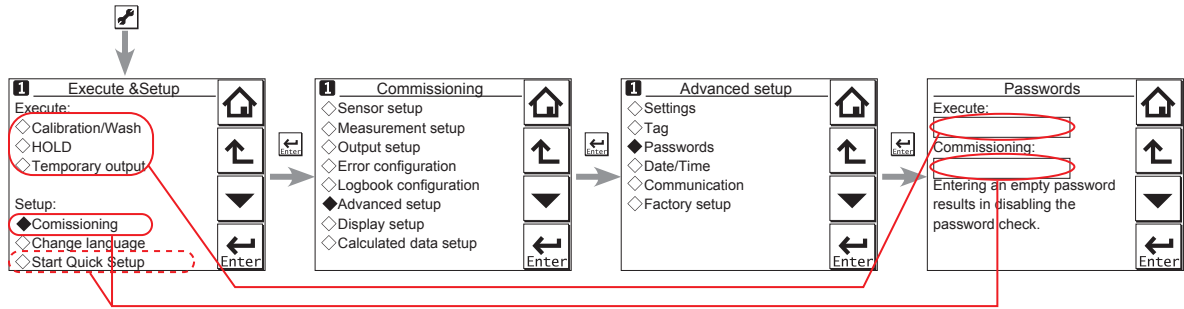

Figure 1.14 Example of passwords setting

Execute operation and Commissioning operation can be separately protected by each password. When the Execute password is set, execution of Calibration(/Wash), HOLD or Temporary output needs to enter the password to start each execution. When the Commissioning password is set, Commissioning and Start Quick Setup needs to enter the password to start the setting-up.

Refer to the section 4.6.3, 7.5.3, 10.5.3, 13.6.3 or 16.6.3 for details of setting passwords.

# 1.4 Regulatory Compliance

- Safety, EMC and RoHS Compliance (FLXA202/FLXA21)

Safety: UL 61010-1  
 UL 61010-2-030  
 CAN/CSA-C22.2 No.61010-1  
 CAN/CSA-C22.2 No.61010-2-030  
 EN61010-1  
 EN61010-2-030

EMC: EN61326-1 Class A, Table 2 (For use in industrial locations)  
 Influence of immunity environment (Criteria A): Output shift is specified within ± 25% of F.S.

EN61326-2-3

RCM: EN61326-1 Class A, Table 2

Korea Electromagnetic Conformity Standard Class A 한국 전자파적합성 기준

A급 기기 (업무용 방송통신기자재)

이 기기는 업무용(A급) 전자파적합기기로서 판매자 또는 사용자는 이 점을 주의하시기 바라며, 가정외의 지역에서 사용하는 것을 목적으로 합니다.

Russian: TR CU 020/2011

RoHS: EN 50581: 2012 (FLXA202; Style 1.02 or newer, FLXA21; Style 3.03 or newer)

Installation altitude: 2000 m or less

Category based on IEC 61010: I (Note 1)

Pollution degree based on IEC 61010: 2 (Note 2)

Note 1: Installation category, called over-voltage category, specifies impulse withstand voltage.

Equipment with "Category I" (ex. two-wire transmitter) is used for connection to circuits in which measures are taken to limit transient over-voltages to an appropriately low level.

Note 2: Pollution degree indicates the degree of existence of solid, liquid, gas or other inclusions which may reduce dielectric strength. Degree 2 is the normal indoor environment.

● Explosion Protected Type Compliance

Item	Description	'Type' in MS code
Europe (ATEX)	FLXA202 and FLXA21: [Intrinsic safety "ia"] Applicable Standard: EN 60079-0: 2012 + A11: 2013, EN 60079-11: 2012 Certificate No: DEKRA 11ATEX0109X Marking/Rating:  II 1 G Ex ia IIC T4 Ga Ambient Temperature: -20 to 55°C Control Drawing: Refer to App. 5.1	-CB
International (IECEx)	FLXA202 and FLXA21: [Intrinsic safety "ia"] Applicable Standard: IEC 60079-0: 2011, IEC 60079-11: 2011 Certificate No: IECEx DEK 11.0044X Marking/Rating: Ex ia IIC T4 Ga Ambient Temperature: -20 to 55°C Control Drawing: Refer to App. 5.1	
United States (FM)	FLXA202 and FLXA21: [Intrinsically safe / Nonincendive] Applicable Standard: Class 3600: 2011, Class 3610: 2010, Class 3611: 2004, Class 3810:2005, NEMA 250: 2014, ANSI/ISA 60079-0: 2013, ANSI/ISA 60079-11: 2014 Certificate No: 3039632 Marking/Rating: IS CL I, DIV 1, GP ABCD CL I, ZN 0, AEx ia IIC NI CL I, DIV 2, GP ABCD CL I, ZN 2 IIC T4: for ambient temperature: -20 to 55°C Enclosure: Type 4X Control Drawing: Refer to App. 5.3	-CD
Canada (CSA)	FLXA202 and FLXA21: [Intrinsically safe / Nonincendive] Applicable Standard: C22.2 No.0-10 (R2015), CAN/CSA-C22.2 No.94-M91 (R2011), C22.2 No.213-M1987 (R2013), CAN/CSA-C22.2 No.60079-0:11, CAN/CSA-C22.2 No.60079-11:14, CAN/CSA-C22.2 No.61010-1-12, CAN/CSA-C22.2 No.61010-2-030-12 Certificate No: 2425510 Marking/Rating: Ex ia IIC T4 Ga Intrinsically safe for Class I, Division 1, Groups A, B, C, D, T4 Nonincendive for Class I, Division 2, Groups A, B, C, D, T4 Ambient Temperature: -20 to 55°C Ambient Humidity: 0 – 100% (No Condensation) Enclosure: IP66, NEMA 4X Control Drawing: Refer to App. 5.2	
United States (FM)	FLXA202 and FLXA21: [Nonincendive] Applicable Standard: Class 3600: 2011, Class 3611: 2004, Class 3810: 2005, NEMA 250: 2014 Certificate No: 3039632 Marking/Rating: NI CL I, DIV 2, GP ABCD ZN 2 IIC T4: for ambient temperature: -20 to 55°C Control Drawing: Refer to App. 5.3	-DD
Canada (CSA)	FLXA202 and FLXA21: [Nonincendive] Applicable Standard: C22.2 No.0-10 (R2015), CAN/CSA-C22.2 No.94-M91 (R2011), C22.2 No.213-M1987 (R2013), CAN/CSA-C22.2 No.61010-1-12, CAN/CSA-C22.2 No.61010-2-030-12 Certificate No: 2425510 Marking/Rating: Nonincendive for Class I, Division 2, Groups A, B, C, D, T4 Ambient Temperature: -20 to 55°C Ambient Humidity: 0 – 100% (No Condensation) Enclosure: IP66, NEMA 4X Control Drawing: Refer to App. 5.2	

Item	Description	'Type' in MS code
Canada (CSA)	<p>FLXA202: Applicable Standard: [Type of protection 'n' / Nonincendive] C22.2 No.0-10 (R2015), CAN/CSA-C22.2 No.94-M91 (R2011), C22.2 No.213-M1987 (R2013), CAN/CSA-C22.2 No.60079-0:11, CAN/CSA-C22.2 No.60079-11:14, CAN/CSA-C22.2 No.60079-15:12, CAN/CSA-C22.2 No.61010-1-12, CAN/CSA-C22.2 No.61010-2-030-12</p> <p>Certificate No: 2425510 Marking/Rating: Ex nA ic IIC T4 Gc Nonincendive for Class I, Division 2, Groups A, B, C, D, T4</p> <p>Ambient Temperature: -20 to 55°C Ambient Humidity: 0 – 100% (No Condensation) Enclosure: IP66, NEMA 4X Control Drawing: Refer to App. 5.2</p>	-DE
Europe (ATEX)	<p>FLXA202: Certificate: [Type of protection 'n'] Not Applicable as per Annex VIII to ATEX 2014/34/EU Applicable Standard: EN 60079-0: 2012 + A11:2013, EN 60079-11: 2012, EN 60079-15: 2010, EN 60529: 1991+A2:2013</p> <p>Marking/Rating: <math>\text{Ex}</math> II 3 G Ex nA ic IIC T4 Gc Ambient Temperature: -20 to 55°C Enclosure: IP66 Control Drawing: Refer to App. 5.4</p>	-DB
International (IECEx)	<p>FLXA202: Applicable Standard: [Type of protection 'n'] IEC 60079-0: 2011, IEC 60079-11:2011, IEC 60079-15: 2010 Certificate No: IECEx DEK 16.0034X Marking/Rating: Ex nA ic IIC T4 Gc Ambient Temperature: -20 to 55°C Enclosure: IP66 Control Drawing: Refer to App. 5.5</p>	
China (NEPSI)	<p>FLXA202 and FLXA21: Applicable Standard: [Intrinsic safety "ia"] GB3836.1-2010, GB3836.4-2010, GB 3836.20-2010 Certificate No: GYJ18.1051X Marking/Rating: Ex ia IIC T4 Ga Ambient Temperature: -20 to 55°C Control Drawing: Refer to App. 5.6</p>	-CH
Korea (KOSHA)	<p>FLXA202: Applicable Standard: [Intrinsic safety "ia" ] Notice of Ministry of Labor No. 2016-54 Certificate No: 15-AV4BO-0160X Marking/Rating: Ex ia IIC T4 Ga Ambient Temperature: -20 to 55°C Control Drawing: Refer to App. 5.6</p>	-CG
	<p>FLXA21: Applicable Standard: [Intrinsic safety "ia"] Notice of Ministry of Labor No. 2016-54 Certificate No: 15-AV4BO-0160X Marking/Rating: Ex ia IIC T4 Ambient Temperature: -20 to 55°C Control Drawing: Refer to App. 5.6</p>	-EG

1

PH

SC

ISC

DO

SENCOM

**WARNING****Installation and wiring**

The FLXA202/FLXA21 should only be used with equipment that meets the relevant IEC, American or Canadian standards. Yokogawa accepts no responsibility for the misuse of this unit.

**WARNING**

Don't install "general purpose type" instruments in the hazardous area.

**CAUTION**

The Instrument is packed carefully with shock absorbing materials, nevertheless, the instrument may be damaged or broken if subjected to strong shock, such as if the instrument is dropped. Handle with care.

**CAUTION**

This instrument is a Class A product, and it is designed for use in the industrial environment. Please use this instrument in the industrial environment only.

**CAUTION**

When you open the front panel, make sure the screws are completely out of the screw holes, and then open the front panel slowly in order not to damage the threaded parts on the housing. If the threaded parts are damaged and the screws cannot be tightened, the waterproof performance will deteriorate.

**CAUTION**

The HART communication may be influenced by strong electromagnetic field. In this case another trial of the HART communication and/or operation with FLXA202/FLXA21 touch screen can be carried out.



## WARNING

- Do not use an abrasive or organic solvent in cleaning the instrument.
- Substitution of components may impair suitability for Division 2.  
Do not remove or replace while circuit is live unless area is known to be non hazardous.  
Explosion Hazard – Do not disconnect equipment unless area is known to be non hazardous.  
Do not reset circuit breaker unless power has been removed from the equipment or the area is known to be non hazardous.



## WARNING

### Electrostatic discharge

The FLXA202/FLXA21 contains devices that can be damaged by electrostatic discharge. When servicing this equipment, please observe proper procedures to prevent such damage. Replacement components should be shipped in conductive packaging. Repair work should be done at grounded workstations using grounded soldering irons and wrist straps to avoid electrostatic discharge.

# 1.5 Model & Suffix Codes

● FLXA202

Model	Suffix code	Option code	Description
FLXA202	.....	.....	2-Wire Analyzer
Power supply	-D	.....	Always -D
Housing (Note 12)	-B	.....	Aluminum alloy cast + urethane coating
	-C	.....	Aluminum alloy cast + epoxy coating
	-D	.....	Aluminum alloy cast + high anti-corrosion coating
Display (Note 13)	-D	.....	Anti-glare LCD
Type (Note 1)	-AB	.....	General purpose for CE, RCM
	-AD	.....	General purpose for CSA
	-AG	.....	General purpose for KC
	-AQ	.....	General purpose for EAC with PA
	-AR	.....	General purpose for EAC
	-CB	.....	IS for ATEX, IECEx (Note 14)
	-CD	.....	IS for FM, CSA (Note 2)
	-CF	.....	IS for TIIS (Note 15)
	-CG	.....	IS for KOSHA (Note 3)
	-CH	.....	IS for NEPSI
	-CQ	.....	IS for EAC with PA
	-CR	.....	IS for EAC
	-DB	.....	Type n for ATEX, IECEx
-DD	.....	NI for FM, CSA	
-DE	.....	Type n for CSA	
1st input	-P1	.....	pH/ORP (Note 4)
	-C1	.....	Conductivity (SC)
	-C5	.....	Inductive conductivity (ISC)
	-D1	.....	Dissolved oxygen (DO)
	-S1	.....	pH/ORP (SENCOM sensor) (Note 5)
2nd input (Note 6)	-NN	.....	Without input
	-P1	.....	pH/ORP (Note 4)
	-C1	.....	Conductivity (SC)
	-D1	.....	Dissolved oxygen (DO)
Output	-A	.....	4-20 mA + HART
—	-N	.....	Always -N
Language set (Note 7)	-LA	.....	English and 11 languages
Country (Note 8)	-N	.....	Global except Japan
	-J	.....	Japan
—	-NN	.....	Always -NN
Option	Mounting hardware	/UM	Universal mounting kit (Note 9)
		/U	Pipe and wall mounting hardware
		/PM	Panel mounting hardware
	Hood	/H6	Hood, stainless steel
		/H7	Hood, stainless steel + urethane coating
		/H8	Hood, stainless steel + epoxy coating
	Tag plate	/SCT	Stainless steel tag plate
	Conduit adapter (Note 10)	/CB4	G1/2 x 3 pcs
		/CD4	1/2NPT x 3 pcs
		/CF4	M20 x 1.5 x 3 pcs
		/CB5	G1/2 x 3 pcs for Type n
/CD5		1/2NPT x 3 pcs for Type n	
	/CF5	M20 x 1.5 x 3 pcs for Type n	
Measurement law	/K	With Measurement Law certificate (Note 11)	

Notes:

- 1: Type “-C \*” is intrinsic safety (IS), Type “-DB” is type n of ATEX and IECEx, Type “-DD” is nonincendive (NI) of FM and CSA Type “-DE” is type n of CSA.
- 2: Type “-CD” is intrinsic safety, but is available as nonincendive.
- 3: Korean IM is attached to FLXA202 instead of English IM.
- 4: This input is to be come from an analog pH/ORP sensor.

- 5: When the analyzer is connected with the digital sensor (FU20F pH/ORP SENCOM Sensor)
- 6: When a 2nd input is selected, only the same kind of the 1st input is available.  
For example, when a 1st input is "-P1", the 2nd input must be the same "-P1".  
The combination of ISC and ISC is not available. And, the combination of SENCOM sensor and SENCOM sensor is not available, either.
- 7: These languages are message languages on the analyzer's display.  
One analyzer has English and 11 languages.  
All languages are as follows; English, Chinese, Czech, French, German, Italian, Japanese, Korean, Polish, Portuguese, Russian and Spanish.
- 8: When an analyzer is used in Japan, it must meet the Japanese Measurement Law, please select the "-J".  
Only SI units must be used on the analyzer and its documents in Japan.
- 9: The universal mounting kit contains the pipe and wall mounting hardware (/U) and the panel mounting hardware (/PM).
- 10: "/CB5", "/CD5", "/CF5" can use "type n" model (-DB, -DE), other model can use "/CB4", "/CD4", "/CF4".
- 11: The analyzer with Japanese Measurement Law certificate is available only for the following model;  
FLXA202-D-[Housing code]-D-AB-P1-NN-A-N-LA-J-NN/[option code except /K]/K  
Only one pH measurement with an analog sensor is certified. The digital sensor (FU20F) is not certified.  
The output signal of 4 - 20 mA is certified. HART communication is not certified
- 12: Urethane coating is for acid resistance, and epoxy coating is for alkali resistance. For high anti-corrosion coating, both urethane coating and epoxy coating are applied.
- 13: Type "-CF" is anti-reflection coated. Other types are anti-glare coated.
- 14: Product registration is done by Yokogawa Taiwan Corporation as an importer in Taiwan.
- 15: For detailed information refer to Japanese GS 12A01A03-01JA.

**PH****SC****ISC****DO****SENCOM**



● FLXA21

Model	Suffix code	Option code	Description
FLXA21	.....	.....	2-Wire Analyzer
Power supply	-D	.....	Always -D
Housing	-P	.....	Plastic
Display	-D	.....	Anti-glare LCD
Type	-AB -AD -AG -AQ -AR -CB -CD -CH -EG -ER -DD	.....	General purpose for CE, RCM General purpose for CSA General purpose for KC General purpose for EAC with PA (Note 11) General purpose for EAC (Note 12) IS for ATEX, IEC Ex (Note 9) IS for FM, CSA (Note 5) IS for NEPSI (Note 15) IS for KOSHA (Note 10) IS for EACEx with PA (Note 13) IS for EACEx (Note 14) NI for FM, CSA (Note 16)
1st input	-P1 -C1 -C5 -D1 -S1	.....	pH/ORP (Note 6) Conductivity (SC) Inductive conductivity (ISC) Dissolved oxygen (DO) pH/ORP (SENCOM sensor) (Note 7)
2nd input (Note 1)	-NN -P1 -C1 -D1	.....	Without input pH/ORP (Note 6) Conductivity (SC) Dissolved oxygen (DO)
Output (Note 8)	-A	.....	4-20 mA + HART
—	-N	.....	Always -N
Language set (Note 2)	-LA	.....	English and 11 languages
Country (Note 3)	-N -J	.....	Global except Japan Japan
—	-NN	.....	Always -NN
Option	Mounting hardware  Hood  Tag plate Conduit adapter	/UM /U /PM /H6 /H7 /H8 /SCT /CB4 /CD4 /CF4	Universal mounting kit (Note 4) Pipe and wall mounting hardware Panel mounting hardware Hood, stainless steel Hood, stainless steel + urethane coating Hood, stainless steel + epoxy coating Stainless steel tag plate Conduit adapter (G1/2 x 4 pcs) Conduit adapter (1/2NPT x 4 pcs) Conduit adapter (M20 x 1.5 x 4 pcs)

Notes:

- 1: When a 2nd input is selected, only the same kind of the 1st input is available.  
For example, when a 1st input is “-P1”, the 2nd input must be the same “-P1”.  
The combination of ISC and ISC is not available. And, the combination of SENCOM sensor and SENCOM sensor is not available, either.
- 2: These languages are message languages on the analyzer’s display.  
One analyzer has English and 11 languages.  
All languages are as follows; English, Chinese, Czech, French, German, Italian, Japanese, Korean, Polish, Portuguese, Russian and Spanish.
- 3: When an analyzer is used in Japan, it must meet the Japanese Measurement Law.  
Only SI units must be used on the analyzer and its documents in Japan.
- 4: The universal mounting kit contains the pipe and wall mounting hardware (/U) and the panel mounting hardware (/PM).
- 5: The type “-CD” is intrinsic safety of FM and CSA, and non-incendive of FM and CSA. Temperature classes are T4.
- 6: This input is to be come from an analog pH/ORP sensor.
- 7: When the analyzer is connected with the digital sensor, FU20F pH/ORP SENCOM Sensor, only the following model is available;  
2nd input: Without input (-NN)
- 8: The FLXA21 has other output types of “FOUNDATION Fieldbus” communication (suffix code: -F) and “PROFIBUS PA” communication (suffix code: -P). Refer to IM 12A01A02-71E and IM 12A01A02-72E.
- 9: The type “-CB” intrinsic safety type of ATEX and IECEx can be used with SENCOM sensor. Temperature class is T4.  
Product registration is done by Yokogawa Taiwan Corporation as an importer in Taiwan.
- 10: The type “-EG” intrinsic safety type of KOSHA for Korea. Temperature class is T4.

- 11: The type “-AQ” is General purpose type of EAC with Pattern Approval for Russia.
- 12: The type “-AR” is General purpose type of EAC for Kazakhstan and Belarus.
- 13: The type “-EQ” intrinsic safety type of EAC with Pattern Approval for Russia. Temperature class is T4.
- 14: The type “-ER” intrinsic safety type of EAC for Kazakhstan and Belarus. Temperature class is T4.
- 15: The type “-CH” intrinsic safety type for NEPSI. Temperature class is T4.
- 16: The type “-DD” nonincendive type for FM. Temperature class is T4.

PH

SC

ISC

DO

SENCOM



# 2. WIRING AND INSTALLATION

Install the cable glands into the FLXA202/FLXA21 before installing it (see section 2.3.) Upon delivery, the cable glands are not installed.

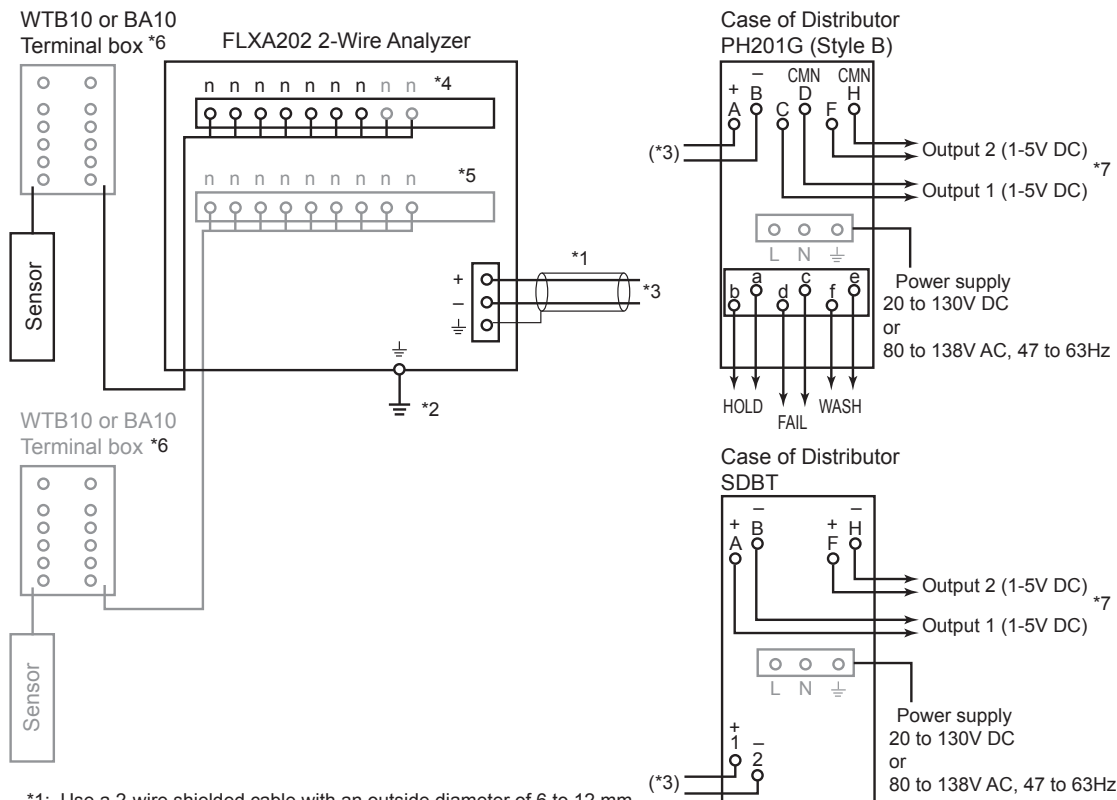

- \*1: Use a 2-wire shielded cable with an outside diameter of 6 to 12 mm.
- \*2: Connect the analyzer to ground. (Class D ground: 100 ohm or less)
- \*3: This line is connected to a distributor or 24V DC power supply.
- \*4: Terminal numbers for each sensor module are shown below.
- \*5: Two modules of the same kind of measurement/sensor type can be installed. When measuring inductive conductivity or pH/ORP with the SENCOM sensor, only one module can be installed.
- \*6: The terminal box may be necessary depending on the sensor cable length and the distance between the analyzer and the sensor.  
The SENCOM sensor is to be connected directly to the analyzer without a terminal box.
- \*7: Two outputs, output 1 and output2, of PH201G or SDBT are same signals.

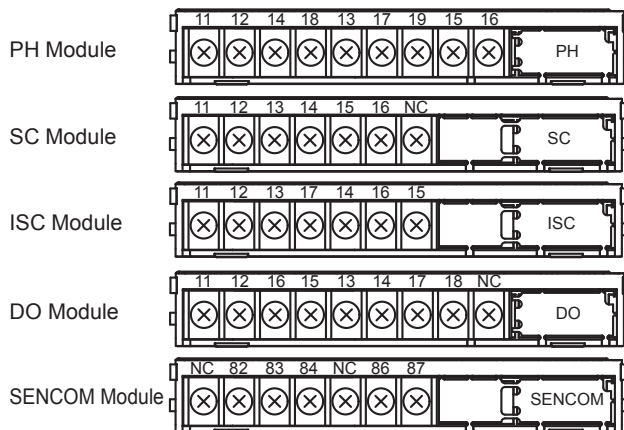
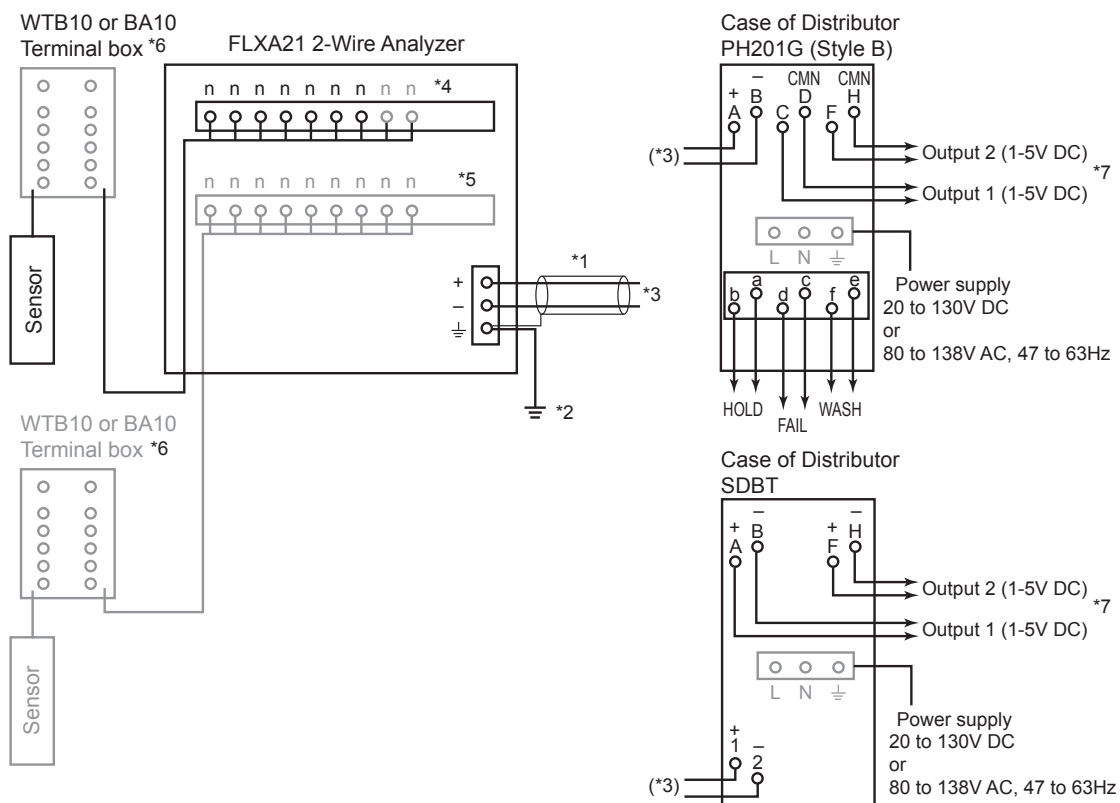

Figure 2.1 FLXA202 Wiring diagrams



- \*1: Use a 2-wire shielded cable with an outside diameter of 6 to 12 mm.
- \*2: Connect the analyzer to ground. (Class D ground: 100 ohm or less)  
Connect the grounding cable to the ⊥ terminal of the power module inside.  
Use a cable with an outside diameter of 3.4 to 7 mm for the grounding line.
- \*3: This line is connected to a distributor or 24V DC power supply.
- \*4: Terminal numbers for each sensor module are shown below.
- \*5: Two modules of the same kind of measurement/sensor type can be installed. When measuring inductive conductivity or pH/ORP with the SENCOM sensor, only one module can be installed.
- \*6: The terminal box may be necessary depending on the sensor cable length and the distance between the analyzer and the sensor.  
The SENCOM sensor is to be connected directly to the analyzer without a terminal box.
- \*7: Two outputs, output 1 and output2, of PH201G or SDBT are same signals.

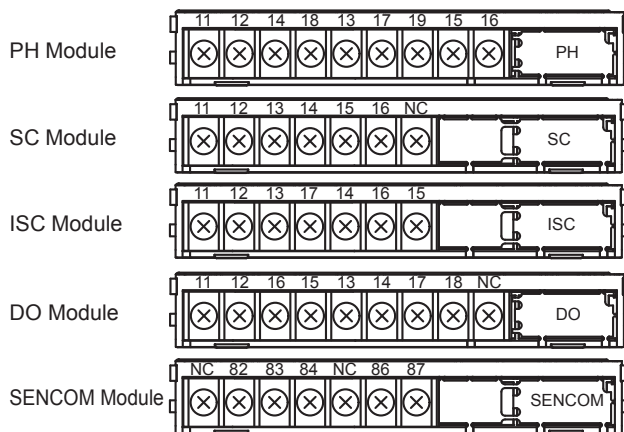

Figure 2.2 FLXA21 Wiring diagrams

## 2.1 Installation site

The FLXA202/FLXA21 is weatherproof and can be installed both inside and outside. It should, however, be installed as close as possible to the sensor to avoid long cable runs between the instrument and sensor. When the pH sensor is used, the cable length including the sensor cable should not exceed 20 meters (65.6 feet); 60 meters (197 feet) when using BA10 extension box and WF10 cable.

For a conductivity sensor the cable run should not exceed 60 meters (197 feet). For dissolved oxygen the sensor cable run should not exceed 30 meters (100 feet). For SENCOM pH/ORP the sensor cable run should not exceed 20 meters (65.6 feet).

Select an installation site where the ambient temperature and humidity are within the limits of the instrument specifications (see chapter 2). If the instrument is installed outside and exposed to direct sunlight, a sun shade hood should be used.

Ambient Operating Temperature: -20 to +55 °C

Storage Temperature: -30 to +70 °C

Humidity: 10 to 90% RH at 40°C (Non-condensing)

Select an installation site that meets the following conditions.

- Mechanical vibrations and shocks are negligible
- No relay switch and power switch are installed close to the converter
- There is space for cable connection beneath the cable glands
- Not exposed to direct sunlight or severe weather conditions
- Maintenance is possible
- No corrosive atmosphere
- Water Protection: IP66, NEMA Type 4X (USA), Type 4X(Canada)

## 2.2 Removing the wiring cover

Before installing this instrument, open the front panel and remove the wiring covers, and then install the cable glands.

### NOTE

Wiring covers are required intrinsic safety and Type n (Type is -C\*, -DB, -DE). In the case of other types, the cover is not attached to the FLXA202.

#### ● FLXA202

Remove wiring covers 1 and 2 by raising the circled area in Figure 2.3.

### NOTE

Wiring covers are required intrinsic safety (Type is -C\*).

In the case of other types, the cover is not attached to the FLXA202.

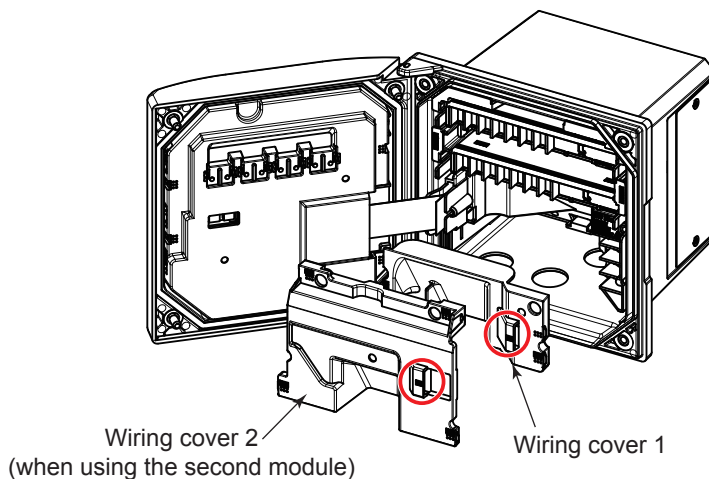

Figure 2.3 FLXA202 Wiring cover

#### ● FLXA21

Remove all the wiring covers. They are fixed at the places marked with ○ (circle) and △ (triangle) in Figure 2.4. Be careful not to damage the pawls when removing the covers.

### NOTE

Be careful not to lose the wiring cover screws.

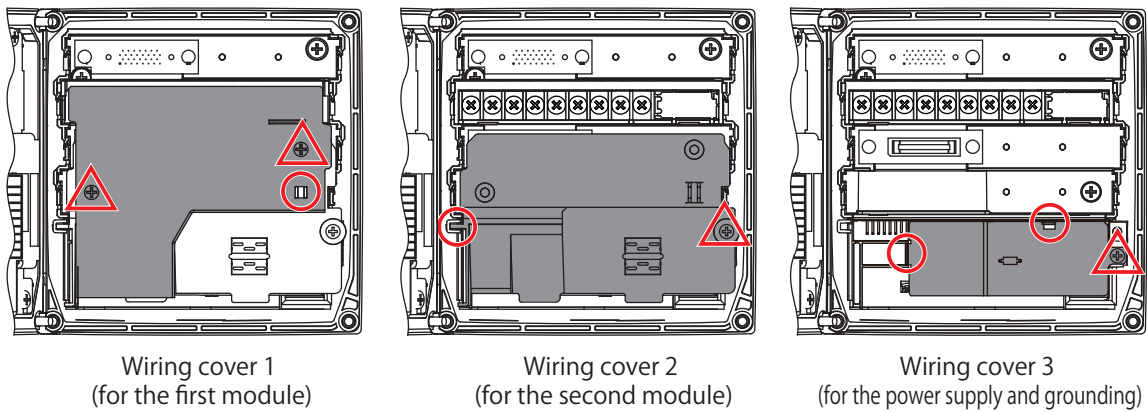

Figure 2.4 FLXA21 Wiring cover

## 2.3 Installing the cable glands

### WARNING

For Type n model (-DB, -DE),

- When the accompanying cable glands are used, external clamping is required additionally.
- When the optional conduit adaptors(/CB5, /CD5, /CF5) are used with accompanying cable glands, clamping; e.g) sealing fitting is required.
- If external clamping is not able to be prepared, Ex d, Ex e, or Ex n cable gland which provides sufficient clamping shall be used instead of the accompanying cable gland.
- Unused cable gland shall be sealed with the accompanying metal plug.

The supplied cable glands are for cables with an outside diameter of 6 to 12 mm (0.24 to 0.47 inches). Unused cable entry holes must be sealed with cable glands including the supplied close up plugs.

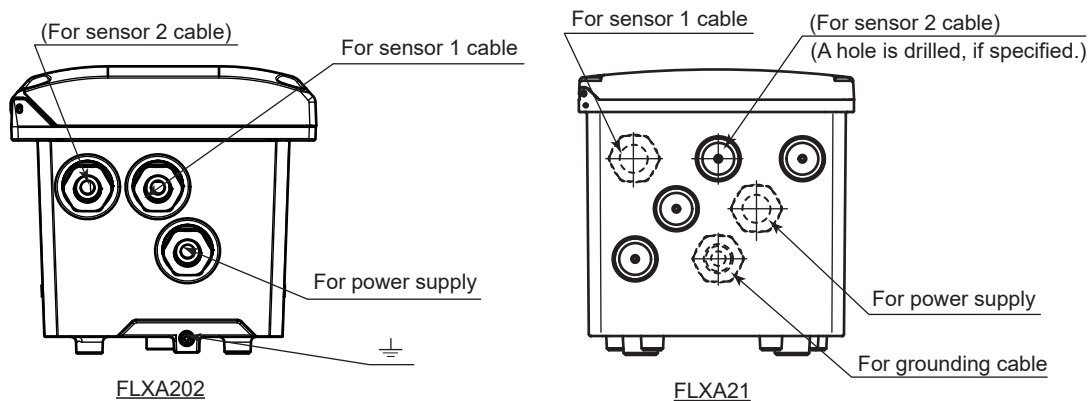

Figure 2.5 Cable gland diagram

### CAUTION

Be careful not to be injured by the sharp hole edges on the housing.

Install the supplied cable gland as shown in Figure 2.6. When using an adapter for conduit work, see Figure 2.7.

- PH
- SC
- ISC
- DO
- SENCOM



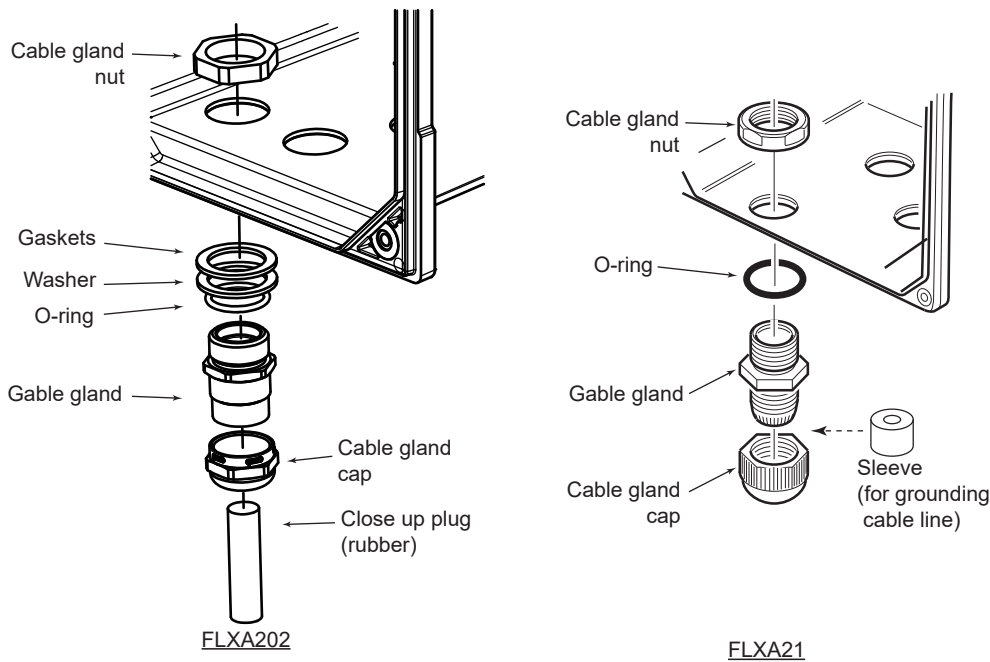

**Figure 2.6** Cable glands

The unused cable glands should be sealed with the supplied close up plug.

**CAUTION**

When installing cable glands, hold cable glands and tighten cable gland nuts to a torque of 6 N•m. If cable glands, not gland nuts, are tightened, O-rings may come out from the proper positions.

● **Adapter for conduit work**

When protecting the cable with a conduit, use an adapter (option codes: /CB4, /CD4, or /CF4). Set the adapter as shown in figure 2.7, instead of using the cable gland as shown in figure 2.6.

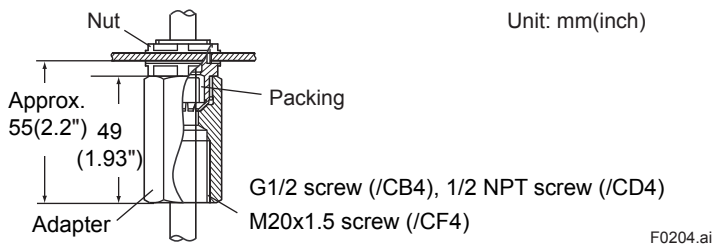

**Figure 2.7** Adapter for conduit work (option)

**CAUTION**

When using a cable conduit, use a flexible conduit to avoid stress on the conduit adapter. The stress on the conduit adapter may damage the housing.

## 2.4 Wiring the power supply

First make sure that the power supply is in accordance with the given specifications.

Power Supply: Nominal 24 V DC loop powered system

The load resistance: impedance of electronic equipment: typically 250 Ohm.

Number of input modules: 1-sensor measurement or 2-sensor measurement.

One (1) Sensor module (1 input): 16 to 40V DC (for pH/ORP, SC and DO),  
17 to 40V DC (for ISC), 21 to 40V DC (for SENCOM)

Two (2) Sensor modules (2 inputs): 22.8 to 40V DC (for pH/ORP, SC and DO)

Note: When the FLXA202/FLXA21 is used in the multi-drop mode of HART communication, the output signal is changed from 12.5 mA DC to 4 mA DC just after the power is turned on. Enough power supply for the instruments is to be provided.

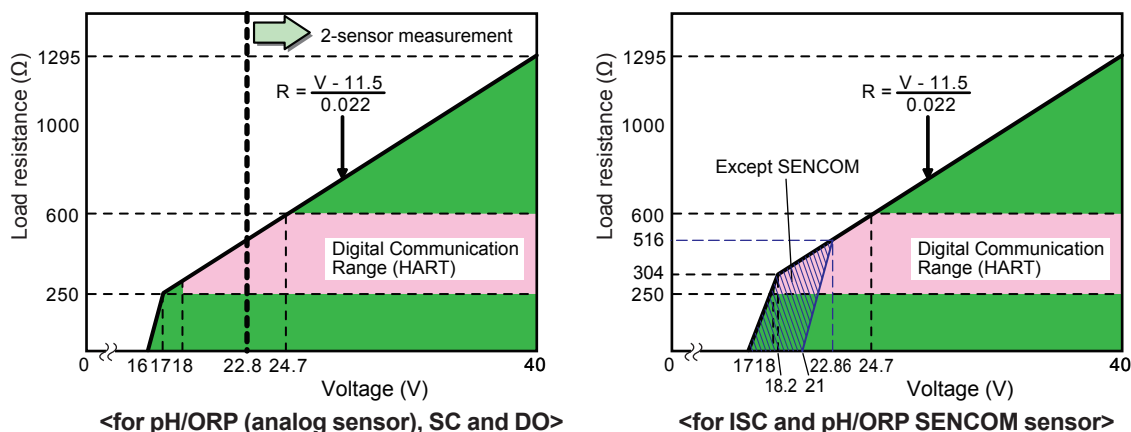

Figure 2.8 Supply Voltage and Load Resistance

Open the front panel and remove the wiring covers to make the terminal block accessible.

### CAUTION

The FLXA202/FLXA21 is used with a DC power supply. Do not use an alternating current or 100 volt mains power supply.

The cable leading to the distributor (power supply) supplies the power to and transmits the output signal from the FLXA202/FLXA21.

Use a two conductor shielded cable with a minimum cross sectional area of 1.25 mm<sup>2</sup> and an outside diameter of 6 to 12 mm. The cable gland supplied with the instrument is compatible with these diameters.

Terminal screw size is M4, and torque of screw up is 1.2 N•m.

Pin terminal, ring terminal and spade terminal can be used for the power supply terminals and the grounding terminal.

Pin terminal: pin diameter: max. 1.9 mm

Ring and spade terminal: width: max. 7.8 mm

### CAUTION

Cables that withstand temperatures of at least 60°C should be used for wiring.

- PH
- SC
- ISC
- DO
- SENCOM

## CAUTION

Always place the shield cover over the power supply and contact terminals for safety reasons and to avoid interference.

### 2.4.1 Grounding

The method to connect the grounding terminal is different for the FLXA202 and FLXA21.

For the safety of the user and to protect the instrument against interference, the converter housing must always be connected to a class D ground (a ground resistance of 100 ohm or less).

#### ● Grounding the FLXA202 housing

Use the  $\perp$  terminal outside the converter housing for grounding (Figure 2.9A).

Use a ring terminal.

When connecting the converter to a distributor, connect the shield of a double-core shielded cable to the  $\perp$  terminal on the terminal block in the converter. Do not connect the shield to the ground terminal in the distributor.

#### ● Grounding the FLXA21 housing

Connect a single separate cable for grounding to the terminal block in the housing (Figure 2.9B).

Use a cable with an outer diameter of 3.4 to 7 mm.

Since the cable is very thin, set the sleeve inside the standard cap of the cable gland and pass the cable through it. Sleeves are supplied with cable glands (Figure 2.6).

When connecting the converter to a distributor, connect the shield of a double-core shielded cable to the  $\perp$  terminal on the terminal block in the converter. Do not connect the shield to the ground terminal in the distributor.

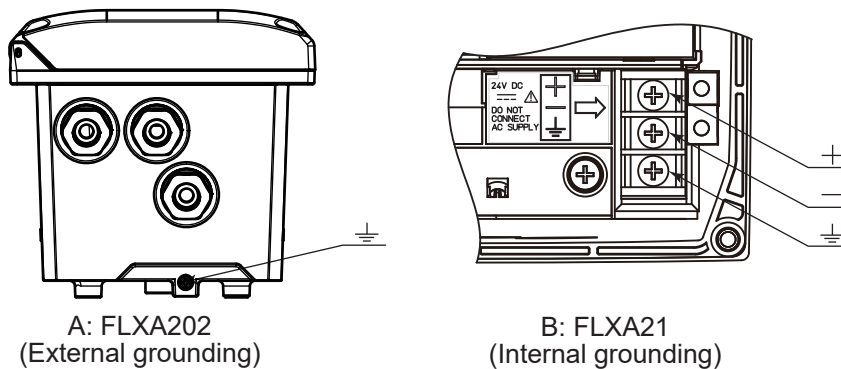

Figure 2.9 Grounding

### 2.4.2 Connection of the power supply

Pass the supply/output cable through the power cable hole shown in Figure 2.5 into the converter and connect it to the terminals marked +, - and  $\perp$  according to the marks on the power terminal (Figure 2.10).

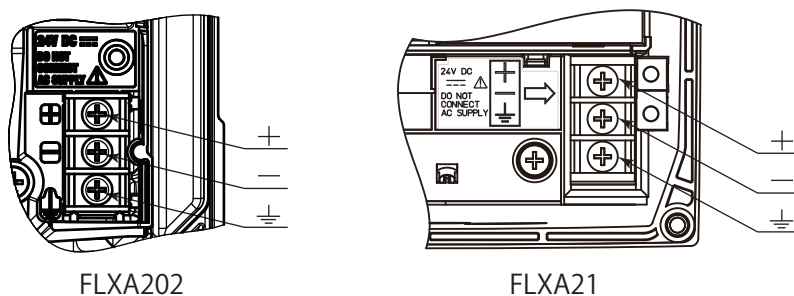

Figure 2.10 Power terminal

### 2.4.3 Wiring cover

#### NOTE

Wiring covers are required intrinsic safety and Type n (Type is -C\*, -DB, -DE). In the case of other types, the cover is not attached to the FLXA202.

#### ● FLXA202

When grounding and power supply wiring are complete, double-check the wiring and the like, and attach wiring cover 1 (Figure 2.11).

When attaching the wiring cover, align the protruding parts marked with squares in the figure to the grooves.

If only the first module is to be used, wire the detector to the first module.

If the second module is to be used, wire the detector to the second module and attach wiring cover 2 before wiring the first module.

Then, wire the detector to the first module.

Detector wiring is indicated in section 2.5.

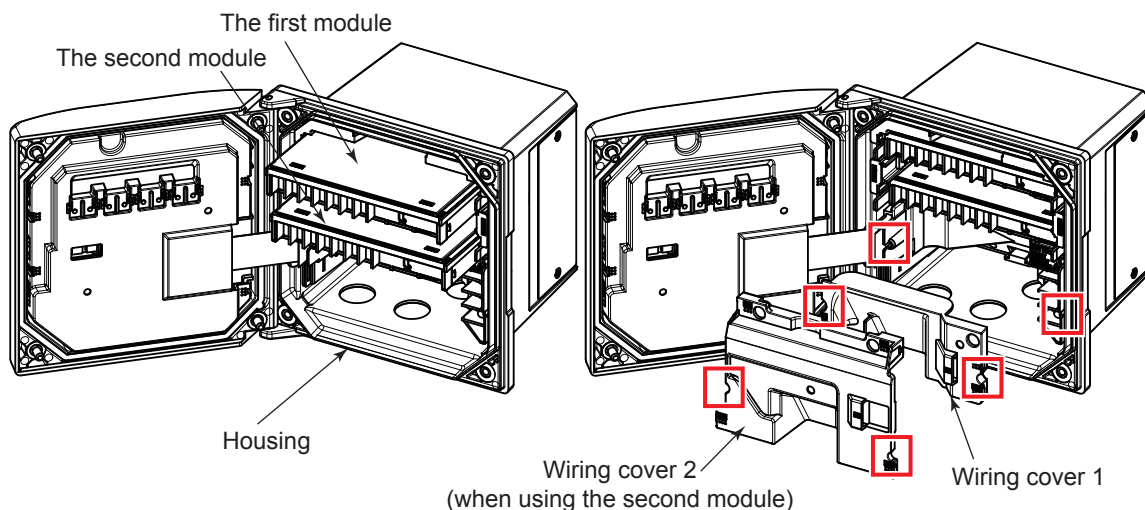

Figure 2.11 FLXA202 Wiring cover

#### NOTE

Wiring covers are required intrinsic safety (Type is -C\*).

In the case of other types, the cover is not attached to the FLXA202.

- PH
- SC
- ISC
- DO
- SENCOM

- **FLXA21**

After grounding and connecting the power supply, check the wiring and then close the wiring cover 3 (Figure 2.4).

When closing the cover, engage the positions marked with ○ in Figure 2.4 and fasten the cover with the screw at the position marked with Δ.

### **CAUTION**

---

The screw in the area marked with Δ should be tightened to a torque of 0.35 to 0.45 N•m.

---

If a second module is used, wire the sensor for the second module and attach the wiring cover (refer to figure 2.12).

Then, wire the sensor for the first module and attach the wiring cover (refer to figure 2.11).

The sensor wiring is shown in section 2.4.

### **NOTE**

---

Be careful not to lose the wiring cover screws.

---

## 2.5 Sensor wiring

The FLXA202/FLXA21 can be used with a wide range of commercially available sensor types, both from Yokogawa and other manufacturers.

Terminal screw size is M4, and torque of screw up is 1.2 N•m.

Pin terminal, ring terminal and spade terminal can be used.

Pin terminal: pin diameter: max. 1.9 mm

Ring and spade terminal: width: max. 7.8 mm

For details on the sensors, refer to the respective instruction manuals of the sensors.

### **NOTE**

---

When input 2 is used, the upper-level module is for input 1. Be careful not to make a mistake when wiring the modules.

---

- **FLXA202**

When wiring covers are available:

Attach wiring cover 1. If the second input is available, wire the second module in the lower level, and attach wiring cover 2.

Finally, wire the first module.

If the second input is not available, attach wiring cover 1, and then wire the first input.

Note that if the second input is not available, wiring cover 2 is not included.

When wiring covers are not available:

If the second input is available, wire the second module in the lower level first.

Then, wire the first module.

If the second input is not available, wire only the first input.

**NOTE**

Wiring covers are required intrinsic safety (Type is -C\*).  
In the case of other types, the cover is not attached to the FLXA202.

When all the detector wiring is complete, close the FLXA202 front cover, and turn the power on. Check that the screen displays normally.

**CAUTION**

Do not tighten up four front panel screws one by one.  
Each front panel screw should be tightened up in two times of screwing. And, firstly the screw at the upper left should be screwed a bit, the next is at the lower right, third is at the upper right, and fourth is at the lower left. The second round is the same sequence again to tighten up four screws.  
Do not use an electric screwdriver with high revolutions. If an electric screwdriver is used for these front panel screws, the revolutions of the electric screwdriver should be less than 400 rpm.  
Four screws should be tightened to the following torque; 0.8 to 0.9 N•m

● **FLXA21**

When input 2 is used, first wire input 2 which is on the lower second module, and attach the wiring cover.  
Even when input 2 is not used, first attach the power supply/grounding wiring cover and then the wiring cover for the second module, and finally wire input 1.

**NOTE**

When the wiring of sensors is finished, be sure to attach the wiring covers. Furthermore, make sure the module is locked with the mechanisms on the left and right of the module.

**CAUTION**

Confirm that all locking-tabs (including for BLANK slots) are in "Lock" position before you close the front panel. If the locking-tabs are in "Unlock" position, the front panel may be interfered with locking-tabs.

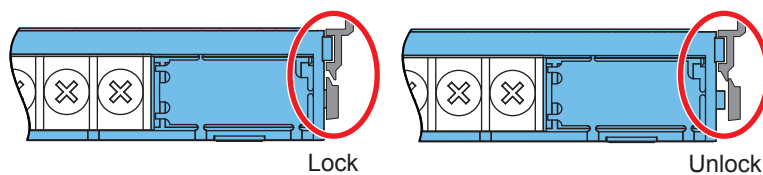

**Figure 2.12** Locking the module

When all sensor wiring is completed, close the front panel of the FLXA21, and turn on the power. Make sure that the display is normal.

PH

SC

ISC

DO

SENCOM

## CAUTION

Do not tighten up four front panel screws one by one.

Each front panel screw should be tightened up in two times of screwing. And, firstly the screw at the upper left should be screwed a bit, the next is at the lower right, third is at the upper right, and fourth is at the lower left. The second round is the same sequence again to tighten up four screws.

Do not use an electric screwdriver with high revolutions. If an electric screwdriver is used for these front panel screws, the revolutions of the electric screwdriver should be less than 400 rpm.

Four screws should be tightened to the following torque; 0.8 to 0.9 N·m

## ■ Wiring of YOKOGAWA sensors

Sensor	Measurement	FLXA202/FLXA21 Terminals									Short *2 FLXA202 /FLXA21 Terminals	Remark	
		11	12	13	14	15	16	17	18/13	19/15			
		Sensor cable marking (or color)							Jumper *1				
DO30G	DO	11	12	13	14	15	16						Fixed Cable
FU20/ PH20/ FU24	pH, pH & ORP, rH	11	12	13	14	15	16		Yes	No			Fixed Cable
FU20/ PH20/ FU24	ORP	11	12	13		14			Yes	Yes	13/14		Fixed Cable
FU20/ PH20/ FU24	pH Comp. ORP	11	12	15		14		16	No	Yes	13/14		Fixed Cable
FU20-VP/ FU24-VP	pH, pH & ORP, rH	E	F	B	D	A			Yes	No			VP6-SC
FU20-VP/ FU24-VP	ORP	E	F	B		D			Yes	Yes	13/14		VP6-SC
FU20-VP/ FU24-VP	pH Comp. ORP	E	F	A		D			No	Yes	13/14		VP6-SC
ISC40	ISC	11	12	13	14	15	16						Fixed Cable
PR20/ PR10	pH	11	12	13	14	15	16		Yes	No			Fixed Cable
SC21	pH			Blue	Liquid Earth	Red		(White)	No	No			WU20 Triax
SC24V	pH	E	F	C	H	A	B	D					VP8-DC
SC25V	pH	E	F	B	D	A			Yes	No			VP6-SC
SC29-PTG	pH Comp. ORP			Red	Liquid Earth	Blue		(White)					WU20 Triax
SC29-PTP	ORP			Blue	Liquid Earth	Red		(White)	Yes	Yes			WU20 Triax
SC42	SC	11	12	13	14	15	16						WU40 cable
SC4A	SC	11	12	13	14	15	16						Fixed Cable
SM21/ SR20/ SM60	pH	Green: Red	Green: Blue	Yellow: Red	Black	Red: Red	Red: Blue	Yellow: Blue	Yes	No			WU20 Color Coded Coax
SM29/ SR20	ORP			Yellow: Red	Black	Red: Red	Red: Blue	Yellow: Blue	Yes	Yes			WU20 Color Coded Coax
SX42	SC	Brown	Brown	Yellow: Green		Red					13/14 and 15/16		Sensor Wiring

\*1: The jumper cables to short are attached to the product.

\*2: Jumper cables to short are supplied by users.

Sensor	Measurement	Board Terminals					Remark
		82	83	84	86	87	
FU20F	pH, pH & ORP, rH	82	83	84	86	87	WU11 Cable

■ Wiring of HAMILTON sensors

Sensor	Measurement	FLXA202/FLXA21 Terminals										Short *2 FLXA202 /FLXA21 Terminals	Remark	
		11	12	13	14	15	16	17	18	18/13	19/15			
Sensor cable marking (or color)										Jumper *1				
CHEMTRODE	pH			Blue		Red		(White)			Yes	No	13/14	WU20D Cable
CHEMTRODE- ORP	ORP										Yes	Yes	13/14	
CHEMTRODE- VP	pH	E	F	B		A					Yes	No	13/14	VP6-SC
CLARITRODE	pH			Blue		Red		(White)			Yes	No	13/14	WU20D Cable
CLARITRODE- VP	pH	E	F	B		A					Yes	No		VP6-SC
CONDCUELL	SC	White/ Grey	Blue	Green	Pink	Brown	Yellow							Fixed Cable
CONDCUELL- VP	SC	Blue	Yellow	Black	Black Shield	Grey	Grey Shield							Hamilton VP Cable
EASYFERM	pH			Blue		Red		(White)			Yes	No	13/14	WU20D Cable
EASYFERM- VP	pH	E	F	B		A					Yes	No	13/14	VP6-SC
INCHTRODE	pH	E	F	B	D	A					Yes	No		VP6-SC
MECOTRODE	pH			Blue		Red		(White)			Yes	No	13/14	WU20D Cable
MECOTRODE- VP	pH	E	F	B		A					Yes	No		VP8-DC
OXYFERM- VP/ OXYGOLD	DO	White	Green		Green/ Yellow			Black	Red					Hamilton VP Cable
OXYSENS	DO	Yellow	Blue		Black			Clear	Brown					Fixed Cable
pHEASY	pH	E	F	B	D	A	B				Yes	No		
POLILYTE	pH			Blue		Red		(White)			Yes	No		WU20D Cable
POLILYTE- VP	pH	White	Green	Red	Blue	Black/ Clear					Yes	No		Hamilton VP Cable
POLILYTE PLUS-VP	pH	White	Green	Red	Blue	Black/ Clear					Yes	No		Hamilton VP Cable

\*1: The jumper cables to short are attached to the product.

\*2: Jumper cables to short are supplied by users.

Color coding of Variopin cables

Cable	PIN	A	B	C	D	E	F	G	H
Hamilton	VP6-SC	Black/ Clear	Red	Grey	Blue	White	Green		
Hamilton	VP8-DC	Black/ Clear	Black Shield	Red/ Clear	Red Shield	White	Green	Yellow	Brown
WU20-V-S	VP6-SC	Clear	Brown	Black	Yellow	Red	Blue		
WU20-V-D	VP8-DC	Brown Core	Brown Shield	White Cored	White Shield	Red	Blue	Yellow	

2

PH

SC

ISC

DO

SENCOM



## 2.5.1 Wiring the pH/ORP sensor

### ■ pH Measurement

Conventional pH sensors are connected to the module as follows:

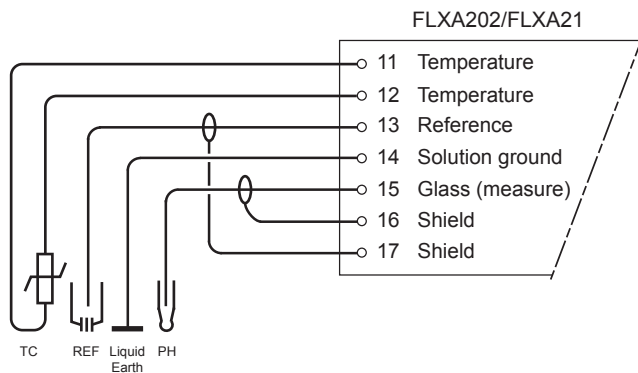

In addition to the wiring of the sensor, insure that a jumper for low-impedance sensor inputs is installed. The jumpers can be found on the plastic sensor module cover and can be stored in the lower level module wiring cover.

- pH Glass Electrode is a high impedance sensor input
- Standard reference electrodes and an ORP/REDOX electrode are low impedance sensor inputs
- Special electrodes using 2 glass sensor (example: Pfaunder, SC24V) do not need jumpers.

Terminals 15-19 are identified as input 1 (High Impedance) and terminals 13-18 are defined as input 2 (Low Impedance). For conventional pH sensors, the jumper is placed as illustrated:

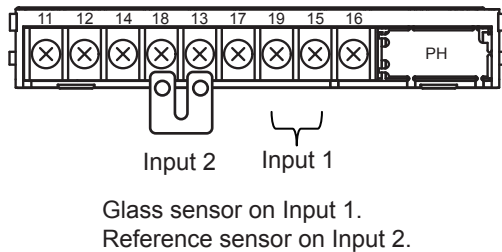

Store jumpers that you do not use in the jumper holder (see Figures 1.1 and 1.2).

## ■ ORP Measurement

The ORP measurement uses the same sensor input module as the pH measurement. It is not uncommon to measure ORP as process variable and a pH Glass electrode as reference. This is the case with rH measurement and with pH compensated ORP measurement.

2

Conventional ORP sensors are connected to the module as follows:

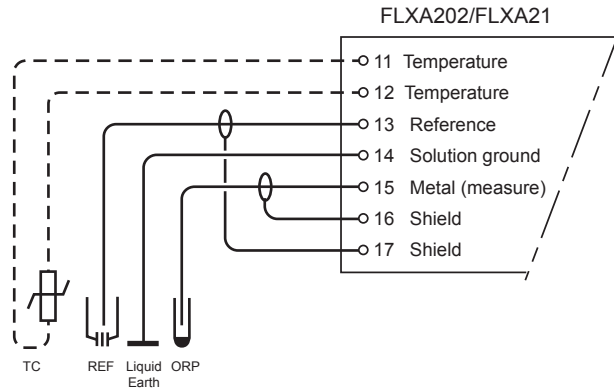

For conventional ORP sensors, the jumpers are placed as illustrated:

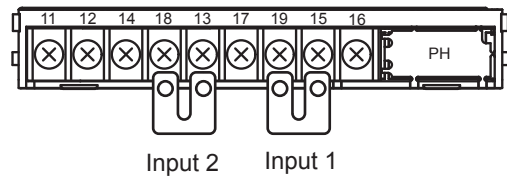

Metal sensor on Input 1.  
Normal reference on Input 2.

pH Compensated ORP sensors are connected to the module as follows:

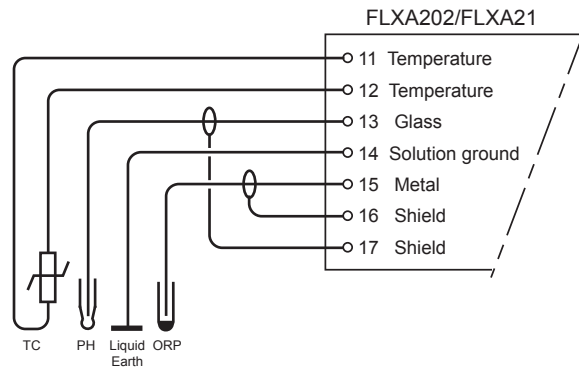

For pH Compensated ORP sensors, the jumper is placed as illustrated:

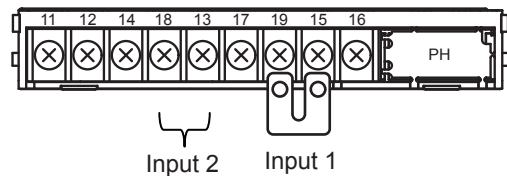

Metal sensor on Input 1.  
pH glass (as reference) on Input 2.

PH  
SC  
ISC  
DO  
SENCOM

**NOTE**

The special grommet is intended to be used to seal the multiple cables from the Yokogawa flow fittings such as FF20.

The designated cables are WU20 sensor cables, which are approximately 5 mm (0.2") in diameter, and K1500FV liquid earth cables, which are approximately 2.5 mm (0.1") in diameter.

For sensor systems using a single cable, like the FU20/FU24 and the PR10, PD20, PF20 and PS20, the standard gland will accommodate the cable adequately. Single cables between approximately 6 mm and 12 mm (0.24" and 0.47") can be sealed properly with these glands and the standard tulle.

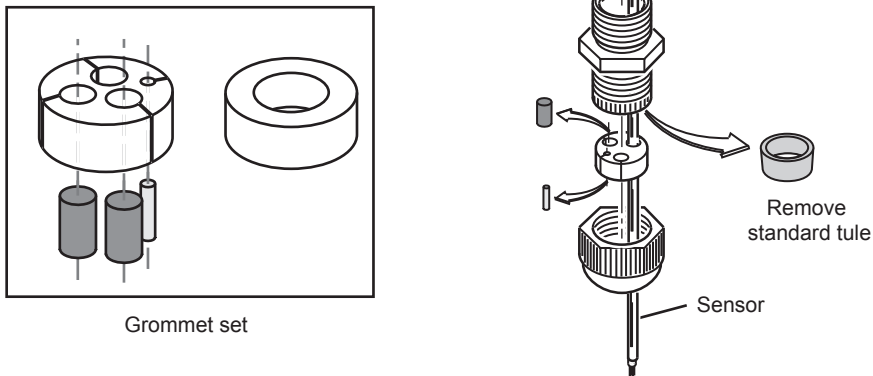
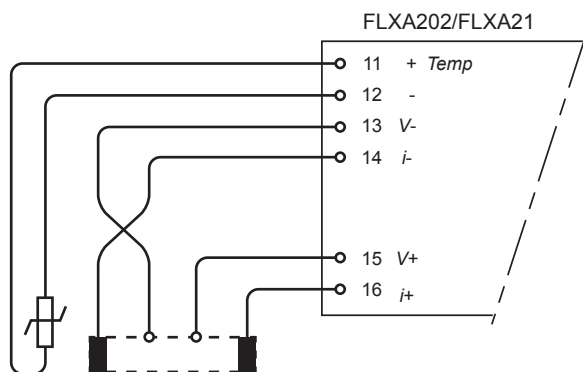

Figure 2.13 Grommet set use

### 2.5.2 Wiring the conductivity (SC) sensor

Contacting Conductivity, SC, sensors are connected to the module as follows:



The above diagram shows wiring for 4-electrode conductivity sensors, such as SC42-SP34 large bore series. For 2-electrode conductivity sensors, such as SC42-SP36 small bore series, jumpers must be installed between terminals 13-14 and between terminals 15-16, as shown in the diagram below.

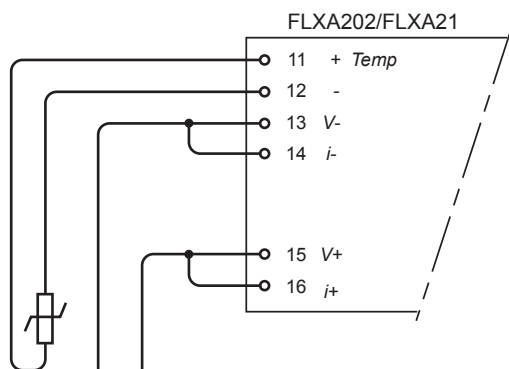

### 2.5.3 Wiring the inductive conductivity (ISC) sensor

ISC40 sensors are connected to the module as follows:

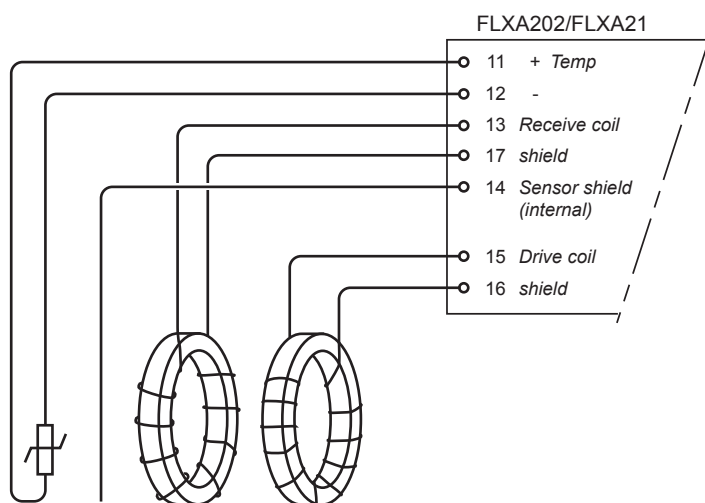

The sensors are supplied with integral cables and each individual wire is marked with the corresponding terminal numbers.

2

PH  
SC  
ISC  
DO  
SENCOM

## 2.5.4 Wiring the dissolved oxygen (DO) sensor

The input module for DO measurement is suitable for different types of DO sensors:

- i. Galvanic sensors like model DO30G
- ii. Polarographic sensors like HAMILTON'S Oxyferm and Oxygold

The connection is as follows:

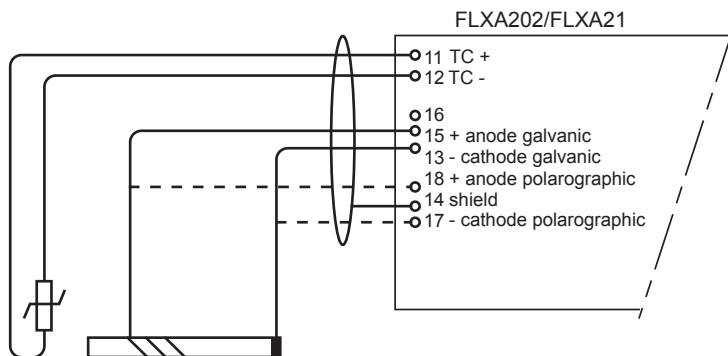

The DO30G sensor comes with integral cable and the wires are labeled with the corresponding terminal numbers.

## 2.5.5 Wiring the SENCOM pH/ORP sensor

FU20F sensors are connected to the module as follows:

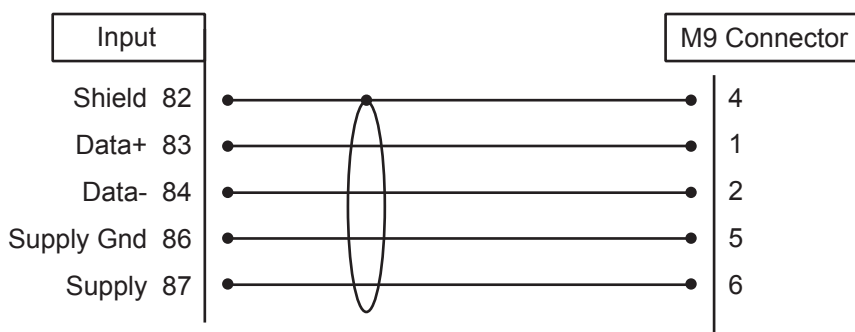

Connect the WU11 SENCOM cable terminal to the SENCOM module.

Since the WU11 cable is thin, attach the included grommet in place of the cable gland standard packing before wiring.

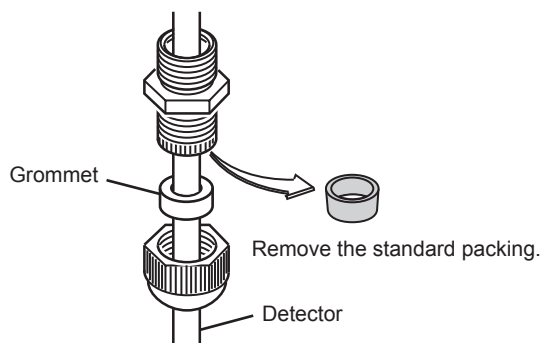

Figure 2.14

## 2.6 Mounting methods

See Figure 2.15. The FLXA202/FLXA21 has various mounting possibilities.

- Panel mounting using optional mounting hardware (/PM or /UM)
- Wall mounting using optional mounting hardware (/U or /UM)
- Pipe mounting using optional mounting hardware (/U or /UM) on a horizontal or vertical pipes (Nominal size: 50A)

The universal mounting kit (/UM) contains the pipe and wall mounting hardware (/U) and the panel mounting hardware (/PM). Some can be left unused.

### Panel mounting

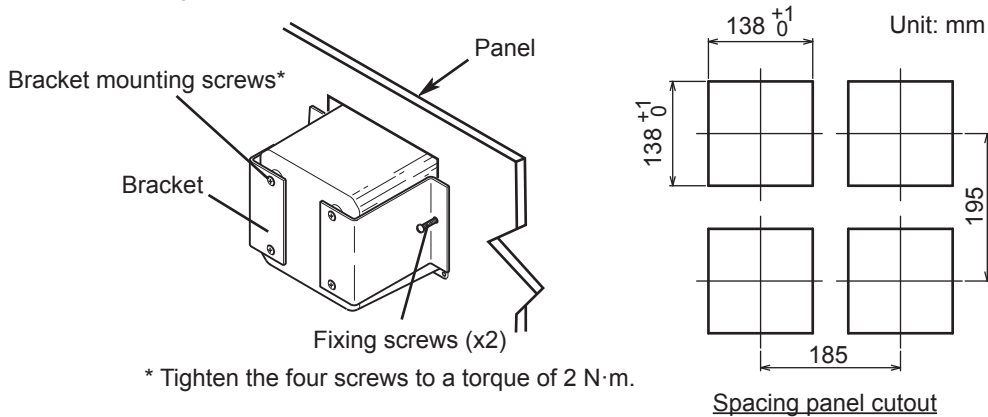

### Wall mounting

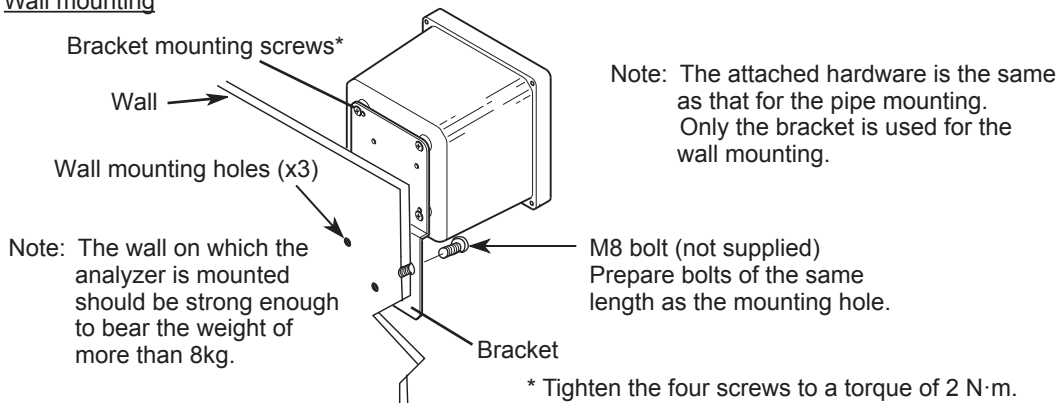

### Pipe mounting

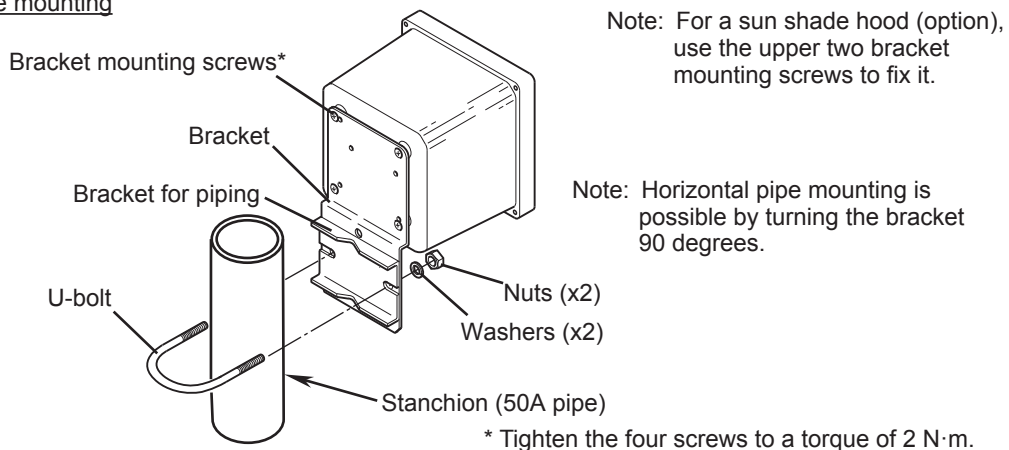

Figure 2.15 Three types of mounting with the optional mounting hardware

See General Specifications (GS 12A01A02-01E) for the dimensions of the FLXA202/FLXA21 and mounting hardware.

## 2.7 Operation

When all wiring is completed, turn on the power of the instrument. Make sure that the LCD screen turns on. Then, the screen changes to the Quick Setup display. If the instrument is not configured, an error indicator may be displayed, or the measurement values displayed may be incorrect. Check the initial settings and change them to suit your purpose.

### NOTE

After turning on the power, it takes occasionally more than 1 minute to change to the Quick Setup display.

### NOTE

A current of 12 mA is output for several seconds after power-on. This is the specification.

Operation from HART is also available.

Setup from HART is also available.

Refer to Technical information (TI 12A01A02-10E) in the CD-ROM.

### CAUTION

When the FLEXA is intrinsic safety type or nonincendive type, DO NOT connect FieldMate™ or HHT (Hand Held Terminal) to the Hazardous side of Associated Apparatus. \*1

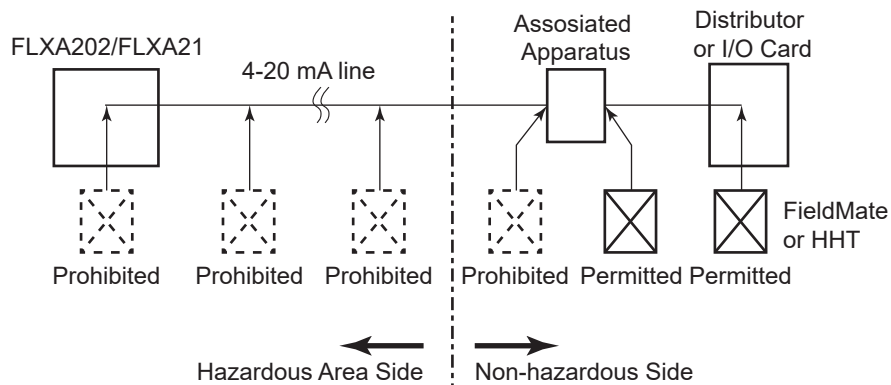

\*1: An Ex-certified HHT may be connected to "Prohibited" points in accordance with the instructions or control drawing of the HHT, if it is confirmed that the connection does not impair the type of protection, from assessment of the related electrical parameters and other conditions.

● **Change language**

When the power is turned on, the Quick setup display appears.

Upon delivery, the display language is set to English. If you want to use a language other than English, select your desired language.

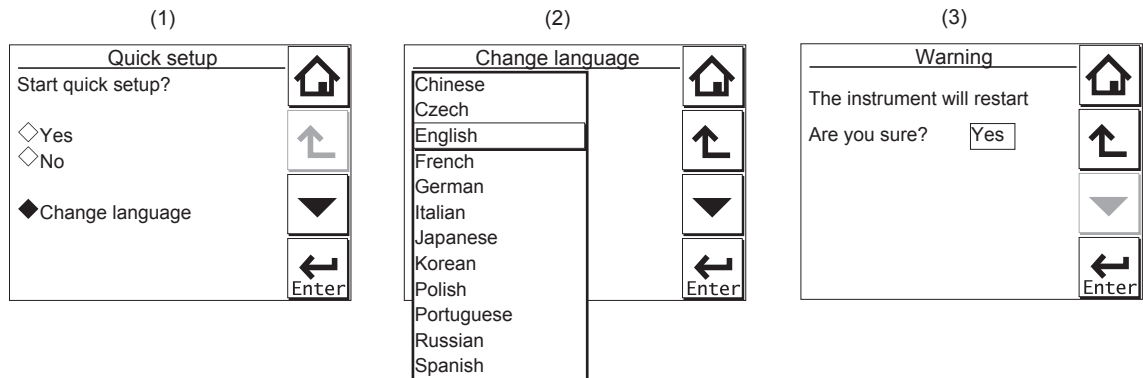

**Figure 2.16** Changing the language

- (1) Select ♦Change language.
- (2) Select a desired language (click the  to scroll the language options.)
- (3) Click YES.

Changing languages automatically reboots the FLXA202/FLXA21.

Check that the parameters match your specifications and modify them if necessary before using the instrument.

A sheet for user settings is contained in the CD-ROM. Please take a memo of your settings on it when you configure the FLXA202/FLXA21 and keep the sheet just in case.





# 3. OPERATION OF pH/ORP

This chapter describes the screen operations of pH/ORP, the object to be measured. Further details of screen operations can also be found in section 1.2.

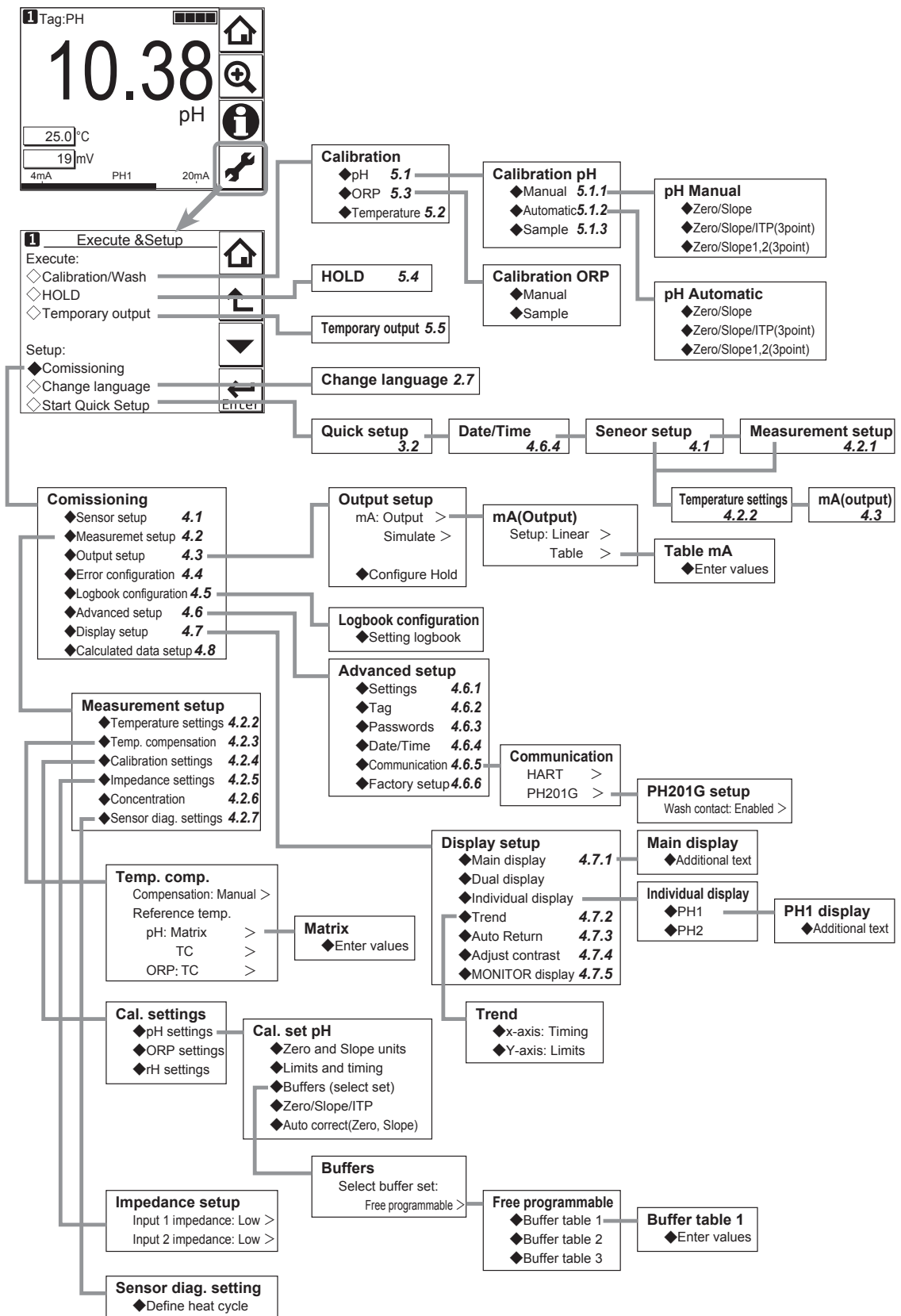

Figure 3.1 Menu structure of pH/ORP (the number after the item refers to the relevant section)

3

PH

---

## 3.1 Change language

The screen is set to display English at factory shipment; if you wish to use the FLXA202/FLXA21 in another language, first select a language as described in section 2.7.

## 3.2 Quick setup

The Quick setup screen is used to set up the basic items you want to set up first, such as the date/time and sensor settings. The detailed settings are described in chapter 4, Commissioning.

You may leave the Quick setup now and return to it later; however, it is recommended to perform the quick setup first.

Each time the FLXA202/FLXA21 is started up, this screen is displayed. If it is not necessary to

change the setup, press No or .

### NOTE

---

When no operation is performed for 10 minutes or 60 minutes (depending on the setting of “Auto Return”), the display except Trend display automatically changes to the Monitor display (or to the Main display or the Home display when the MONITOR display is disabled).

---

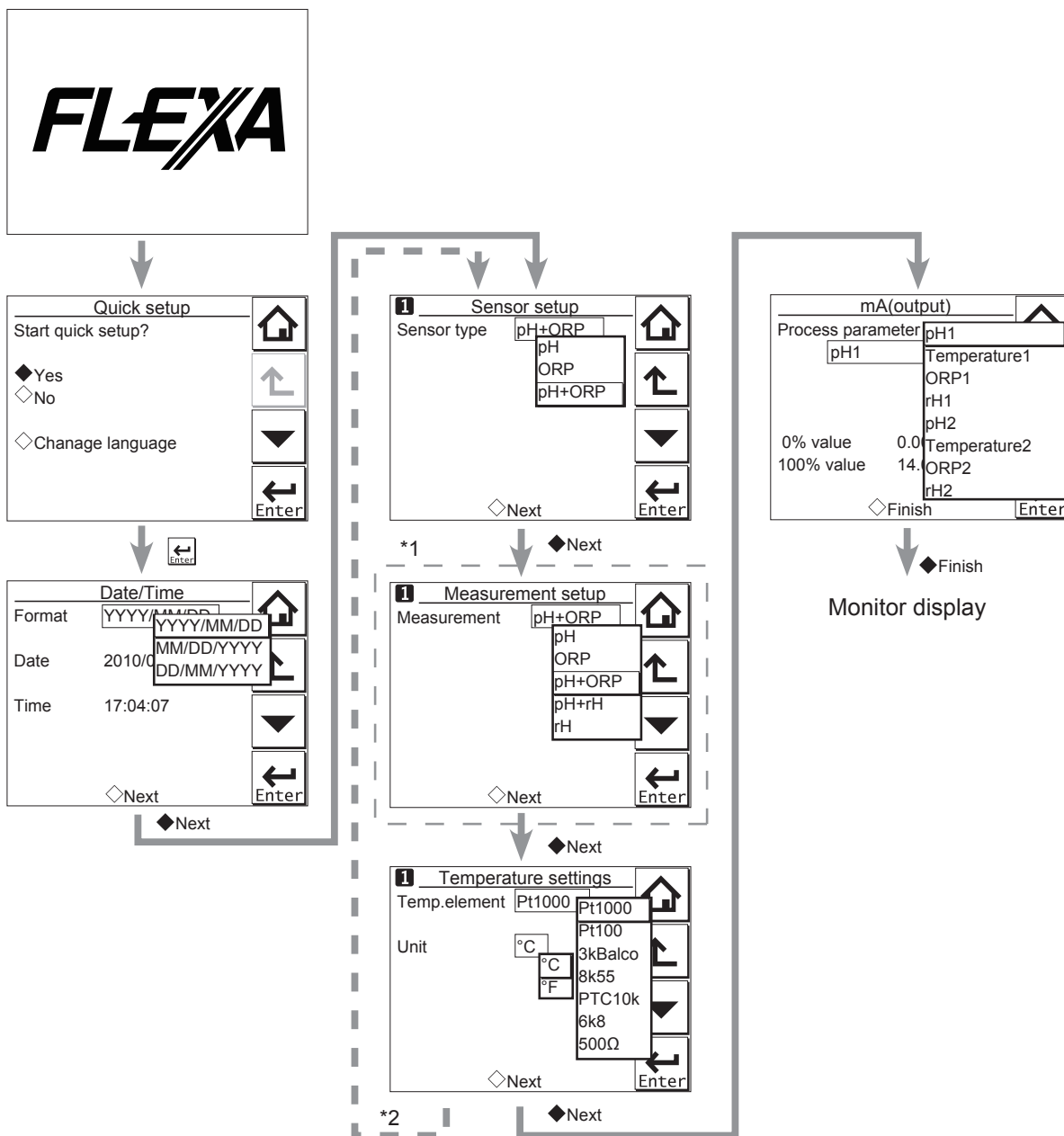

\*1: The Measurement setup screen appears only when "pH + ORP" is selected on the Sensor setup screen.  
 \*2: If two sensors are connected, the second sensor can also be set up.

**Figure 3.2 Quick setup**

### ■ Date/Time

The date display format can be selected from among the three types.  
 Enter the date or time of day by using the numerical keys.  
 For details, see section 4.6.4.

### ■ Sensor setup

Select a suitable electrode from among the displayed electrode types and set it up.  
 For details, see section 4.1.

### ■ Measurement setup

Select a suitable measurement parameter from among those displayed and set it up.

Measurement parameter setup can be made only when “pH + ORP” is selected on the Sensor setup screen.

For details, see section 4.2.1.

### ■ Temperature settings

Select a suitable temperature element from among those displayed and set it up.

Celsius (°C) or Fahrenheit (°F) temperature scale can be selected.

For details, see section 4.2.2.

### ■ mA (output)

Select a suitable process parameter from among those displayed and set it up.

For example, the mA output of pH has been set to 0 – 14 pH at factory shipment. If the resolution needs to be improved, set a suitable value for the process.

For details, see section 4.3.

## 3.3 Home display, Main display and Monitor display

Pressing  changes the screen to the Main display shown in Figure 3.3 (or the Home display shown in Figure 3.4).

If two sensors are connected, pressing  on the Main display changes the display to the Home display shown in Figure 3.4.

If only one sensor is connected,  is grayed out and disabled on the Main display.

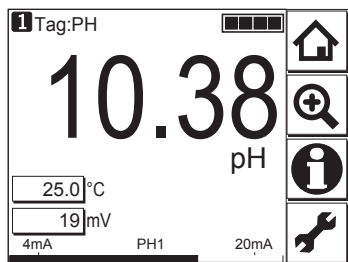

Figure 3.3 Example of main display

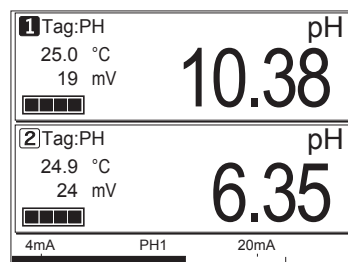



Figure 3.4 Example of home display

On the Home display, pressing  of the 1st sensor (top) or 2nd sensor (bottom) causes the display of the selected sensor to appear on the Main display.

On the Main display, pressing  of the 2nd or 3rd display item causes the 1st display item to be replaced by the selected item.

**NOTE**

Measured values to be displayed in the 1st to 3rd display items depend on the user definition (see section 4.7.1). For example, on the default condition of pH measurement, the 1st display item is pH, the 2nd display item is temperature, and the 3rd display item is empty.

When the MONITOR display is enabled (see section 4.7.5), pressing the 1st display item on the home display or the main display changes the display to the Monitor display with the enlarged font of the measured value.

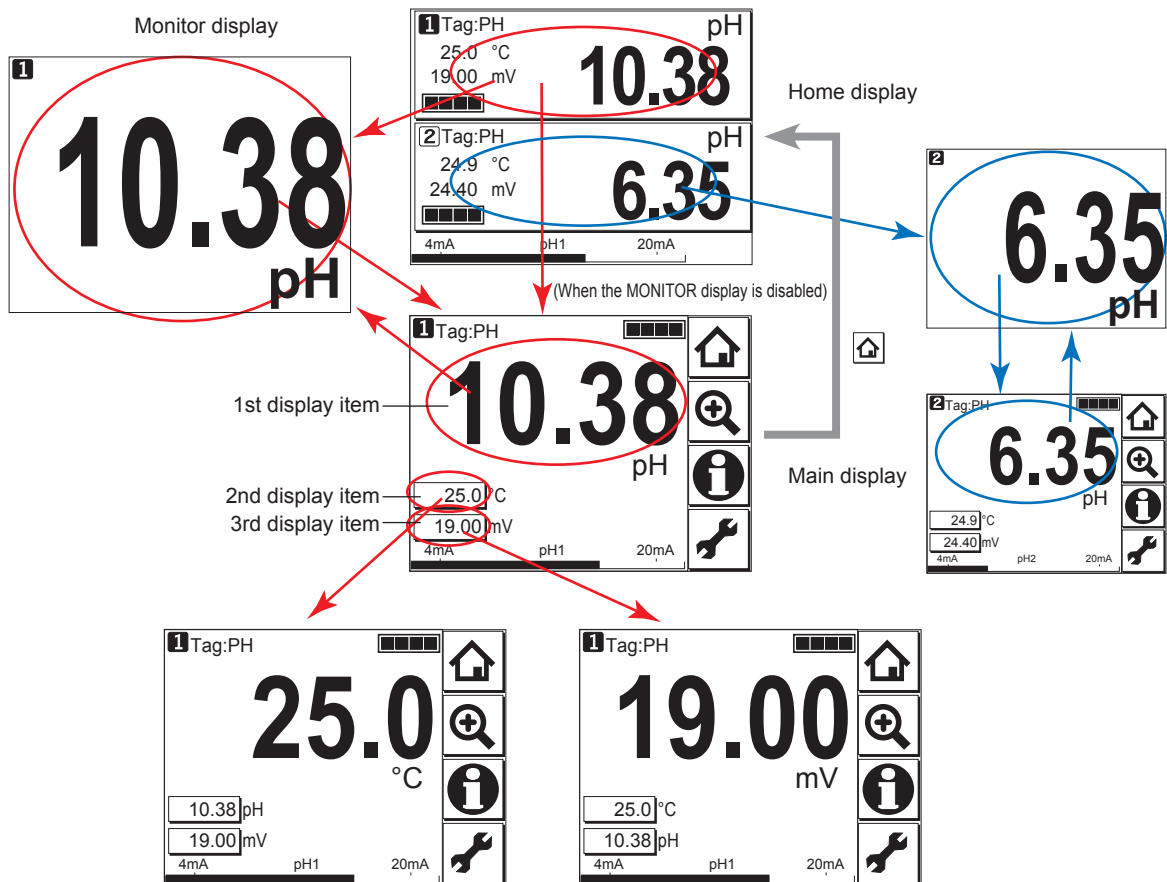

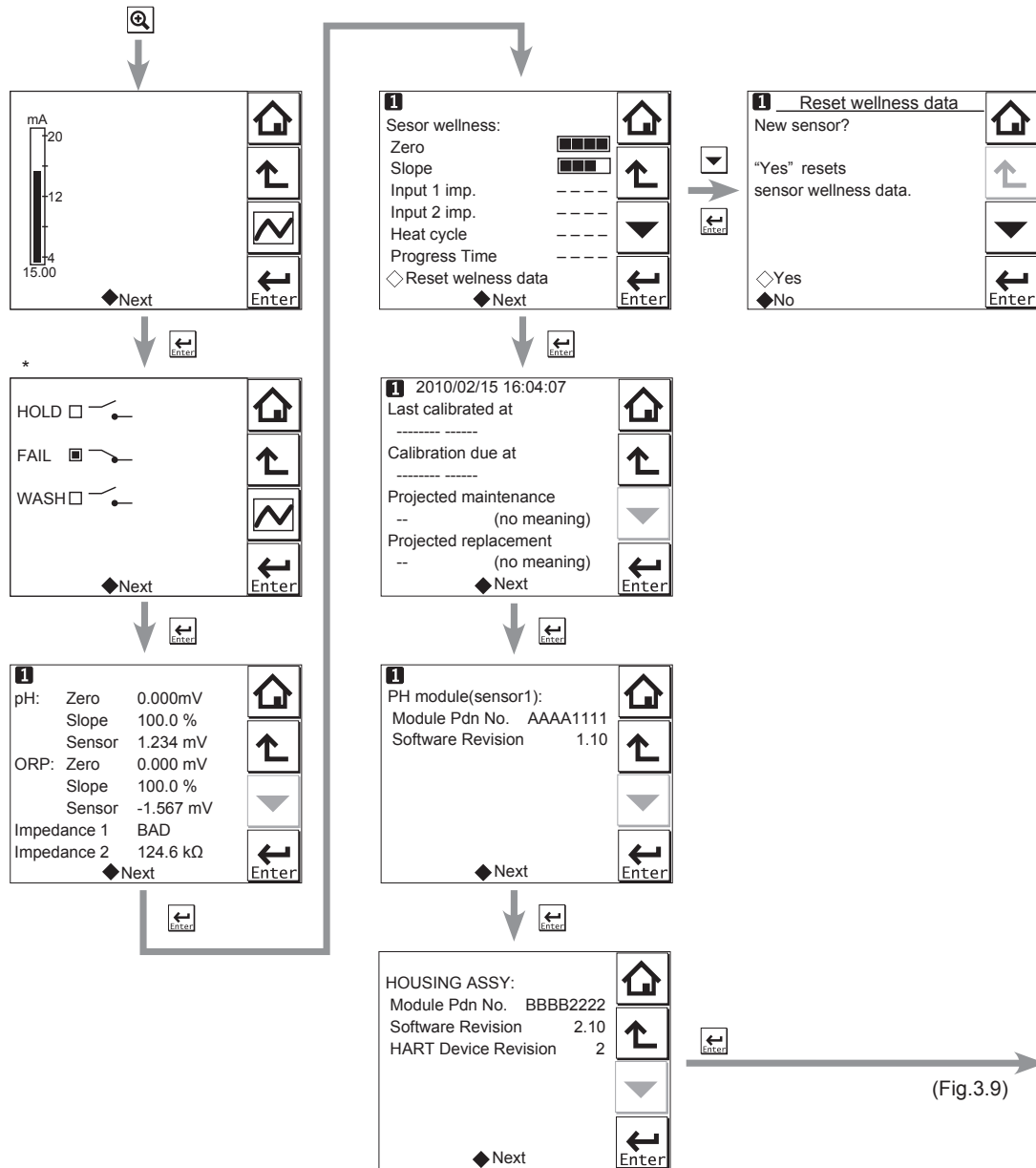

Figure 3.5 Change display

### 3.4 Zooming in on details

Pressing  on the Main display allows you to check detailed instrument information (instrument information such as setup, sensor diagnosis, calibration, and module productions number) through a transition of screens as shown in Figure 3.6.

In case of trouble, when you contact your nearest Yokogawa service center, please inform us of the module and FLXA202/FLXA21 software revision displayed on the Detail screen and other display information as well as the module productions number indicated on the nameplate attached to the instrument.



\*: This screen is displayed only if the PH201G distributor is used and "PH201G" is selected in communication setup.

Figure 3.6 Detail display

### ■ Current output mA

= current output in mA. The range and function of this mA output can be set in Commissioning → Output setup → mA.

For details, see section 4.3.

### ■ Contact status

This screen is displayed only if the PH201G distributor is used and "PH201G" is selected in communication setup.

## ■ PH (ORP)'s zero, slope, and sensor, and Impedance

### ● Zero

= calibrated sensor offset in mV. Theoretically, the sensor reads 0 mV in a buffer solution of pH 7. The ZERO value indicates the condition of the sensor. The trend of ZERO drift of the sensor is used to predict the lifetime of the sensor.

ZERO can also be displayed in pH units and then it represents the pH value where the sensor output is 0 mV at 25°C. Setting can be made in Commissioning → Measurement setup → Calibration settings → Zero and Slope units.

Setting of the zero value can be made in Commissioning → Measurement setup → Calibration settings → Zero/Slope/ITP. For details, see section 4.2.4.

### ● Slope

= calibrated efficiency of the sensor unit as a percentage of the theoretical slope of the sensor unit. The theoretical slope follows the NERNST equation and is 59.16 mV/pH (at 25°C). The SLOPE can be calibrated only after a two-point calibration in buffer solutions with a different pH value. A low slope indicates that the sensor is not clean or is faulty.

The SLOPE can also be displayed as a mV/pH value at 25°C if the user has defined this variable as mV/pH in Commissioning → Measurement setup → Calibration settings → Zero and Slope units.

Setting of the slope value can be made in Commissioning → Measurement setup → Calibration settings → Zero/Slope/ITP. For details, see section 4.2.4.

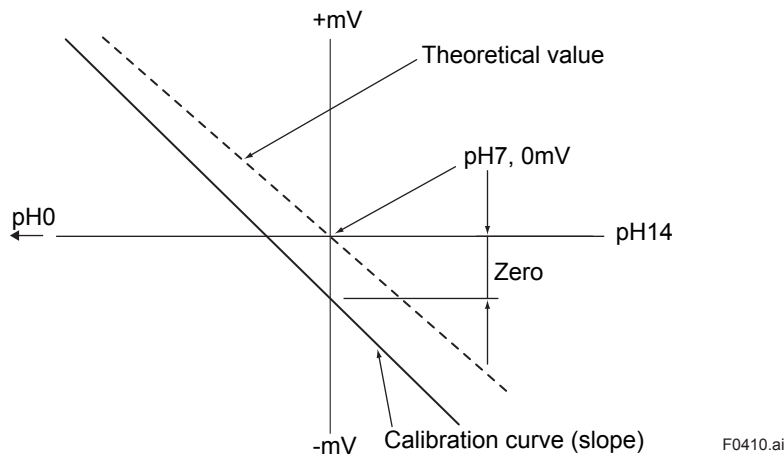

Figure 3.7 Zero/slope

### ● Sensor

Represents the electromotive force of the sensor.

### ● Impedance 1

For a PH sensor, "Impedance" shows electrical resistance of the glass membrane electrode. The FLXA202/FLXA21 checks the impedance to know damage of the electrode.

For an ORP sensor, "Impedance" shows electrical resistance of metal electrode.

The FLXA202/FLXA21 checks the impedance to know the surface condition of smudge and the snapping of sensor wires. In case of "Input Impedance setting" is "High" and the measured input-1 impedance value is higher than 100 kΩ, the display shows "MΩ RANGE". The measured input-1 impedance value is lower than 100 kΩ, display shows "BAD".



If both impedance measurements are disabled (Error setting: Off), the display shows “- - - - (bar)”. If either impedance measurement 1 or 2 is enabled, the display shows both the impedance values.

### ● Impedance 2

Impedance shows the electrical resistance of the reference electrode liquid junction. The liquid junction forms the electrolytic contact between the reference electrode and the measuring electrode, so it must be kept clean and filled with conductive electrolyte. Otherwise the measurement will suffer from instability, drift and measuring errors. The electrical impedance is one of the most important.

In case of “Input Impedance setting” is “High” and the measured input-2 impedance value is higher than 100 k $\Omega$ , the display shows “M $\Omega$  RANGE”. The measured input-2 impedance value is lower than 100 k $\Omega$ , display shows “BAD”.

If both impedance measurements are disabled (Error setting: Off), the display shows “- - - - (bar)”. If either impedance measurement 1 or 2 is enabled, the display shows both the impedance values.

## ■ Sensor wellness

At the Sensor wellness window, the soundness of a module is displayed. A larger number of ■ in each gauge indicates that the parameter concerned is sound. A gauge is indicated for only those parameters whose sensor wellness setting is “enabled,” while a bar (----) is displayed if the sensor wellness setting is “disabled.”

Sensor wellness setup can be made in Commissioning → Measurement setup → Sensor diag. settings. For details, see section 4.2.7.

The “Reset wellness data” button can reset wellness data.

When a sensor or an electrode is exchanged or replaced, sensor wellness data should be reset.

## NOTE

When a sensor is replaced, the replacement can be recorded manually into a logbook. (Refer to the figure 3.9.)

## ■ Last calibrated

= date on which the last sensor calibration was performed. The displayed value of the Zero is the result of this calibration. The displayed value of Slope was calibrated on this date only if the last calibration was a 2-point calibration.

## ■ Calibration due

= the date when the calibration must be done next according to the settings of the calibration interval. The calibration intervals are set in Commissioning → Measurement setup → Calibration settings → Limits and timing.

## ■ Projected maintenance

The projected maintenance function predicts the date when the sensor unit will need recalibrating for maintaining measurement accuracy. The function checks the input-2 impedance (reference impedance) every 24 hours.

The function predicts the date when the input-2 impedance will cross the upper or lower limits, and indicates the date and its status (the status is displayed in parentheses).

As shown in Figure 3.8, the date is predicted based on the intersection point of the upper or lower limits and the extrapolated line of the values obtained by the least squares method.

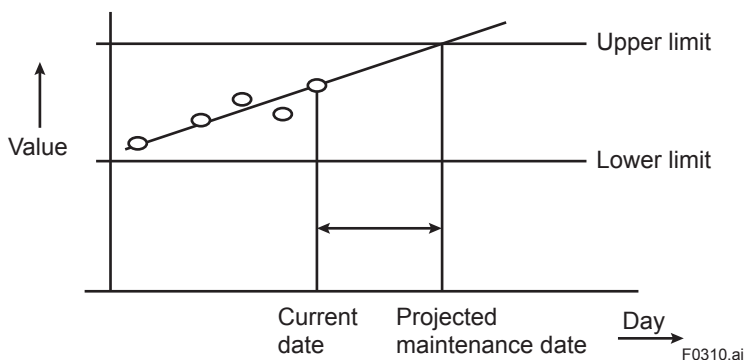

Figure 3.8

The status shows the certainty of the projected maintenance date in terms of the correlation coefficient R. Tables 3.1 and 3.2 show respective display patterns.

Table 3.1 Display pattern of the projected maintenance date

Projected date	--	0-1 month	1-3 months	3-6 months	6-12 months	Over 1 year
----------------	----	-----------	------------	------------	-------------	-------------

--: cannot be predictable due to insufficient data

Table 3.2 Display pattern of the status

Status	(----) ( $R < 0.50$ )	(Poor) ( $0.50 \leq R < 0.70$ )	(Reasonable) ( $0.70 \leq R < 0.85$ )	(Excellent) ( $0.85 \leq R < 1.00$ )
--------	--------------------------	------------------------------------	--	---

### ■ Projected replacement

The projected replacement function predicts the date when the sensor will need replacing for maintaining the measurement accuracy, based on the pH zero and pH slope on each calibration, and reference impedance (input-2 impedance) after each calibration. The projected replacement date is predicted based on these parameters stored upon calibration, and displayed the same as that of projected maintenance. For details, see the description about the projected maintenance. Since three parameters (pH zero, pH slope, and input-2 impedance after calibration) are used for this projection, the nearest coming day is selected as the projected replacement date from the extrapolated line of the values obtained by the least squares method.

### ■ PH module (sensor)

With this screen, you can check the module productions number and software revision of the installed module.

### ■ HOUSING ASSY

With this screen, you can check the module productions number, software revision, and HART device revision of the housing assembly.

### ■ Read logbook

The FLXA202/FLXA21 has two types of logbook per sensor to store history information on events, such as changed settings and calibrations.

By selecting one of the logbooks that you wish to check, you can retrieve and check this information. Storage of history information on each event in a logbook or which logbook to use for storage can be set up on the Configure logbook screen. For details, see section 4.5.

History information on events are automatically stored on the preset conditions.

In addition to this storing, following three messages can be manually stored in the logbook;

"Sensor washed by hand", "Module replaced", "Sensor replaced"

To store these messages, press  and select one of three messages from the Item on the Memorandum screen. Its event date/time will be the time when a message is selected and entered.

When a password for Commissioning is set on the passwords' setup, pressing  requires entering the password. (Refer to the section 4.6.3.)

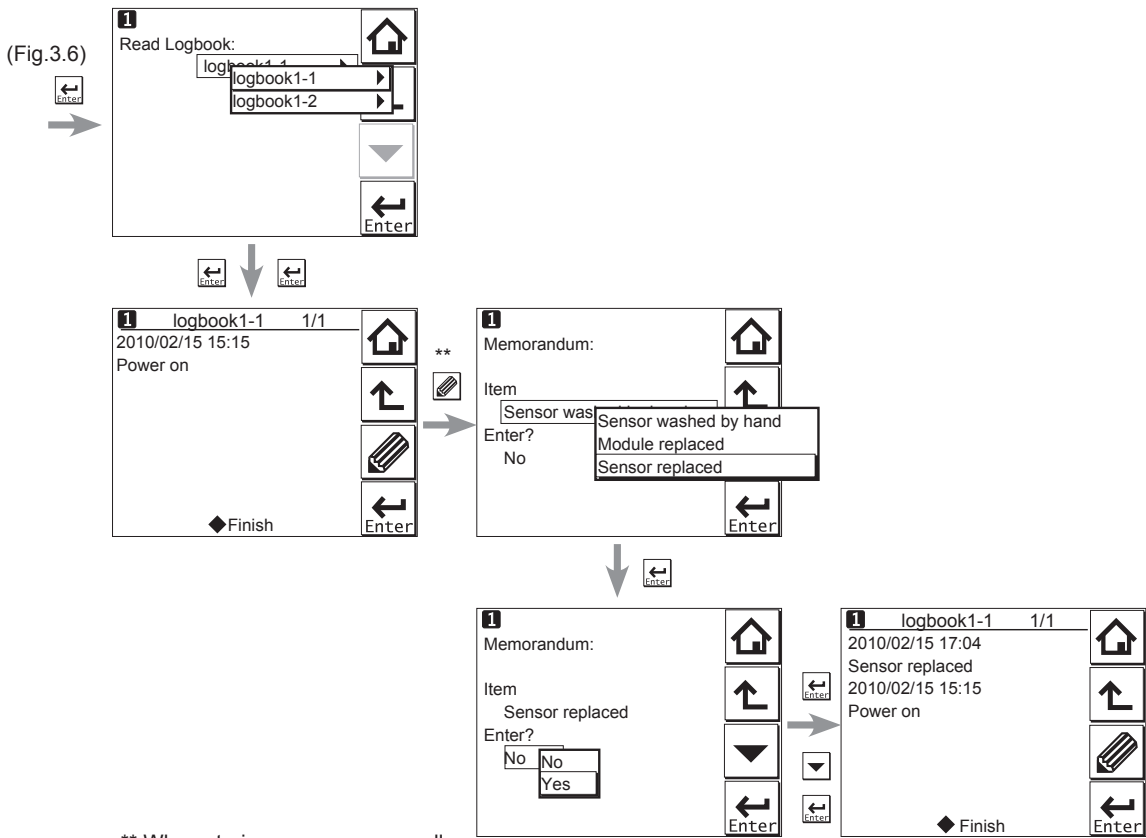



Figure 3.9 Detail display (continued)

### 3.5 Trend graphics

Pressing  on the Zoom display changes the display to a graphical mode in which the average measured value is shown on a time scale. The "Live" value is also digitally displayed in a text box. The time scale (X-axis) and the primary value scale (Y-axis) are set in the "DISPLAY SETUP" menu (Section 4.7.2).

The screen displays the trend of up to 41 averages of the measurement for each time interval. The FLXA202/FLXA21 samples the measurements every second. The trending graphic also shows the maximum and minimum measured values in that interval.

For example, if the time scale is set to 4 hours, then the trend is shown for 4 hours prior to the actual measurement. Each point on the trend line represents the average over  $4 \times 60 \times 60 / 41 = 351$  measurements (seconds).

### NOTE

Updating the trend screen setup resets the current trend graph and starts a new one.

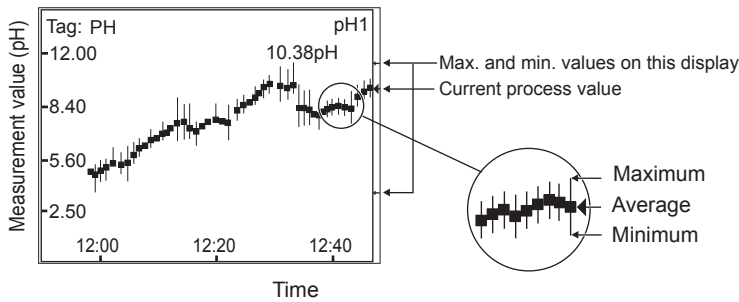

Figure 3.10 Trend screen

The 1st display item data on the Main display is shown as a graph. Touching any point on the display changes the display to the 2nd display item data (and to the 3rd display item data if set) and then returns to the Main display.

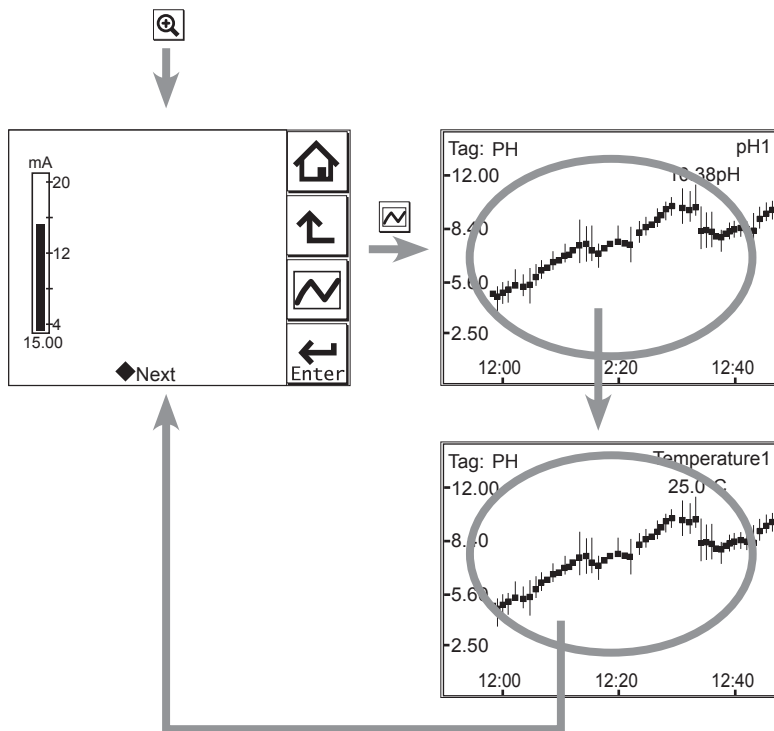



Figure 3.11 Trend graphics

## 3.6 Instrument status screen

In the  field of the Main display, the  (Warning) or  (Fault) sign appears according to the instrument status. Upon pressing the displayed button, detailed information of the relevant status appears.

See “ Information button” on page 1-10.

## 3.7 Calibration and Commissioning

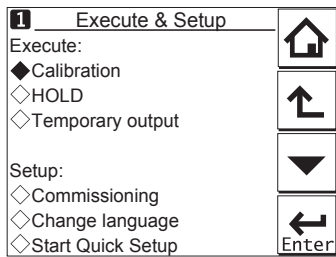

Allows you to calibrate and configure the instrument. These operations can be protected with a password.

For details on the password, refer to section 4.6.3.



**Figure 3.12** Execute & Setup

Pressing  changes the display to the Execute & Setup screen.

Browse through the menu items by pressing  until you find the desired menu and then press  to enter that menu. It is also possible to enter a desired menu by pressing the  $\diamond$  symbol beside the menu item.

For calibration (HOLD, Temporary output), read chapter 5, and for commissioning, read chapter 4.

# 4. COMMISSIONING OF pH/ORP

This chapter describes how to check and change settings from the Commissioning screen. When you move to the Commissioning screen, the output is held.

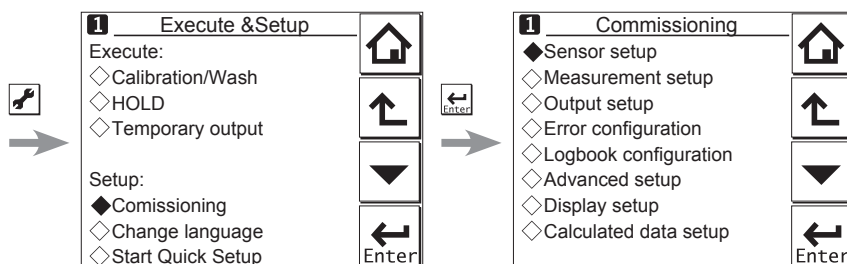

Figure 4.1 Example of the commissioning screen (for two modules)

Operations in Commissioning can be password-protected. If you set up a password, always take a note of it. For details on setting a password, see section 4.6.3.

Figure 3.1 shows the commissioning procedure. Before changing any parameters, read the relevant sections in this document and understand how the change of parameters affects the performance of this instrument. If you set a wrong value, return it to the default setting or value and then set it again.

On the first startup, the parameters are all default values configured at the factory. Check the parameters in Table 4.1 and change any of them if necessary depending on the sensors to be connected and the purpose of use.

Set "Sensor type" first. Some measurement parameters and relevant options change accordingly. The underlined parameters in Table 4.1 are used for the quick setup.

The default values and setting ranges are listed in the "User setting table of pH/ORP" in the attached CD-ROM.

After confirming that the instrument operates normally with the parameters, print out the "User setting table of pH/ORP" and write down these parameters in the column of User Settings.

All user parameters can also be saved in the instrument.

Select Commissioning → Advanced setup → Settings → Save user settings (see Section 4.6.1).

**Table 4.1 Menu Structure and Default Values in “Commissioning”**

Parameter		Ref. sect.		
Sensor setup	<u>Sensor type</u>	4.1		
Measurement setup	<u>Measurement</u>	4.2.1		
	Temperature setting	<u>Temp. element</u>	4.2.2	
	Temp. compensation	Compensation	4.2.3	
		Reference temp.		
		Process Temp. Compensation		
	Calibration settings	pH settings	<u>Zero and Slope units</u>	4.2.4
			Limits and timing	
			Buffers (select set)	
			<u>Zero/Slope/ITP</u>	
			Auto correct (Zero, Slope)	
		ORP settings	Limit and timing	
	rH settings	<u>Zero/Slope</u>		
	Impedance settings		4.2.5	
Concentration	Unit	4.2.6		
Sensor diag. settings	Input 1 imp.:	4.2.7		
	FINE			
	Input 2 imp.:			
	Process time			
	Heat cycle:			
	Define heat cycle			
Output setup	mA	Output	<u>Process parameter</u>	4.3
			Setup	
		Linear	<u>0 % value</u>	
			<u>100% value</u>	
		Table		
		Burn		
		Damping time		
		Simulate	Simulation perc.	
		Configure Hold		
	Error configuration		4.4	
Logbook configuration		4.5		
Advanced setup	Settings	4.6.1		
	Tag	4.6.2		
	Passwords	4.6.3		
	Date/Time	4.6.4		
	Communication	HART	4.6.5	
		PH201G		
	Factory setup	4.6.6		
Display setup	Main display (Dual display, Individual display)	4.7.1		
	Trend	4.7.2		
	Auto Return	4.7.3		
	Adjust contrast	4.7.4		
	MONITOR display	4.7.5		
Calculated data setup	Function	4.8		

**NOTE**

All the parameters for the quick setup (underlined ones in Table 4.1) are crucial for measurement. If you change any of them, other parameters may be initialized. For the parameters that may initialize other values, see Appendix 1.

## 4.1 Sensor setup

“Sensor type” setup is determined by the sensor to be connected to the instrument. Select one of the following three sensor types:

- pH: Only pH is measured. The glass electrode (input 1) is connected to terminal 15 and the reference electrode (input 2) is connected to terminal 13.
- ORP: Only Redox is measured. The metal electrode (input 1) is connected to terminal 15 and the reference electrode (or glass) (input 2) is connected to terminal 13.
- pH + ORP: Both pH and ORP are measured simultaneously. The glass electrode is connected to terminal 15, the reference electrode to terminal 13, and the metal electrode to terminal 14. This setup also allows rH to be measured.

For best results, connect a liquid earth to terminal 14. For details of the wiring connections, see Section 2.5.1. If there is no liquid earth, the sensor diagnostic function is disabled; set all of “Impedance 1 too high/low” and “Impedance 2 too high/low” in “Error configuration” to Off so that no related error is caused.

### NOTE

The selection of “Sensor type” determines the menu structure throughout the instrument.

When pH + ORP is specified as the sensor type, the object under measurement will be displayed at the top of “Measurement setup.”

If the sensor type is changed from pH to ORP, part of the relevant setup is reset, requiring reconfiguration.

When ORP is specified, and when an ORP sensor doesn't have any temperature element, set both of “Temperature too high/low” in “Error configuration” to Off so that no related error is caused. (Refer to the section 4.4.) Without temperature input, a temperature shown on the Main display or the Home display is the maximum or the minimum temperature of the temperature element's range set on the Temperature settings. Setting in “Display setup” can make temperature value on the display not to be displayed. (Refer to the section 4.7.)

## 4.2 Measurement setup

This section describes how to set up various parameters relating to measurements.

Measurements are performed based on the measurement parameter setup.

For measurement setup, part of the menu structure of settable items changes depending on the “Sensor type” selected in “4.1 Sensor setup.”

### 4.2.1 Measurement

If “pH” or “ORP” is selected in “Sensor type,” a measurement type does not need to be selected and it is not displayed.

If “pH + ORP” is selected in “Sensor type,” five measurement types can be selected for the “Measurement” item at the top of the Measurement setup screen. Select a suitable measurement type for the application.

Moreover, associated items are added to parameters in “Error configuration,” “Display setup,” etc.; check the setting condition of each item.



## 4.2.2 Temperature settings

Select the temperature element used for compensation from among Pt1000, Pt100, 3kBalco, 8k55, PTC10k, 6k8, and 500 $\Omega$ . Select the same type as the temperature element that is actually connected.

Celsius ( $^{\circ}\text{C}$ ) or Fahrenheit ( $^{\circ}\text{F}$ ) temperature units are available. If the unit is changed, the following values are also recalculated automatically to the new unit:

- Manual temp.
- Reference temp.
- Temp. coefficient
- Temp. ranges in the matrix

## 4.2.3 Temperature compensation

ORP measurement involves no temperature input. No setting is required on the temperature compensation. Process temperature compensation is effective if "T.C. ORP mV/ $^{\circ}\text{C}$ " in "Temp. Coef." is set.

### ■ Temperature compensation

This compensation of pH value is performed on the Nernst equation.

Two methods can be used: Automatic and Manual. Select Automatic when a temperature element is used, or select Manual when a manually set temperature is used.

#### NOTE

When Manual is selected on the Temperature compensation, a process temperature should be set in the "Manual temp." A temperature shown on the Main display or the Home display is this manually set temperature.

### ■ Reference temperature

Set a reference temperature to which the measured pH value must be compensated. Normally 25 $^{\circ}\text{C}$  is used, so this temperature is chosen as the default value.

### ■ Process temperature compensation

Select a temperature compensation method. "None" does not perform the temperature compensation.

If "pH" is selected in "Sensor type," choose process temperature compensation from among None, TC, Matrix, and NEN6411. If "ORP" is selected in "Sensor type," choose it from among None and TC.

#### ● TC

This method uses the linear compensation function.

It is possible to adjust the temperature coefficient (TC) factor directly. If the temperature coefficient factor of the sample liquid is known from laboratory experiments or has been previously determined, it can be entered here.

This TC is a pH variation to 1  $^{\circ}\text{C}$  ( $\Delta\text{pH}/\Delta\text{T}$ ). Adjust the value between -0.1 to 0.1 pH/ $^{\circ}\text{C}$ .

In combination with the reference temperature setting, a linear compensation function is obtained, which is suitable for all kinds of chemical solutions.

● **Matrix**

Matrix means a temperature compensation which uses the temperature compensation matrix. The temperature compensation matrix is a table of pH values at various temperatures corresponding to the pH values at the standard temperature. For details, see Appendix 1.

When the temperature or the precompensated pH value is out of the range of the temperature compensation matrix, the temperature compensation error (warning) will be issued. This is not a device error.

In this case, however, the temperature compensation is performed by extrapolation.

**NOTE**

To display the precompensated pH value, set the Process Temp. Compensation to "None".  
 Select Measurement setup → Temp. compensation → Process Temp. Compensation.

● **NEN6411**

This algorithm takes into account the dissociation of water in strong acid and strong alkaline solutions. It is particularly useful for pH measurement of boiler feed water.

**4.2.4 Calibration settings**

The screen flow differs depending on the combination of objects to be measured.

Calibration settings for a pH converter involve slope (sensitivity), zero (aspot), and ITP (isothermal point). Figure 4.2 shows the pH value against the mV output of the sensor. The characteristic for pH measurement is an offset also known as aspot [mV] or zero [pH] and a Slope [% , mV/pH]. For an ideal sensor, the theoretical slope is 59.16 mV/pH at 25°C. The slope can be entered in mV/pH or as a percentage of the theoretical slope (100% corresponds to 59.16 mV/pH). ITP represents a pH value where the output of the sensor does not change with temperature. Note that slope and zero are defined at 25°C.

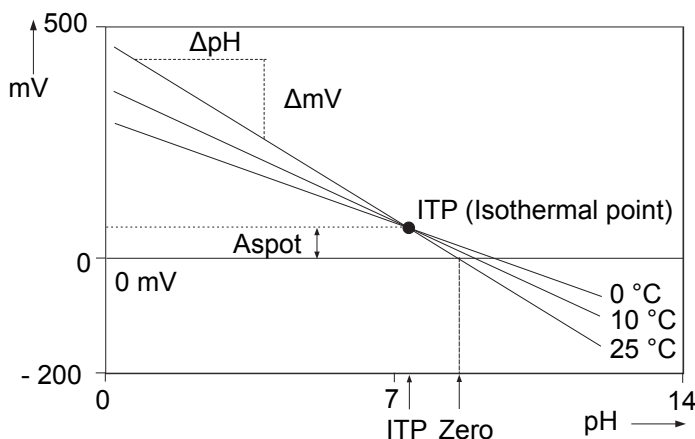

Figure 4.2 Calibration parameters

■ **pH settings**

● **Zero and Slope units**

Zero is an alternative to Asymmetry Potential. The method of zero (aspot) unit conforms to the DIN standard for IEC 60746-2 instruments. Zero is defined in pH or mV.

The unit of Slope (sensitivity) is mV/pH or % (with the theoretical value as 100%).

- **Limits and timing**

**Zero High/Low**

Set the high and low limits of Zero (aspot). During calibration, it is checked whether the new zero exceeds these high and low limits. Narrowing the band will prevent bad calibration procedures and calibration of bad sensors, which results in higher accuracy. The default values should be adjusted to suit the application and the “users” criterion.

**Slope High/Low**

Set the high and low limits of Slope (sensitivity). During calibration, it is checked whether the new slope exceeds these high and low limits. Narrowing the band will prevent bad calibration procedures and calibration of bad sensors, which results in higher accuracy. The default values should be adjusted to suit the application and the “users” criterion.

**Step Range**

Set the range over which the stability of a measured value is checked. If variations of a measured value over the stabilization time are within this set value, the measured value is judged to have stabilized.

**Stabilization time**

During calibration, the stability of the pH value is constantly monitored. When variations of the pH value are within a value set in Step Range over this stabilization time set here, the value is regarded as being stable. If the pH value does not stabilize within 10 minutes, calibration is aborted.

**Calibr. interval**

Set the interval in which a new calibration must take place. If the interval set here is exceeded, the instrument will be notified according to the setting in “Calib. time exceeded” in the error configuration.

- **Buffers (select set)**

Calibration is made using standard calibration buffers. We recommend the NIST (JIS equivalent) standard buffers for highest accuracy, but the user is free to select DIN 19267, US, or a user-defined buffer. The standard buffers can be found in Appendix 1.

Three types of user-defined buffer tables can be defined. On the Free programmable screen, select a buffer table that you wish to set up. When a buffer table is selected on this screen, the Buffer table 1 to Buffer table 3 screens of the selected buffer table are displayed.

**Clear table?**

If you select “Yes” and press “Yes” when prompted to clear the table, the contents of the buffer table will be cleared, the display will return to the Buffer table screen automatically, and the “Table was cleared” message will be displayed. If you want to perform temperature compensation using the matrix after clearing the table, matrix values must be redefined.

**Check values?**

If you select “Yes,” a value check starts. When the check ends, the results will be displayed on the screen. When the results are normal, the “No error” message appears. In case of an error, error information is displayed.

- **Zero/Slope/ITP**

You can enter Zero (aspot), Slope (sensitivity), and ITP values directly in the screen displayed. These data can be obtained from the manufacturer of the probe, by the users laboratory, etc.

**NOTE**

It is not necessary to enter this data. In most cases, as the FLXA202/FLXA21 automatically does this while performing calibration, the feature is used in the case of special electrode systems or where calibration in the process environment is not possible. See Chapter 5.

● **Auto correct (Zero, Slope)**

This function calculates calibration coefficients from the transition of past calibration data (zero, slope) and compensates pH value using these calibration coefficients after the latest calibration. The default setting is “Disable.” To make the function effective, select “Enable.”

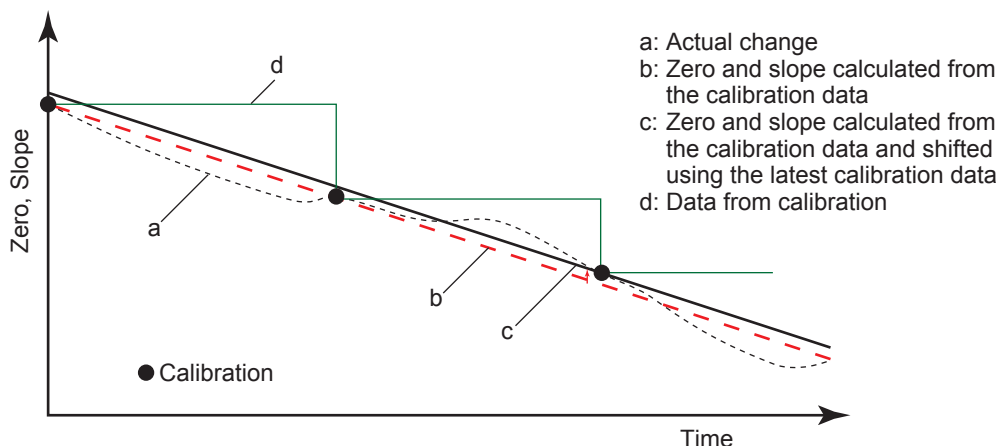

Figure 4.3 Auto correct

■ **ORP settings**

● **Limits and timing**

**Zero High/Low**

Zero (aspot) high and low limits. During calibration, it is checked whether the new zero exceeds these high and low limits. Narrowing the band will prevent bad calibration procedures and calibration of bad sensors, resulting in higher accuracy. The default values should be adjusted to suit the application and the “users” criterion.

**Slope High/Low**

Slope (sensitivity) high and low limits. During calibration, it is checked whether the new slope exceeds these high and low limits. Narrowing the band will prevent bad calibration procedures and calibration of bad sensors, resulting in higher accuracy. The default values should be adjusted to suit the application and the “users” criterion.

**Step Range**

Set the range over which the stability of a measured value is checked. If variations of a measured value over the stabilization time are within this setpoint, the measured value is judged to have stabilized.

**Stabilization time**

During calibration, the stability of the ORP value is constantly monitored. When variations of the ORP value are within a value set in Step Range over this stabilization time set here, the value is regarded as being stable. If the ORP value does not stabilize within 10 minutes, calibration is aborted.

**Calibr. interval**

Set the interval in which a new calibration must take place. If the interval set here is exceeded, the instrument will be notified according to the setting in “Calib. time exceeded” in the error configuration.

● **Zero/Slope**

You can enter zero and slope values directly.

## 4.2.5 Impedance settings

This screen is used to set the impedance relating to an input impedance check.

Input 1 impedance represents the “glass membrane impedance” of a pH sensor. In case of an ORP sensor, it represents “metal electrode impedance.” Input 2 impedance stands for “reference impedance.”

If you select “Input impedance: Low,” the display moves to the Input impedance screen, enabling you to set the high and low limits.

The FLXA202/FLXA21 has an impedance check, which is capable of monitoring the impedance of various sensor systems. In order to “fine tune” this diagnostic tool, it is necessary to set it up to match the sensors used.

The system can be set to measure the impedances of glass (input 1 impedance: high) and reference (input 2 impedance: low) electrodes. In applications that tend to leave deposits on the electrodes or to clog the reference sensor junction, the impedance check (set error configuration) on the reference sensor can be used to initiate an alarm, or to initiate the wash cleaning process, if one of the limits is exceeded. Sensors with a liquid earth use this liquid earth in impedance measurement. Sensors with a liquid earth that Yokogawa can provide include PH8EFP, PH8ERP, PH8EHP, OR8ERG, OR8EFG, etc. In pure water measurement using PH8EHP, the impedance of the solution to be measured is high; settings on the Error configuration screen should be set to Off so that the “Impedance 2 too high” error is not generated.

A sensor without a liquid earth cannot measure impedance. All settings on the Error configuration screen should be set to Off so that no “Impedance 1 too high” or “Impedance 2 too high” error is generated.

Sensors not equipped with a liquid earth that Yokogawa can provide include HA405, HA406, DPA406, DPA405, DPAS405, HF405, HA485, DPA485, etc.

This liquid earth refers to a metal pole built into a sensor or connected externally that contacts the solution to be measured and transmits the potential of this solution to the converter.

## 4.2.6 Concentration

Generally pH values are not converted into concentrations. Following linear conversion is not suitable for a lot of measurements.

The FLXA202/FLXA21 is capable of converting a measured pH value into concentration for display. Parameters required for concentration calculation can be arbitrarily set by the user. Those parameters are as follows:

- Unit: The default value is %. The unit can be selected from among mg/L, g/L, and ppm.
- pH: The default values are 0 and 14 pH (0 to 14). They are the pH zero and span required for conversion to concentration.
- Concentration: The default value are 0 and 100%. Concentration for each pH can be set.

Concentration can be assigned to the pH value zero and span individually.

## 4.2.7 Sensor diagnostic settings

This screen is used to set items relating to sensor diagnostics displayed on the screens invoked by pressing .

Gauges are displayed for only parameters that have been enabled in “Sensor diag. settings.” Parameters set to Disable are provided with a bar display.

The setting parameters include Input 1 imp., Input 2 imp., Progress time, and Heat cycle. When input impedance is set “High” (section 4.2.5), “FINE” value can be changed. When input impedance is set “Low”, its “High limit” and “Low limit” will be the limits for diagnostic. It is also possible to set the “Bad limits” of the progress time and heat cycle and the “Heat cycle temp” and “Heat cycle time” of the heat cycle.

## 4.3 Output setup

The general procedure is to first define the function of the output, Output or Simulate. Then, set the process parameters associated with the output. On the Output, an output of measured value is selected. On the Simulate, a simulation value can be set.

And, the parameters for HOLD function can be set on this setting.

- **Output**

The output signal is a current value specified by the following parameters.

**Process parameter**

The available process parameters depend on the selected “Sensor type” on the Sensor setup and the selected “Measurement” type on the Measurement setup.

The output of the selected process parameter is shown as a bar on the bottom of the Main display or the Home display. And its parameter symbol (for example, PH1 or Diff-pH) is shown above the bar, too. When a selected process parameter is displayed as a measurement value, the top left number or character is turned to be white number or character on black background (for example, **I** or **R(1)**). (Refer to the section 1.3.)

Process parameters can be selected from among:

- pH1, Temperature 1, and ORP1: 1st module’s measured values
- pH2, Temperature 2, and ORP2: 2nd module’s measured values
- Calculated\*1 and Redundant\*2: special output based on two inputs

\*1: Refer to the section 4.8, Calculated data setup.  
 \*2: Refer to the <Redundant system> below.

Calculated data and Redundant system are available when two modules are installed on the instrument. And, these functions are available when the “pH” (or the parameter including pH) or the “ORP” is selected on the “Sensor type” setting and the “Measurement” type setting. The parameter for the 1st module and the 2nd module should be the same. For wrong selection, an error is given.

When the process parameter is set at “Calculated” of “Redundant”, don’t change the “Sensor type” or the “Measurement” type. If it is changed, the process parameter will go back to the default.

<Redundant system>

On the Redundant system, when a sensor (Sensor 1) of the 1st module fails, the output is automatically switched to the output of the 2nd module.

After repairing the Sensor 1, manual reset of redundant system is necessary to return to the output of 1st module from the output of the 2nd module.

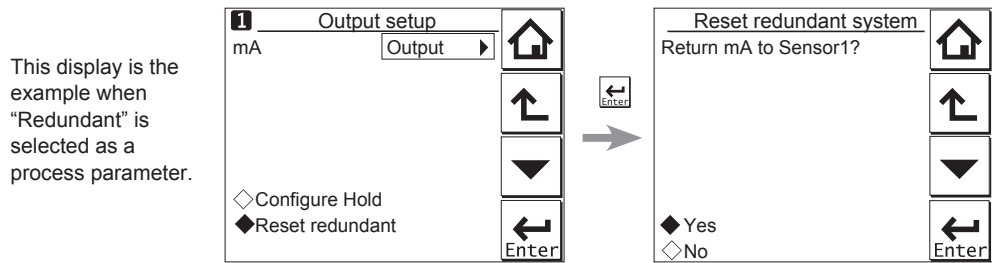
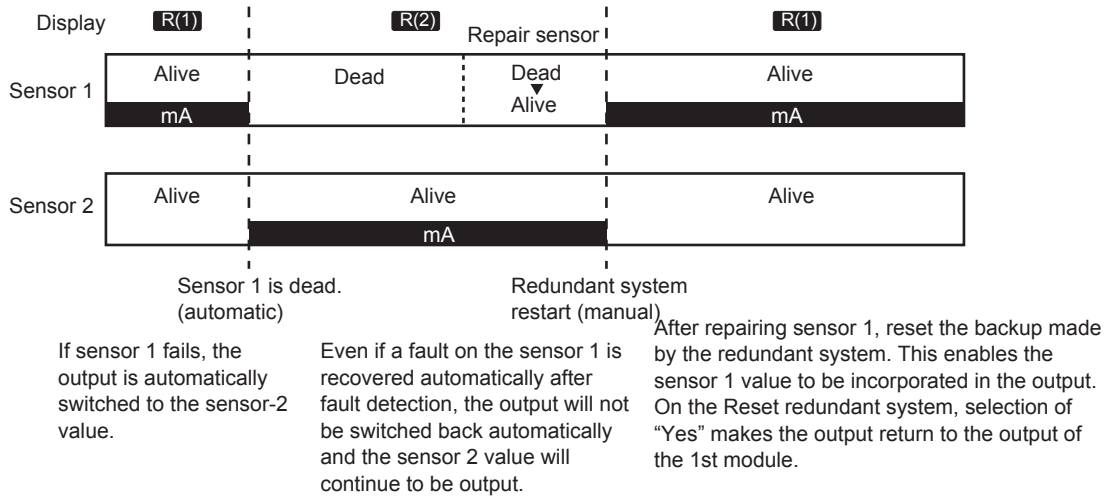

F0503\_2.ai

Figure 4.4 Redundant system

Setup

Select one of the output methods: Linear and Table.

Linear: Set the 0% and 100% values.

Table: This allows the configuration of an output curve by 21 points (5% intervals).  
(The 0% and 100% values must be entered.)

Burn

Select the designated output in case of a fault from among Off, Low, and High. See "4.4 Error configuration" to set the output.

Off: Output depends on the measured value.

Low: Output is fixed to 3.6 mA

High: Output is fixed to 22.0 mA.

Damping time

This is the time taken for a response to a step input change to reach 90% of the final value (attenuation time). Set this time in sec.

● Simulate

When this function is selected, an output of the instrument will be a fixed current value set in % of the output span. The output span range is -2.5% to 112.5% (3.6 mA to 22.0 mA).

When "Simulate" is selected, regardless of hold setting, the output is always simulated value.

## ■ Configure Hold

On the Configure Hold, settings are performed to hold of the mA output at a preset value. (Refer to the section 5.4.) This is enabled only if “mA” is “Output.”

During the Commissioning or the Quick Setup, the mA output is automatically held. The preset value depends on a setting on the “Last or fixed”.

“Last”: The preset value is a value measured just before hold condition.

“Fixed”: The preset value is a value set in the “Fixed value mA”.

When the “Fixed” is selected, set a mA value in the “Fixed value mA”.

Selection on the “Hold during Calibration/Wash” decides to activate or deactivate the hold function automatically during calibration or wash.

“Enabled”: Activation of the automatic hold function

“Disabled”: No automatic hold function

Only when the “PH201G” is selected on the Communication, the message of “Hold during Calibration/Wash” is displayed. On other selections, the message of “Hold during Calibration” is displayed.

## 4.4 Error configuration

In Error configuration, configure the statuses of various error causes.

This allows the system to notify the user of the occurrence of an error according to the status categories in the Error configuration.

Select a status category from among Off, Warn. (Warning), and Fault.

“Fault” automatically performs burn-out. When Burn has been set to Off (4.3 Output setup), only the error message is displayed.

“Warn.” displays an error message.

When selecting PH201G in the communication setting, make sure that the “Fail contact” setting is appropriate.

The settable causes of errors are determined based on the settings of the Sensor setup and Measurement setup, and a status category is set to the causes displayed in the Errors 1/3 to 3/3 screens.



**Table 4.2 Error configuration**

Display item	Description	Default
pH too high	The pH value exceeds 16.00.	Warn.
pH too low	The pH value is lower than -2.00.	Warn.
Temperature too high	Measured process temperature is higher than the maximum limit.	Warn.
Temperature too low	Measured process temperature is lower than the minimum limit.	Warn.
ORP too high	The ORP value is higher than 1500 mV.	Off
ORP too low	The ORP value is lower than -1500 mV.	Off
rH too high	The rH value is higher than 100.	Off
rH too low	The rH value is lower than 0.	Off
Matrix config. error	The temperature compensation matrix is not set properly (see Section 4.2.3).	Fault
Calib. time exceeded	Calibration time exceeds the calibration interval (see Section 4.2.4).	Off
Wash half-time error	The response to wash is abnormal.	Off
Impedance 1 too high	The sensor must be checked.	Off
Impedance 1 too low		
Impedance 2 too high		
Impedance 2 too low		

**CAUTION**

If canceling an error configuration could be risky, do not cancel it as a dangerous situation may result.

**NOTE**

The “Impedance 1 too high/too low” and “Impedance 2 too high/too low” error items are displayed in the Error configuration screen. In general, for a pH sensor, “Impedance 1” means “glass electrode,” and for an ORP sensor, it means “metal electrode.” “Impedance 2” represents the reference electrode in all cases. The “Impedance 1 too high/too low” and “Impedance 2 too high/too low” errors are applied to sensors with a liquid earth. Sensors with a liquid earth include PH8EFP, PH8ERP, PH8EHP, OR8ERG, OR8EFG, etc. For sensors not equipped with a liquid earth, these errors should all be set to Off; these sensors include HA405, HA406, DPA406, DPA405, DPAS405, HF405, HA485, DPA485, etc. Moreover, for measuring a solution with low conductivity such as when using a pH meter for pure water, set the “Impedance 2 too high” error to Off. Otherwise, no impedance can be detected.

**NOTE**

When ORP is specified as a sensor type in “Sensor setup”, and when an ORP sensor, such as OR8ERG and OR8EFG, doesn’t have any temperature element, set both of “Temperature too high/low” in “Error ” to Off so that no related error is caused. Due to the open input of temperature signal, a false error may happen as if temperature goes over a high limit or a low limit.

## 4.5 Logbook configuration

In “Logbook configuration,” the user configures information to be saved to a logbook or initializes the logbooks.

Logbooks are used to keep an electronic record of events such as error messages, calibrations, and programmed data changes. By referring to this log, users can, for instance, easily determine maintenance or replacement schedules.

In “Logbook configuration,” the user can select “Off,” “1-1,” or “1-2” for each item of interest to be logged. (For sensor 2, select “Off,” “2-1,” or “2-2.”) This can be done for items displayed on the Settings logbook 1/3 to 3/3 screens. Assigning 1-1 or 1-2 to each item allows information to be organized and logged in a logbook.

### NOTE

Some events such as power-on are saved into the logbook “1-1” or “2-1”. This logbook may be full earlier. It is recommended that important information be saved into the logbook “1-2” or “2-2”.

For “Erase logbook”, a specified logbook “1-1” or “1-2” can be erased individually.

When the “Warn if logbook full” is set to “Yes”, a warning is given when the logbook come to near full (maximum 13 pages).

### NOTE

When the logbook gets full, the oldest information is erased automatically.

## 4.6 Advanced setup

Advanced setup is used to set functions relating to matters other than measurements such as the selection of settings, tag setting, password setting for protecting calibration and commissioning operations, date setting, and communication setting.

(“Factory setup” is for service engineers only; there is no item to be set by the user.)

### 4.6.1 Settings

In “Settings,” select an item to be set as the default value from among “No action,” “Load factory settings,” “Save user settings,” and “Load user settings.”

When the default values are loaded, the instrument will be restarted. (In the case of “Save user settings,” it will not be restarted.)

The following parameters are not included in the defaults:

- Tag
- The contents of all logbooks

### NOTE

When the “Save user setting” is only selected, save of the user-set parameters will start at once.



To avoid wrong selection, operation in this Settings must be done by , not by touching the menu message.

If you select “Load factory settings,” the instrument will be set to the default settings at factory shipment.

When this item is selected, a screen prompting whether to restart is displayed. If this is no problem, press “Yes.” Then the “Loading ...” message appears and blinks and loading is started. When the factory settings have been loaded, the instrument will be restarted.

When “Save user settings” is selected, the current settings can be saved as the defaults.

When this item is selected, the user settings will start to be saved immediately. After saving the

parameters, press  or  to change the display because this save doesn't have restart function.

If “Load user settings” is selected, the settings saved as user settings can be set as the defaults.

When this item is selected, a screen prompting whether to restart is displayed. If this is no problem, press “Yes.” Then the “Loading ...” message appears and blinks and loading is started. When the user settings have been loaded, the instrument will be restarted.

## 4.6.2 Tag

A tag provides a symbolic reference to an instrument and is generally defined to be unique throughout the control system at one plant site. A tag can contain up to 12 alphanumeric characters. The default value is PH or FLXA21-PH. When two sensor modules are installed, each module can have their own tag numbers.

The tag is displayed at the top of the main and home displays.

## 4.6.3 Passwords

Calibration and commissioning operations can be separately protected by each password. To protect execute operations, enter a password in Execute's input field. To protect commissioning operations, enter a password in Commissioning's input field. By default, both input fields are empty. When a password input field is empty, operation is not password-protected. A password can contain up to 8 characters.

When you set a password, always take a note of it.

When a password is set, input of the password is necessary to enter the password-protected operation. After inputting the password, the display will change to an operator ID input display. When an operator ID is input, its operation is recorded into a logbook. The input of an operator ID is not necessary to enter the operation. An operator ID can contain up to 4 characters.

## 4.6.4 Date/Time

The Logbooks and trend graphs use the clock/calendar as a reference. The current date and time is set here. The time display format can be selected from among three types.

## 4.6.5 Communication

In “Communication,” select the communication setting from among None, HART, and PH201G.

The burn down current value is 3.6 mA.

### NOTE

To make the change of “Communication” valid, turn off the power supply once, and reboot.

In the case of “None,” there is not the problem even if you do not change it as “HART” of default value.

## ■ HART

Select this menu when HART communication (HART 5) is made.

In the HART setup screen, specify the network address and set up parameters for SV, TV, and FV.

(PV is linked with the “process parameter” setting in “Output settings” and cannot be changed here.)

- **Network address**

For 1-to-1 communication, leave the default value [0] unchanged. For multi-drop where multiple HART devices are connected on a bus, set addresses in 1 to 15. In this case, the mA output will be fixed to 4 mA.

- **PV**

PV is a parameter selected for analog output; it cannot be changed here.

- **SV, TV, FV**

The SV, TV, and FV parameters are items that the user must set up. Selectable items differ depending on the sensor type in “Sensor setup” and settings in “Measurement setup.”

If blank is selected for a parameter, items below that parameter must all be set to blank. If an item is blank, those below it cannot be set to a status other than blank.

For more information on HART communication, see the Technical Information (TI 12A01A02-60E) in the attached CD-ROM.

## ■ PH201G

Select this menu if the PH201G distributor is connected to the instrument.

In the PH201G setup screen, make settings for “Hold contact,” “Fail contact,” and “Wash contact.”

- **Hold contact**

Select Disabled or Enabled.

When this item is enabled, the output will be held according to the setting of “Hold type” on the Hold setup screen.

- **Fail contact**

Select a status from among “Fail + Warn,” “Fail only,” and “Disabled.”

This setting depends on the error configuration. See “4.4 Error configuration.”

“Fail” corresponds to “Fault.”

● **Wash contact**

Select Disabled or Enabled.

When this item is enabled, items for a wash can be set on the Wash settings screen.

In the Wash settings screen, set the interval time, wash time, and recovery time and setup of various washes.

Interval time: Set the wash interval in hours.

Wash time/measure time: Set the wash time in minutes. In a continuous wash, wash time is replaced by measure time.

Recovery time: Set the recovery time in minutes.

Manual wash: Select “Disabled” or “Enabled.”

When this item is enabled, a wash cycle can be activated manually. On the Calibration/Wash screen, press the “Start manual wash cycle” to perform a manual wash.

Imp2 wash: Select “Disabled” or “Enabled.”

When this item is enabled, a wash cycle can be started if the “Impedance 2 too high” error occurs with respect to the reference electrode.

Continuous wash: Select “Disabled” or “Enabled.”

A continuous wash cycle is started at the instant when this item is enabled. In a continuous wash, the “Measure time” and “Interval time” are reversed (see Figure 4.5).

When a continuous wash is disabled

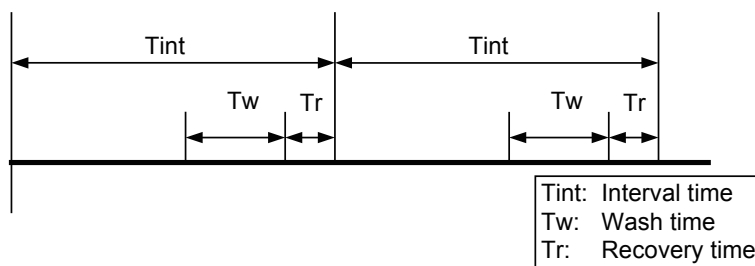

When a continuous wash is enabled

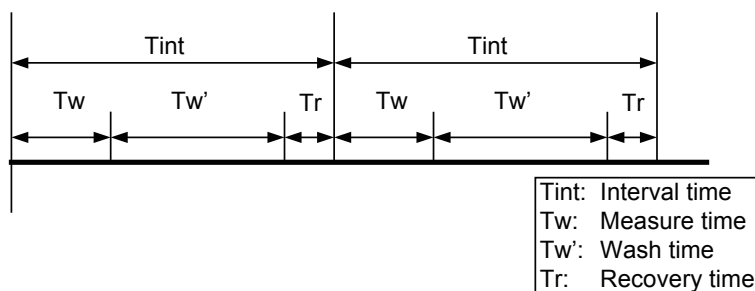

F050605\_2.ai

**Figure 4.5**

The instrument has a function for checking whether measurements are normally made after wash, allowing you to check a sensor response.

The wash recovery check is performed by making use of the time to recover half the wash-cycle pH change. The half the wash-cycle pH change recovery time replaces the relaxation time by the recovery time.

Whether to conduct the wash recovery check can be set on the Error settings 2/3 screen. Half the wash-cycle pH change refers to half the value ( $1/2\Delta\text{pH}$ ) of the difference ( $\Delta\text{pH}$ ) between the pH value during normal measurement of an example in Figure 4.6 and the pH value detected during wash. If the pH value during wash is greater than  $1/2\Delta\text{pH}$  when  $1/3 tR$  has elapsed, the electrode is assumed to be good. If it is smaller than  $1/2\Delta\text{pH}$ , then the electrode is assumed to be bad.

However, for applications where the pH during wash shows almost the same value as the normal pH, the difference will be approximately zero. In such a case, disable the wash recovery check. An example of such applications is the monitoring of waste water pH. If you select water jet cleaning in such a case, the normal pH as well as the washing time pH will be around pH 7; the difference will be approximately zero, so the recovery time check will not work normally.

This function is available either for ORP measurement only.

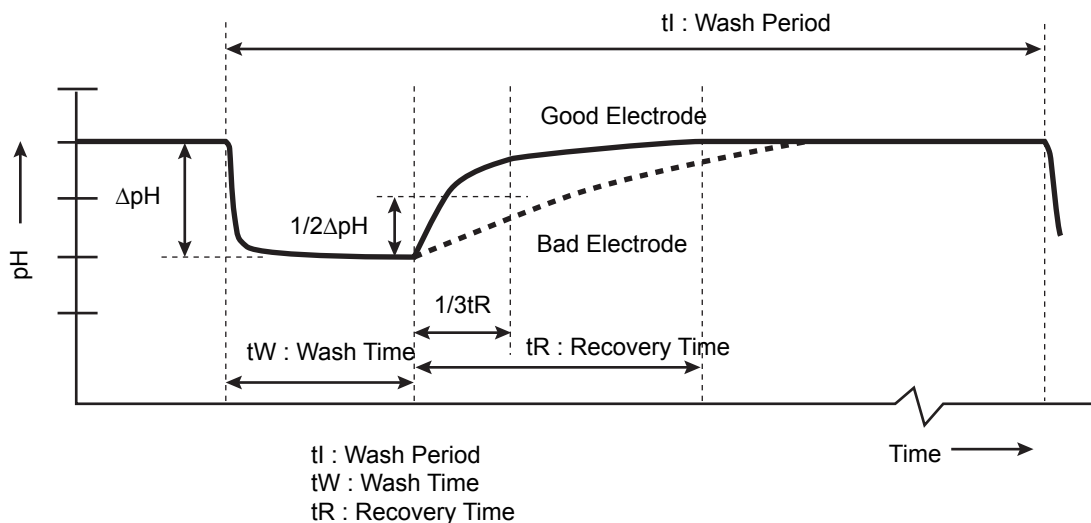

Figure 4.6

### 4.6.6 Factory setup

For "Factory setup," there is no item to be set by the user.

#### NOTE

This menu is for service engineers only. This section is protected by a password. Attempting to change data in the factory adjustment menu without the proper instructions and equipment could result in corruption of the instrument setup and damage the performance of the unit.

### 4.7 Display setup

This screen is used to make various settings relating to screen display.

#### NOTE

Settable items differ depending on settings in "Sensor setup" and "Measurement setup."

## 4.7.1 Main display (Dual display, Individual display)

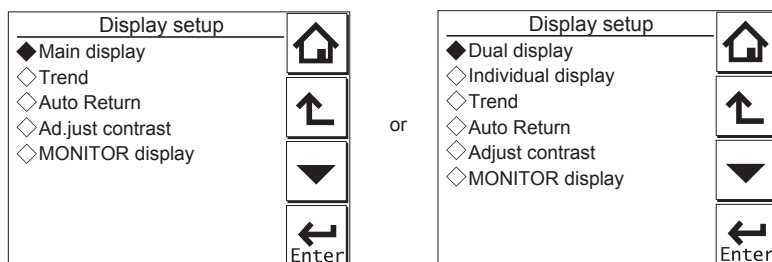

Figure 4.7 Display setup screens for a single module (left) and two modules (right)

### ● Main display

When one module is installed on the instrument, only the Main display is available.

Three measurement values can be set to display on the Main display as a primary value (1st line), a second value (2nd line) and a third value (3rd line) respectively.

On the “Additional text”, a text of up to 12 alphanumeric characters can be assigned to each measurement value.

Additional texts are displayed on the Main display, and are useful for identifying measurements. In some cases, not all 12 characters can be displayed due to the letters; check the texts displayed on the Main display after setting. If a part of the text is missing, adjust the number of characters.

### ● Dual display

This screen is used to set items to be displayed in the top part (1st row) and bottom part (2nd row) of the Home display. These settings are available when two sensors are installed in the instrument.

When the “Empty” is selected for the 2nd row, the Home display can not be displayed.

### ● Individual display

When two modules are installed on the instrument, display items on the Main display for each module can be set on these settings.

On the “PH1 display” or “PH2 display” screen, three measurement values can be set to display on each Main display as a primary value (1st line), a second value (2nd line) and a third value (3rd line) respectively.

On the “Additional text”, a text of up to 12 alphanumeric characters can be assigned to each measurement value.

Additional texts are displayed on the Main display, and are useful for identifying measurements. In some cases, not all 12 characters can be displayed due to the letters; check the texts displayed on the Main display after setting. If a part of the text is missing, adjust the number of characters.

## 4.7.2 Trend

This screen is used to make settings for the Trend Graph Screen.

Set the process parameters to be displayed for each trend. They can be set for the 1st to 3rd trends. When all three process parameters are set “Empty”, there is no trend display (no trend button).

- **X-axis: Timing**

Select the X-axis timing’s time span on the trend graph display from a list.

- **Y-axis: Limits**

Set the Y-axis high and low limits on the trend graph display on a Trend screen basis.

### NOTE

---

Updating the trend display setup resets the current trend graph and starts a new one.

---

## 4.7.3 Auto Return

When no operation is performed for the time set in “Auto Return”, the display returns to the Monitor display (or to the Main display when the MONITOR display is disabled) and the analyzer returns to a normal measuring mode. (When the Trend display is selected, the Auto Return doesn’t work.)

Select the time from among Disable, 10 min, and 60 min. When the Auto Return function is not used, select “Disable.”

### NOTE

---

A default is “10 min”. When maintenance like a calibration that may take much time is performed, “60 min” or “Disable” is recommended to be selected.

---

## 4.7.4 Adjust contrast

The LCD screen contrast can be adjusted.

Pressing the ▲ ▼ keys adjusts the contrast in 11 levels from +5 to –5 (including the default value of “0”).

## 4.7.5 MONITOR display

Select “Enable” so that the Monitor display becomes available. A default is “Enable”.

During Hold/Wash condition and a warning/fault condition, the Main display or the Home display is displayed to indicate the condition.



## 4.8 Calculated data setup

On this setup, parameters can be set for calculated data.

When two modules are installed on the instrument, the calculated data can be set for pH values or ORP values measured by two sensors.

Select “Differential” or “Average” on the Calculated data setup screen.

Differential: A difference between measurement values measured by a sensor 1 and sensor 2 is an output as a calculated result.



(Diff)  $(\text{value of the sensor 1}) - (\text{value of the sensor 2})$

Average: The average of measurement values measured by a sensor 1 and sensor 2 is an output as a calculated result.

(Ave)  $(\text{value of the sensor 1} + \text{value of the sensor 2}) / 2$

To display the calculated result, select “Calculated” on the Dual display screen (Section 4.7.1). (The setting on the “Individual display” has no effect.)

While displaying a calculated data, measurement value of the sensor 1 or sensor 2 can be

checked on the each sensor’s display with pressing  or  at the lower right on the Main display.

Pressing  returns the display to the original calculated data display.

A calculated data can be set as a process parameter on the “mA (Output)” setup screen (Section 4.3).

# 5. CALIBRATION OF pH/ORP

Before pH measurement, calibrate the pH sensor with the standard solution.

Before ORP measurement, check the electrode as a part of regular maintenance.

## NOTE

A default is “10 min” for “Auto Return”. When maintenance like a calibration that may take much time is performed, “60 min” or “Disable” is recommended to be selected. (Refer to the section 4.7.3.)

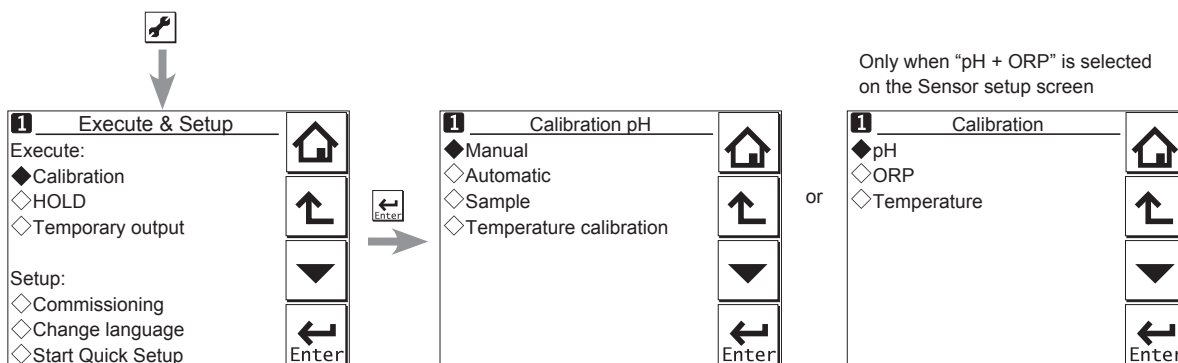



Figure 5.1 Calibration

The calibration items include pH, ORP, rH, and Temperature.

The item to be calibrated is determined according to the settings made in the Sensor setup and Measurement setup in Commissioning.

Press  to select Execute: Calibration, choose the item to be calibrated, configure the calibration settings, then perform calibration.

## NOTE

Note the following when performing calibration with buffer solutions.

1. Before starting a calibration, make sure the electrode system is properly cleaned and the electrodes are fully functional. They must then be rinsed with clean water to avoid contamination of the calibration solution(s).
2. Always use fresh buffer solution to avoid the risk of introducing errors from contaminated or old solutions. Buffers supplied as liquids have a limited shelf life, especially alkaline buffers, which absorb CO<sub>2</sub> from the air.
3. Yokogawa strongly recommends NIST/DIN 19266 buffer standards for the best accuracy and buffer capacity. Commercially adjusted buffers (e.g., pH 7.00, 9.00 or 10.00) are a compromise as a standard, and are often supplied without a temperature dependency curve. Their stability will never be as good as NIST (JIS equivalent) solutions.

Always ensure that the sensors are properly conditioned, clean and filled with the correct electrolyte solution (if appropriate) before starting a calibration. Refer to the sensor instructions for details.

## 5.1 pH calibration

There are the Manual, Automatic, and Sample modes of pH calibration.

### 5.1.1 Manual calibration

The unit is adjusted to match the value of the buffer standards or a process solution with a known pH value (buffer solution).

The user determines the pH value, temperature influence, and stability.

Select the calibration type from among [zero/slope], [zero/slope/ITP(3point)], and [zero/slope1,2 (3point)].

Calibration is performed stepwise; follow the prompts displayed on the screen.

A stability check is conducted at each measurement point. Proceed to the next step only after the reading has stabilized.

At calibration, we advise leaving the sensors for three to five minutes in the buffer solution before proceeding to the next step even when the reading has stabilized. This will give reliable and accurate calibration results.

#### NOTE

When a sensor or an electrode is exchanged or replaced, sensor wellness data should be reset.

When a sensor is replaced, the replacement can be recorded manually into a logbook. (Refer to the figure 3.9.)

#### ● zero/slope

This calibration type is one-point or two-point calibration.

One-point calibration performs the zero adjustment only. Two-point calibration performs the zero and slope adjustments.

#### ● zero/slope/ITP(3point)

This calibration type is ITP-type three-point calibration.

If ITP does not have pH 7, three-point calibration is performed to obtain the zero (asymmetry), slope (sensitivity), and ITP (isothermal point) for calibration.

#### Limitations

- Three different buffer solutions whose difference in pH value between buffer solutions is 1 pH or more should be used.  
(1st buffer < 2nd buffer < 3rd buffer or 1st buffer > 2nd buffer > 3rd buffer)
- The 2nd buffer solution should be pH  $7 \pm 2$ .
- The temperature difference between the 2nd and 3rd buffer solutions should be 5°C or less. The temperatures of the 2nd and 3rd buffer solutions should be at least 20°C higher or lower than the temperature of the 1st buffer solution.
- To calculate the pH value of the 3rd buffer solution ( $pH_{3cal}$ ), insert the pH and temperature values of the 1st and 2nd buffer solutions and the temperature value of the 3rd buffer solution into the following equation.

$$\text{pH}_{3\text{cal}} = \text{ITP} - \frac{\left( \frac{t_3 - t_1}{t_2 - t_1} (273.15 + t_2)(\text{ITP} - \text{pH}_2) + \left(1 - \frac{t_3 - t_1}{t_2 - t_1}\right) \times (273.15 + t_1)(\text{ITP} - \text{pH}_1) \right)}{(273.15 + t_3)}$$

$\text{pH}_n$ : pH value of n-th buffer solution

$T_n$ : Temperature of n-th buffer solution (°C)

ITP: ITP value displayed in calibration settings (see section 4.2.4)  
Assign 7.00 as the ITP value when a specific value is not available or for the first calibration of a sensor.

Do not use the 3rd solution whose pH value is within  $\text{pH}_{3\text{cal}} \pm 1$ .

### ● zero/slope1,2(3point)

This calibration type is the line-segment type three-point calibration.

If the relation between electromotive force and pH is not in proportion for a wide range, divide the relevant range into two sections and obtain the zero (asymmetry) and slope (sensitivity) in each section to perform calibration.

#### Limitations

- Three different buffer solutions whose difference in pH value between buffer solutions is 1 pH or more should be used.  
(1st buffer < 2nd buffer < 3rd buffer or 1st buffer > 2nd buffer > 3rd buffer)
- The temperature difference between the 1st and 2nd buffer solutions should be 20°C or less.
- The temperature difference between the 2nd and 3rd buffer solutions should be 20°C or less.

## 5.1.2 Automatic calibration

Calibration can easily be performed by following the calibration menus.

Pre-select the buffer solution to be used from among NIST/DIN 19266, DIN 19267, US, and User defined buffer in Commissioning → Measurement setup → Calibration settings → pH settings → Buffers (select set). See also Appendix table 1.

If you select User defined buffer, calibration is performed based on the conditions registered in buffer tables 1 to 3. Use of the proper buffer table allows the system to perform reliable calibration.

In the same way as manual pH calibration, select the calibration type from among [zero/slope], [zero/slope/ITP(3point)], and [zero/slope1,2(3point)].

Calibration is performed stepwise; follow the prompts displayed on the screen.

A stability check is conducted at each measurement point. Proceed to the next step only after the reading has stabilized.

### NOTE

When a sensor or an electrode is exchanged or replaced, sensor wellness data should be reset.

When a sensor is replaced, the replacement can be recorded manually into a logbook. (Refer to the figure 3.9.)

● **zero/slope**

Select the solution that works with the “buffer solution” selected in calibration settings and perform calibration by following the prompts on the screen.

● **zero/slope/ITP(3point)**

Calibration is performed in the sequence of the sequence selection menu (Table 5.1) of the solution that works with the “buffer solution” selected in calibration settings. Perform calibration by following the prompts on the screen.

**Limitations**

- Three different buffer solutions whose difference in pH value between buffer solutions is 1 pH or more should be used.  
(1st buffer < 2nd buffer < 3rd buffer or 1st buffer > 2nd buffer > 3rd buffer)
- The 2nd buffer solution in the buffer table in the Free programmable screen should be pH 7 ± 2 (at 25°C).
- Either of the following conditions should be met.
  - The temperature difference between the 1st and 2nd buffer solutions should be 5°C or less. The temperature of the 1st and 2nd buffer solutions is at least 20°C higher or lower than the temperature of the 3rd buffer solution.
  - The temperature difference between the 2nd and 3rd buffer solutions should be 5°C or less. The temperature of the 2nd and 3rd buffer solutions is at least 20°C higher or lower than the temperature of the 1st buffer solution.

● **zero/slope1,2(3point)**

Calibration is performed in the sequence of the sequence selection menu (Table 5.1) of the solution that works with the “buffer solution” selected in calibration settings. Perform calibration by following the prompts on the screen.

**Limitations**

- Three different buffer solutions whose difference in pH value between buffer solutions is 1 pH or more should be used.  
(1st buffer < 2nd buffer < 3rd buffer or 1st buffer > 2nd buffer > 3rd buffer)
- The temperature difference between the 1st and 2nd buffer solutions should be 20°C or less.
- The temperature difference between the 2nd and 3rd buffer solutions should be 20°C or less.

**Table 5.1 Selection of Buffer Solutions in Three-point Calibration**

Buffer settings	Buffer sequence selection menus
NIST/DIN 19266	PH1.7→PH6.9→PH9.2
	PH4.0→PH6.9→PH9.2
	PH9.2→PH6.9→PH1.7
	PH9.2→PH6.9→PH4.0
DIN 19267	PH4.7→PH6.8→PH9.2
	PH9.2→PH6.8→PH4.7
US	PH4.0→PH7.0→PH10.0
	PH10.0→PH7.0→PH4.0
User defined buffer	table1→table2→table3
	able3→table2→table1

### 5.1.3 Sample calibration

A sample calibration is a single-point calibration for only the zero (asymmetric). It adjusts the recorded reading to a collected sample value. Press [Take Sample] to record a collected sample value in memory. Re-enter the Sample Cal. screen and press [Start calibration] to perform a sample calibration. This updates the recorded data.

#### NOTE

---

When a sensor or an electrode is exchanged or replaced, sensor wellness data should be reset. When a sensor is replaced, the replacement can be recorded manually into a logbook. (Refer to the figure 3.9.)

---

5

## 5.2 Temperature calibration

For the most accurate measurements, it is important to have a precise temperature measurement. Measure the temperature with a high-precision thermometer and adjust the sensor reading accordingly. For best accuracy, this should be done as near to the normal operating temperature as possible.

## 5.3 ORP calibration (rH calibration)

The calibration modes for ORP or rH are “Manual” and “Sample”. No automatic calibration feature is available in an ORP or rH calibration.

Calibration is performed stepwise. Follow the prompts displayed on the screen.

A stability check is made at each measurement point. Proceed to the next step only after the reading has stabilized.

#### NOTE

---

When a sensor or an electrode is exchanged or replaced, sensor wellness data should be reset. When a sensor is replaced, the replacement can be recorded manually into a logbook. (Refer to the figure 3.9.)

---

PH

## 5.4 HOLD

The FLXA202/FLXA21 has a function to hold the mA output at a preset value (default: “Last”). Use this menu to hold the output.

For the settings, see “■ Configure Hold” on page 4-11.

During commissioning or quick setup, the output is automatically held.

Setting “Hold during Calibration/Wash” to “Disabled” deactivates the hold function during calibration or washing.

Press  to select Execute: HOLD and then choose Manual Hold ON or Manual Hold OFF. This allows you to set up manual hold.

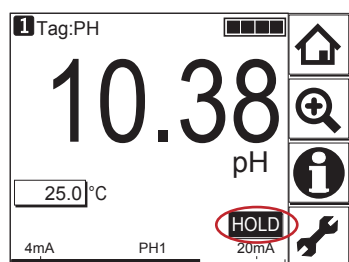





Figure 5.2 Example of the display with the manual hold enabled

To cancel manual hold, press the lit  section on the Main display.

## 5.5 Temporary output

If measurement cannot be made due to replacement of one of the sensors, assignment of mA output can be temporarily changed from the currently setup sensor to the other sensor. This feature is enabled only when two sensors are connected and the process parameters including pH have been configured.

Press  to select Execute: Temporary output and then choose the process parameter to be assigned on the Temporary output screen.

When process parameter assignment has been modified, the  indication at the upper left of the screen changes to .

The feature is disabled the moment the screen returns to the Main display, and the setting (process parameter in mA output setting) returns to the original condition.

# 6. OPERATION OF SC (Conductivity)

This chapter describes the screen operations of SC, the object to be measured. Further details of screen operations can also be found in section 1.2.

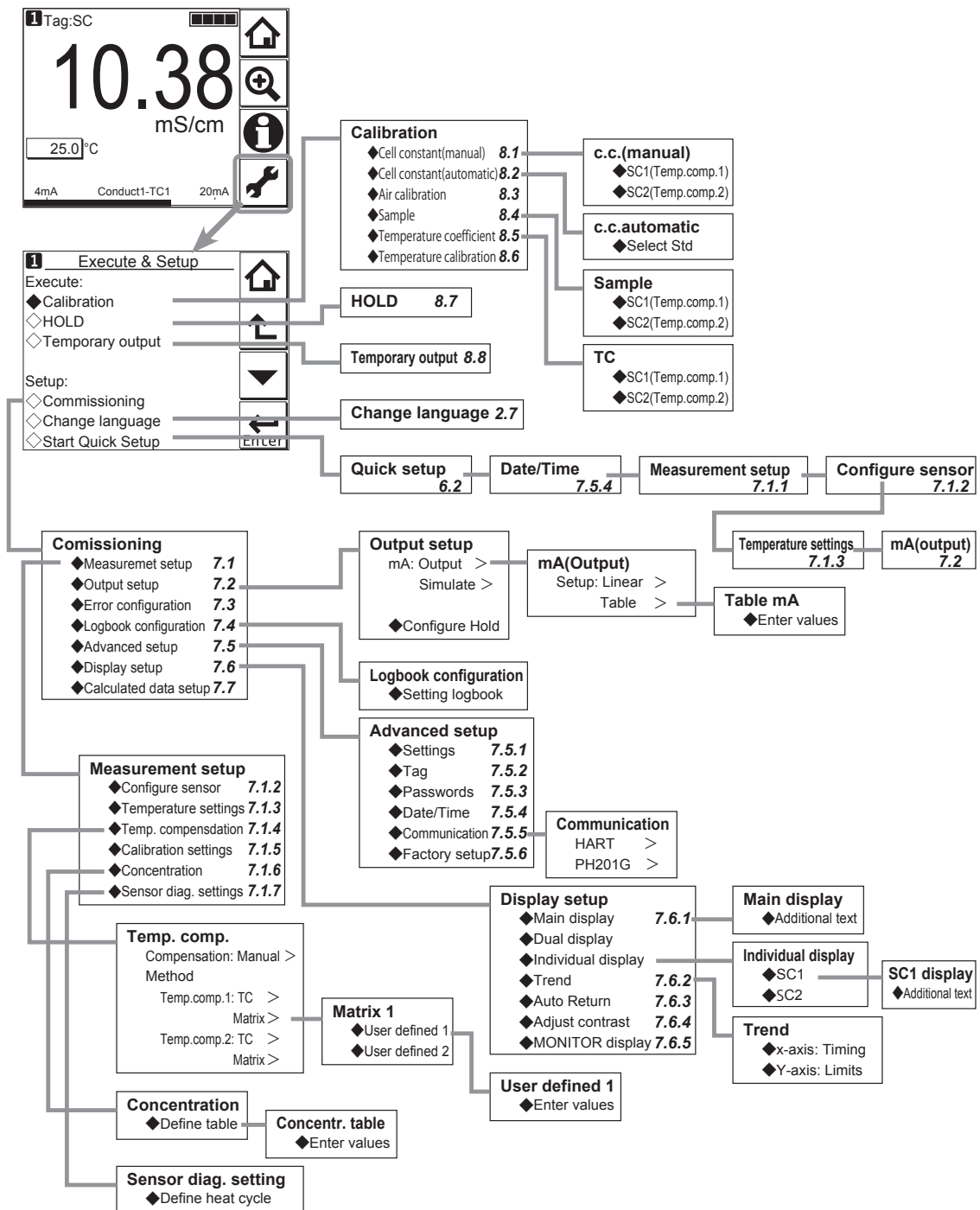

Figure 6.1 Menu structure of SC (the number after the item refers to the relevant section)

## 6.1 Change language

The screen is set to display English at factory shipment; if you wish to use the FLXA202/FLXA21 in another language, first select a language as described in section 2.7.

6

SC



---

## 6.2 Quick setup

The Quick setup screen is used to set up the basic items you want to set up first, such as the date/time and sensor settings. The detailed settings are described in chapter 8, Commissioning.

You may leave the Quick setup now and return to it later; however, it is recommended to perform the quick setup first.

Each time the FLXA202/FLXA21 is started up, this screen is displayed. If it is not necessary to

change the setup, press No or .

### NOTE

---

When no operation is performed for 10 minutes or 60 minutes (depending on the setting of “Auto Return”), the display except Trend display automatically changes to the Monitor display (or to the Main display or the Home display when the MONITOR display is disabled).

---

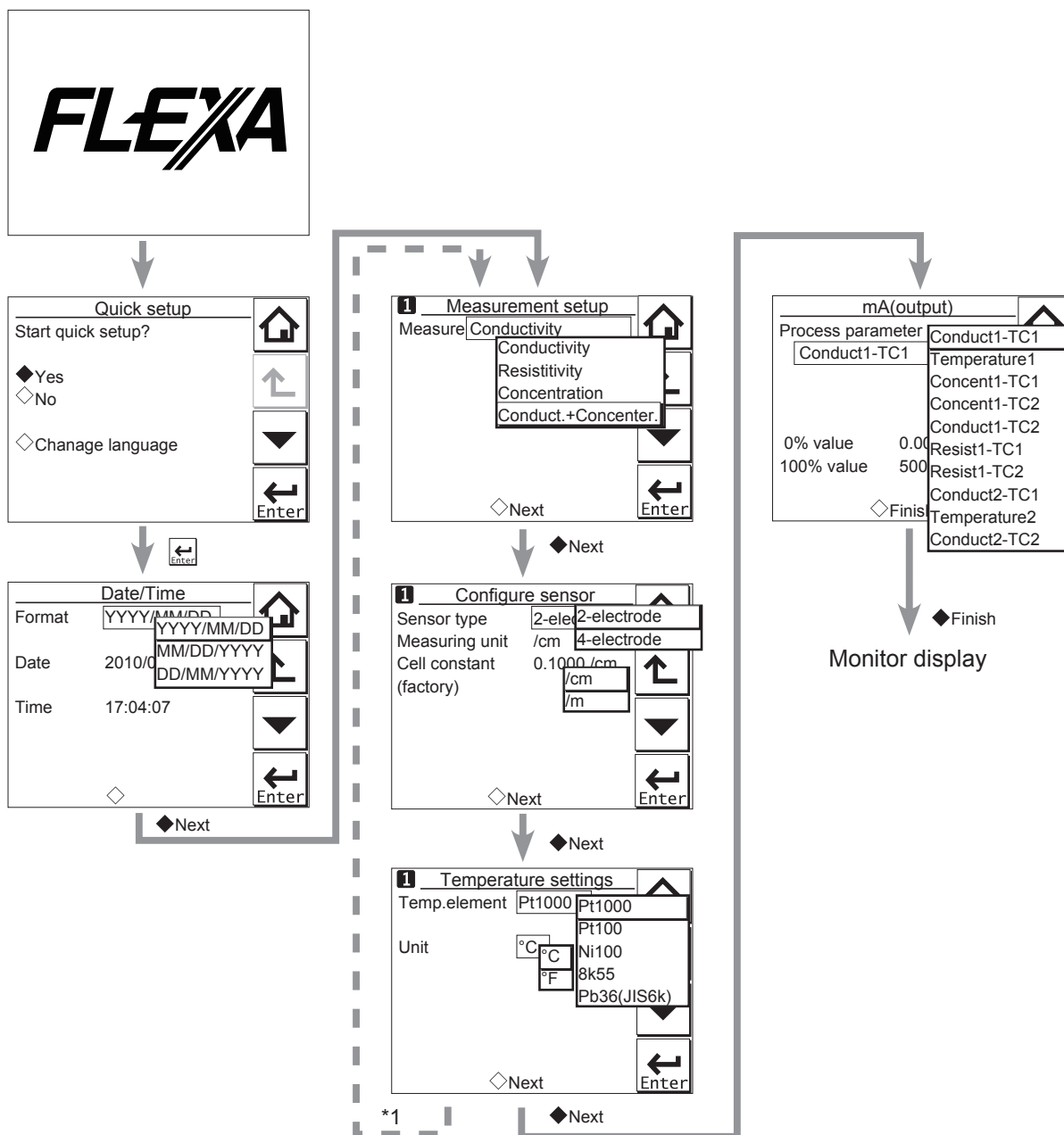

\*1: If two sensors are connected, the second sensor can also be set up.

Figure 6.2 Quick setup

### ■ Date/Time

The date display format can be selected from among the three types.

Enter the date or time of day by using the numerical keys.

For details, see section 7.5.4.

### ■ Measurement setup

Select a suitable measurement parameter from among those displayed and set it up.

Measurement parameter setup can be made only when “SC” is selected on the Sensor setup screen.

For details, see section 7.1.1.

6

SC

### ■ Configure sensor

From among the sensor types displayed on this screen, select an appropriate electrode for the sensor used. The measurement units can also be selected from among “/cm” and “/m”.

The cell constant (factory default) is determined by factory calibration made during manufacturing.

The cell constant is indicated on the sensor. If a new sensor is used, the cell constant indicated here should be changed. When this value is changed, the real cell constant will also be changed.

For details, see section 7.1.2.

### ■ Temperature settings

Select a suitable temperature element from among those displayed and set it up.

Celsius (°C) or Fahrenheit (°F) temperature scale can be selected.

For details, see section 7.1.3.

### ■ mA (output)

Select an appropriate process parameter from among those displayed and set it. The mA output has been set to 0 – 500  $\mu$ S/cm or 0 to 20  $\Omega$  cm at factory shipment. If a high resolution is required in a consistent measurement process, set this parameter to a value suitable for the process.

For details, see section 7.2.

## 6.3 Home display, Main display and Monitor display

Pressing  changes the screen to the Main display shown in Figure 6.3 (or the Home display shown in Figure 6.4).

If two sensors are connected, pressing  on the Main display changes the display to the Home display shown in Figure 6.4.

If only one sensor is connected,  is grayed out and disabled on the Main display.

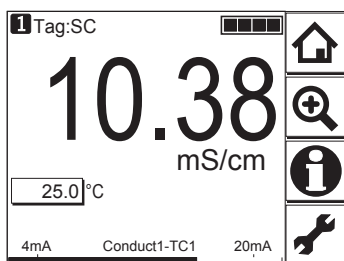

Figure 6.3 Example of main display

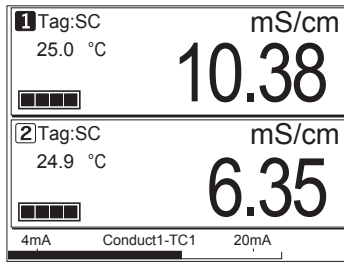

Figure 6.4 Example of home display

On the Home display, pressing  of the 1st sensor (top) or 2nd sensor (bottom) causes the display of the selected sensor to appear on the Main display.

On the Main display, pressing  of the 2nd or 3rd display item causes the 1st display item to be replaced by the selected item.

**NOTE**

Measured values to be displayed in the 1st to 3rd display items depend on the user definition (see section 7.6.1). In the default condition, the 1st display item is conductivity, the 2nd display item is temperature, and the 3rd display item is empty.

When the MONITOR display is enabled (see section 7.6.5), pressing the 1st display item on the home display or the main display changes the display to the Monitor display with the enlarged font of the measured value.

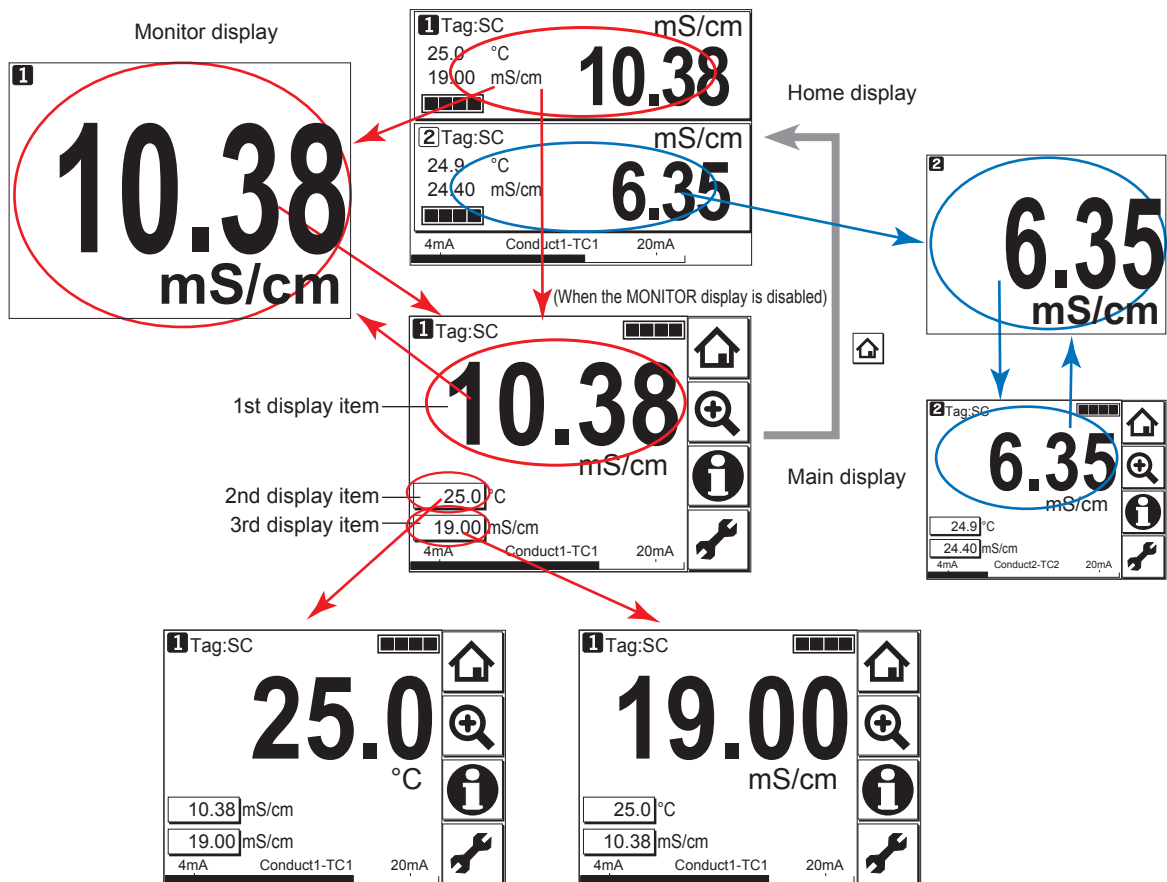

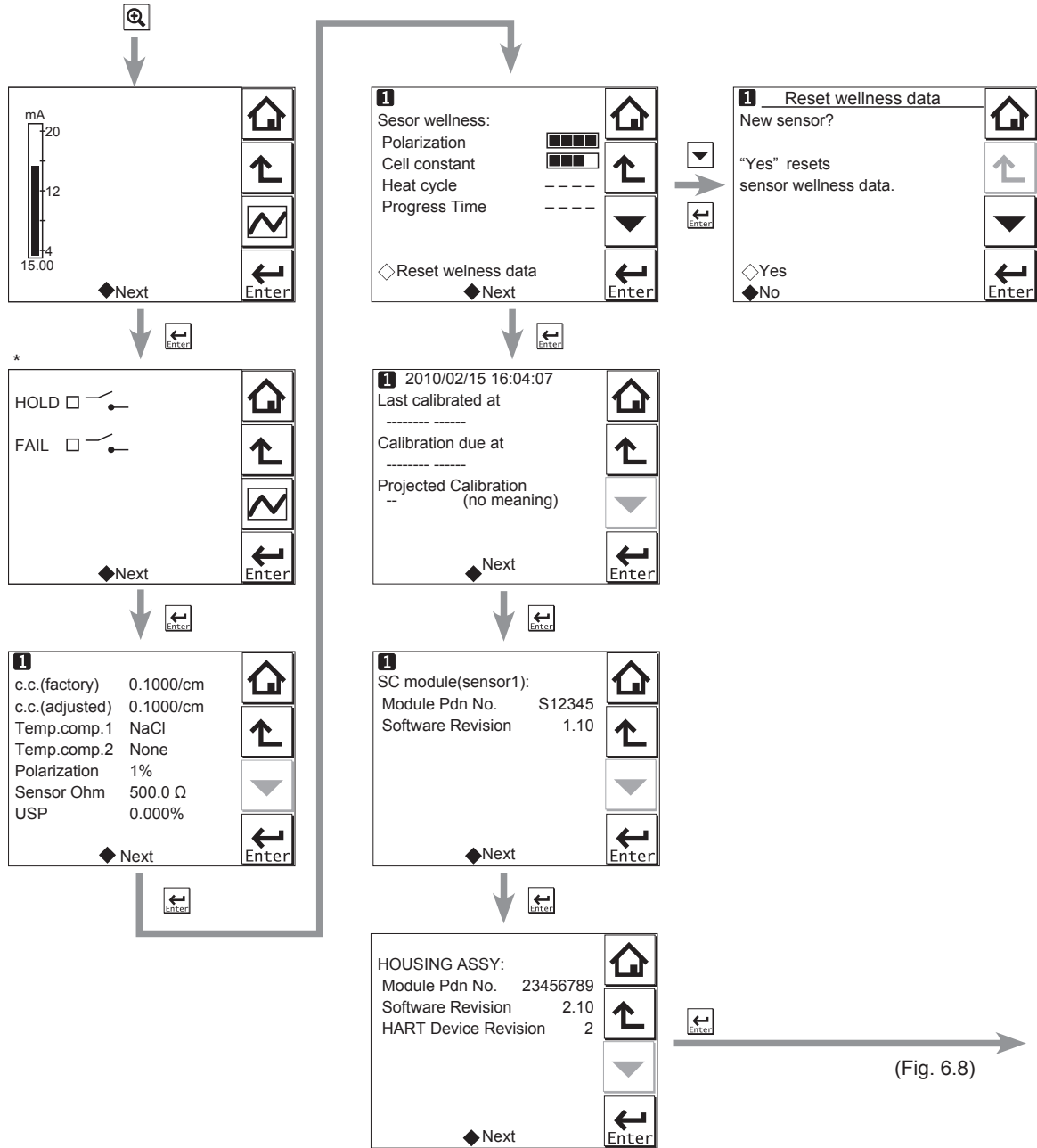

Figure 6.5 Change Display

# 6.4 Zooming in on details

Pressing  on the Main display allows you to check detailed instrument information (instrument information such as setup, sensor diagnosis, calibration, and module productions number) through a transition of screens as shown in Figure 6.6.

In case of trouble, when you contact your nearest Yokogawa service center, please inform us of the module and FLXA202/FLXA21 software revision displayed on the Detail screen and other display information as well as the module productions number indicated on the nameplate attached to the instrument.



\*: This screen is displayed only if the PH201G distributor is used and "PH201G" is selected in communication setup.

**Figure 6.6** Detail display

## ■ Current output mA

= current output in mA. The range and function of this mA output can be set in Commissioning → Output setup → mA.

For details, see section 7.2.

## ■ Contact status

This screen is displayed only if the PH201G distributor is used and "PH201G" is selected in communication setup.

## ■ c.c. (factory)

This parameter displays the cell constant (factory setting).

The cell constant (factory setting) is determined by factory calibration made during sensor manufacturing. This value can be set in Commissioning → Measurement setup → Sensor setup.

The cell constant is indicated on the sensor or cable label.

## ■ c.c. (adjusted)

This parameter displays the cell constant (adjusted).

The cell constant (adjusted) is a cell constant that has been calibrated and is set by calibration action.

When the system's cell constant is adjusted on-line by calibration using a process solution or buffer solution, a new cell constant is logged here. The difference between this value and the default value set at factory shipment will not be large. If there is a large difference between them, check whether the sensor is broken or contaminated.

## ■ Temp. comp. 1

This parameter shows the temperature compensation method for 1st measurement. The setting is made in Commissioning → Measurement setup → Temp. comp.

## ■ Temp. comp. 2

This parameter shows the temperature compensation method for 2nd measurement. The setting is made in Commissioning → Measurement setup → Temp. comp.

2nd measurement does not imply that two measurements can be made individually, but it means that two types of compensation methods can be configured, which enables two phases to be monitored accurately in the same process. An example is monitoring the switching between process and washing solutions.

## ■ Polarization

This parameter indicates the degree of polarization of the sensor. It is an index of the degree of sensor contamination (adherents). The greater the value, the more the polarization has progressed. If the value is high, maintenance should be performed on the sensor as soon as possible.

## ■ Sensor Ohm

This parameter represents the non-compensated resistance of the sensor.

## ■ USP

USP stands for United States Pharmacopeia and indicates the margin of safety for the water for injection (WFI) conductivity at each temperature as a percentage.

## ■ Sensor wellness

At the Sensor wellness window, the soundness of a module is displayed. A larger number of ■ in each gauge indicates that the parameter concerned is sound. A gauge is indicated for only those parameters whose sensor wellness setting is “enabled,” while a bar (---) is displayed if the sensor wellness setting is “disabled.”

Sensor wellness setup can be made in Commissioning → Measurement setup → Sensor diag. settings. For details, see section 7.1.7.

The “Reset wellness data” button can reset wellness data.

When a sensor is exchanged or replaced, sensor wellness data should be reset.

### NOTE

When a sensor is replaced, the replacement can be recorded manually into a logbook. (Refer to the figure 6.8.)

## ■ Last calibrated

= date on which the last sensor calibration was performed. The displayed value of the Zero is the result of this calibration. The displayed value of Slope was calibrated on this date only if the last calibration was a 2-point calibration.

## ■ Calibration due

= the date when the calibration must be done next according to the settings of the calibration interval. The calibration intervals are set in Commissioning → Measurement setup → Calibration settings → Limits and timing.

## ■ Projected replacement

The projected maintenance function predicts the date when the sensor unit will need cleaning or recalibrating for maintaining measurement accuracy. This function checks the cleanliness of the sensor by monitoring the polarization of the electrodes every 24 hours and the cell constant after the calibration. Clean the sensor before the predicted date.

The function predicts the following two dates:

- When the cell constant crosses the upper or lower limits
- When the value of the polarization of the electrodes reaches the alarm point (15% or more).

The function displays the earlier date with the status (the status is displayed in parentheses).

As shown in Figure 6.7, the date is predicted based on the intersection point of the upper or lower limits and the extrapolated line of the values obtained by the least squares method.

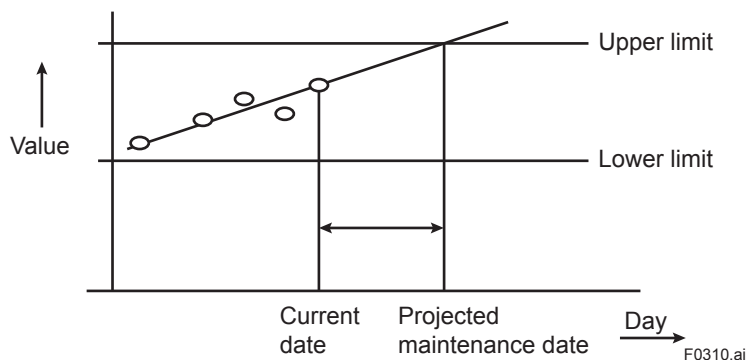

Figure 6.7

The status shows the certainty of the projected maintenance date in terms of the correlation coefficient R. Tables 6.1 and 6.2 show respective display patterns.

**Table 6.1 Display pattern of the projected maintenance date**

<b>Projected date</b>	--	0-1 month	1-3 months	3-6 months	6-12 months	Over 1 year
-----------------------	----	-----------	------------	------------	-------------	-------------

--: cannot be predictable due to insufficient data

**Table 6.2 Display pattern of the status**

<b>Status</b>	(-----) (R < 0.50)	(Poor) (0.50 ≤ R < 0.70)	(Reasonable) (0.70 ≤ R < 0.85)	(Excellent) (0.85 ≤ R < 1.00)
---------------	-----------------------	-----------------------------	-----------------------------------	----------------------------------

### ■ SC module (sensor)

With this screen, you can check the module productions number and software revision of the installed module.

### ■ HOUSING ASSY

With this screen, you can check the module productions number, software revision, and HART device revision of the housing assembly.

### ■ Read logbook

The FLXA202/FLXA21 has two types of logbook per sensor to store history information on events, such as changed settings and calibrations.

By selecting one of the logbooks that you wish to check, you can retrieve and check this information. Storage of history information on each event in a logbook or which logbook to use for storage can be set up on the Configure logbook screen. For details, see section 7.4.

History information on events are automatically stored on the preset conditions.

In addition to this storing, following three messages can be manually stored in the logbook;

"Sensor washed by hand", "Module replaced", "Sensor replaced"

To store these messages, press  and select one of three messages from the Item on the Memorandum screen. Its event date/time will be the time when a message is selected and entered.

When a password for Commissioning is set on the passwords' setup, pressing  requires entering the password. (Refer to the section 7.5.3.)



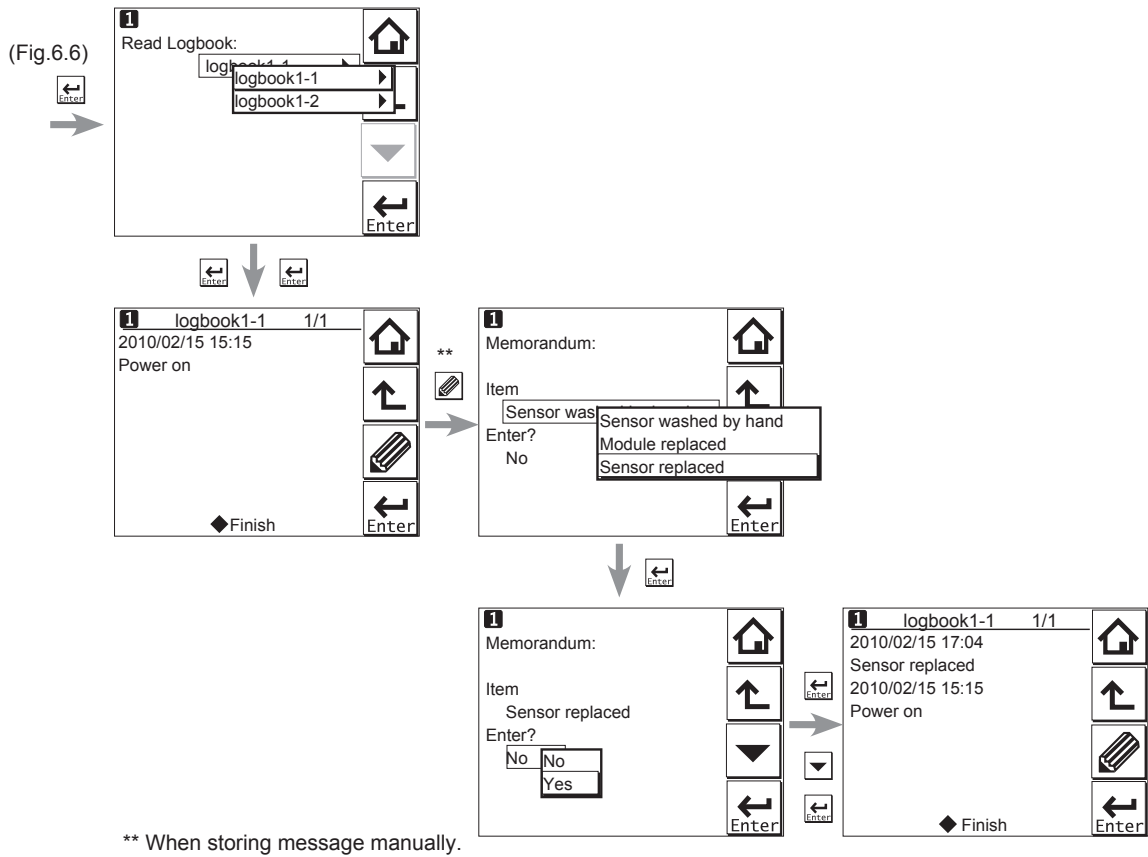



Figure 6.8 Detail display (continued)

## 6.5 Trend graphics

Pressing  on the Zoom display changes the display to a graphical mode in which the average measured value is shown on a time scale. The “Live” value is also digitally displayed in a text box. The time scale (X-axis) and the primary value scale (Y-axis) are set in the “DISPLAY SETUP” menu (Section 7.7.2).

The screen displays the trend of up to 41 averages of the measurement for each time interval. The FLXA202/FLXA21 samples the measurements every second. The trending graphic also shows the maximum and minimum measured values in that interval.

For example, if the time scale is set to 4 hours, then the trend is shown for 4 hours prior to the actual measurement. Each point on the trend line represents the average over  $4 \times 60 \times 60 / 41 = 351$  measurements (seconds).

### NOTE

Updating the trend screen setup resets the current trend graph and starts a new one.

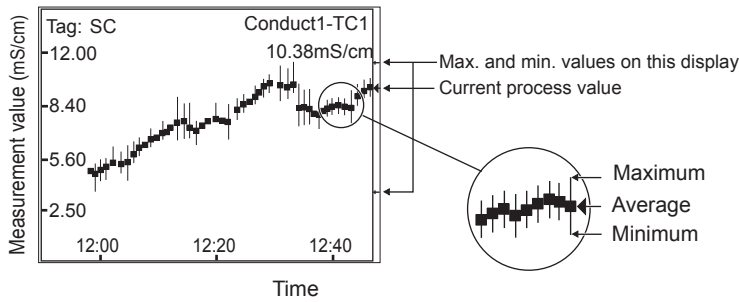

Figure 6.9 Trend screen

The 1st display item data on the Main display is shown as a graph. Touching any point on the display changes the display to the 2nd display item data (and to the 3rd display item data if set) and then returns to the Main display.

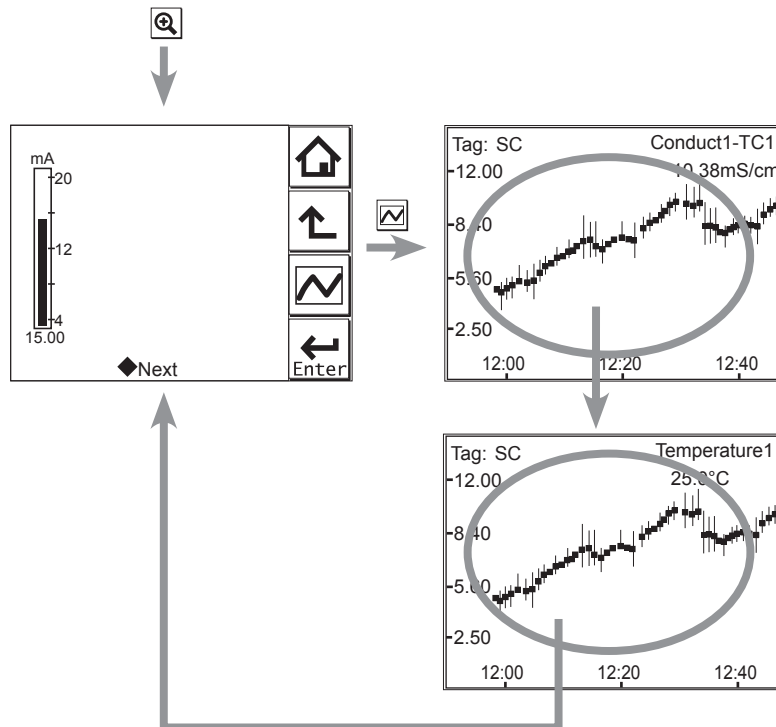

Figure 6.10 Trend graphics

## 6.6 Instrument status screen

In the  field of the Main display, the  (Warning) or  (Fault) sign appears according to the instrument status. Upon pressing the displayed button, detailed information of the relevant status appears.

See “ Information button” on page 1-10.

## 6.7 Calibration and Commissioning

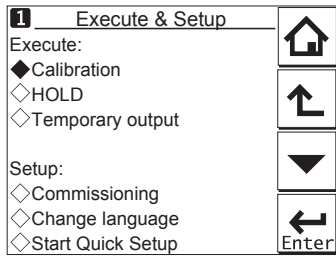

Allows you to calibrate and configure the instrument. These operations can be protected with a password.

For details on the password, refer to section 7.5.3.



**Figure 6.11**      **Execute & Setup**

Pressing  changes the display to the Execute & Setup screen.

Browse through the menu items by pressing  until you find the desired menu and then press  to enter that menu. It is also possible to enter a desired menu by pressing the  $\diamond$  symbol beside the menu item.

For calibration (HOLD, Temporary output), read chapter 8, and for commissioning, read chapter 7.

# 7. COMMISSIONING OF SC (Conductivity)

This chapter describes how to check and change settings from the Commissioning screen. When you move to the Commissioning screen, the output is held.

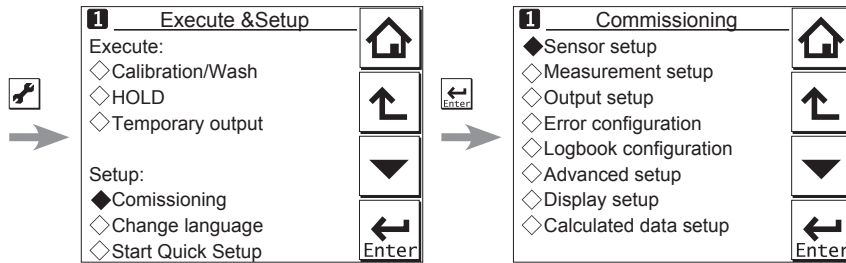

Figure 7.1 Example of the commissioning screen (for two modules)

Operations in Commissioning can be password-protected. If you set up a password, always take a note of it. For details on setting a password, see section 7.5.3.

Figure 6.1 shows the commissioning procedure. Before changing any parameters, read the relevant sections in this document and understand how the change of parameters affects the performance of this instrument. If you set a wrong value, return it to the default setting or value and then set it again.

On the first startup, the parameters are all default values configured at the factory. Check the parameters in Table 7.1 and change any of them if necessary depending on the sensors to be connected and the purpose of use.

Set "Measurement" and "Sensor type" first. Some measurement parameters and relevant options change accordingly. The underlined parameters in Table 7.1 are used for the quick setup.

The default values and setting ranges are listed in the "User setting table of SC" in the attached CD-ROM.

After confirming that the instrument operates normally with the parameters, print out the "User setting table of SC" and write down these parameters in the column of User Settings.

All user parameters can also be saved in the instrument.

Select Commissioning → Advanced setup → Settings → Save user settings (see Section 7.5.1).

**Table 7.1 Menu Structure and Default Values in “Commissioning”**

Parameter		Ref. sect.			
Measurement setup	<u>Measurement</u>	7.1.1			
	Configure sensor	<u>Sensor type</u>	7.1.2		
		<u>Measuring unit</u>			
		<u>Cell constant (factory)</u>			
	Temperature settings	<u>Temp. element</u>	7.1.3		
	Temp. compensation	Compensation	7.1.4		
		Reference temp.			
		Method			
	Calibration settings	Limits:	Air adjust	7.1.5	
			c.c.		
Timing:		Step Range			
		Stabilization time			
Concentration	Additional table	7.1.6			
	Unit for table				
Sensor diag. settings	Process time:	7.1.7			
	Heat cycle:				
	Define heat cycle				
Output setup	mA	Output	<u>Process parameter</u>	7.2	
			Setup		
			Linear		<u>0 % value</u>
					<u>100 % value</u>
			Table		
			Burn		
			Damping time		
			Simulate		Simulation perc.
Configure Hold					
Error configuration		7.3			
Logbook configuration		7.4			
Advanced setup	Settings	7.5.1			
	Tag	7.5.2			
	Passwords	7.5.3			
	Date/Time	7.5.4			
	Communication	HART	7.5.5		
		PH201G			
Factory setup	7.5.6				
Display setup	Main display (Dual display, Individual display)	7.6.1			
	Trend	7.6.2			
	Auto Return	7.6.3			
	Adjust contrast	7.6.4			
	MONITOR display	7.6.5			
Calculated data setup	Function	7.7			

**NOTE**

All the parameters for the quick setup (underlined ones in Table 7.1) are crucial for measurement. If you change any of them, other parameters may be initialized. For the parameters that may initialize other values, see Appendix 2.

## 7.1 Measurement setup

This section describes how to set up various parameters relating to measurements.

Measurements are performed based on the measurement parameter setup.

### 7.1.1 Measurement

Select a measurement parameter from Conductivity, Resistivity, Concentration, and Conduct. + Concentr. The setting of the measurement parameter changes the menu structure in Error configuration, Display setup, etc. accordingly.

### 7.1.2 Configure sensor

This section describes how to configure the sensor to be connected.

- **Sensor type**

Choose the sensor type from “2-electrode” and “4-electrode.”

Two-electrode sensors are usually used for conductivity and/or resistivity measurements.

However, polarization of the electrodes may occur at high conductivity ranges, which may cause an error in conductivity measurement. To avoid this, use 4-electrode sensors.

- **Measuring unit**

Either /cm or /m can be chosen here.

The process values will be expressed in S/cm or S/m in conductivity mode or  $\Omega$ .cm or  $\Omega$ .m in resistivity mode, respectively.

- **Cell constant (factory)**

The cell constant given at factory shipment is set.

When a new sensor is connected, set the new cell constant which is indicated on the sensor.

When a cell constant is changed, a calibrated cell constant (c.c. (adjusted)) will be the same value of the new cell constant (factory) after resetting an old one.

The cell constant is indicated on the sensor nameplate, etc. by either of the following two ways:

- **Cell constant indication and input methods**

- (1) When the cell constant itself is written on the sensor nameplate, enter it directly. (for electrodes SC211G, SC42, SC8SG, SC4A, SC4AJ, and SC210G)
- (2) When the “percentage of a deviation from the nominal cell constant ( $\pm \square.\square\%$ )” is indicated on the sensor nameplate, enter the cell constant as follows. (for electrode SC210G)

In case of the indication of a nominal cell constant of  $5 \text{ cm}^{-1}$  and a deviation value of (CORR.%=-1.1):

The input cell constant is  $5 \times (100 - 1.1) / 100 = 4.945$ ; enter this 4.945.

### 7.1.3 Temperature settings

Select the temperature element used for compensation from among Pt1000, Pt100, Ni100, 8k55, and Pb36 (JIS 6k). Select the same type as the temperature element that is actually connected.

If a thermistor is used for the temperature sensor, select Pb36 (JIS 6k).

Celsius ( $^{\circ}\text{C}$ ) or Fahrenheit ( $^{\circ}\text{F}$ ) temperature units are available. If the unit is changed, the following values are also recalculated automatically to the new unit:

- Manual temp.
- Reference temp.
- Temp. coefficient
- Temp. ranges in the matrix

## 7.1.4 Temperature compensation

- **Temperature compensation**

Two methods can be used: Automatic and Manual. Select Automatic when a temperature element is used or Manual when a manually set temperature is used.

### NOTE

---

When Manual is selected on the Temperature compensation, a process temperature should be set in the "Manual temp." A temperature shown on the Main display or the Home display is this manually set temperature.

---

- **Reference temperature**

Set a reference temperature to which the measured value must be compensated. Normally 25°C is used, so this temperature is chosen as the default value.

- **Process temperature compensation**

Select a temperature compensation method from among None, TC, NaCl, and Matrix. "None" does not perform the temperature compensation.

- **TC**

This method uses the linear compensation function.

For how to calculate a temperature coefficient of the compensation function, see "I Temperature compensation coefficient (TC)" on page App.2-1.

- **NaCl**

This method uses the standard temperature compensation function with NaCl solution.

For details, see "I NaCl (standard temperature compensation)" on page App.2-1.

- **Matrix**

This method uses the temperature compensation matrix, which is a table of the conductivity values at different temperatures and concentrations for a specific solution. The measured conductivity is compensated based on this matrix to the conductivity at the reference temperature.

Prepared matrixes and user-defined matrixes can be used. Two different user-defined matrixes are available.

For details, see "I Matrix" on page App.2-3.

When the measured temperature or the precompensated conductivity is out of the range, the temperature compensation error (warning) will be issued. This is not a device error.

For more details, see "■ Temperature compensation error" on App. 2-8.

Any two of these three methods can be set for conductivity measurement as "Temp.comp.1" and "Temp.comp.2". The result of either method can be output or displayed (see "7.2 Output setup" or "7.6 Display setup").

When "Measurement" is set to "Conduct. + Concentr." for the Measurement, only one method can be set.

---

**NOTE**

---

The temperature compensation is not performed around zero. In this case, a warning may be issued.

---

7

## 7.1.5 Calibration settings

The screen flow differs depending on the combination of objects to be measured.

- **Air adjust limit**

Generally, air calibration is not required. To avoid the effects of the cable on the measurement of lower conductivities such as pure water, a “zero” calibration with a dry sensor may be done.

When using a 4-electrode sensor, additional connections are required. Temporarily interconnect terminals 13 & 14 with each other and 15 & 16 with each other before making the adjustment. This is necessary to eliminate the capacitive influence of the cables. The links should be removed after this step is completed.

As the calibration is performed in air, the resistivity is infinite (open connection). Higher conductivity values than the air adjust limit indicate that the cell is not in air or is still wet. To prevent wrong air calibrations, a limit must be given here.

- **c.c. high**

High limit of the cell constant expressed as a % of the nominal value. During calibration this value is used to check if the calibrated cell constant remains within reasonable limits.

- **c.c. low**

Low limit of the cell constant expressed as a % of the nominal value. During calibration this value is used to check if the calibrated cell constant remains within reasonable limits.

- **Step Range**

Set the range over which the stability of a measured value is checked. If variations of a measured value over the stabilization time are within this set value, the measured value is judged to have stabilized.

- **Stabilization time**

During calibration, the stability of the measurement is constantly monitored. When variations of the value are within a value set in Step Range over this stabilization time set here, the value is regarded as being stable. If the value does not stabilize within 10 minutes, calibration is aborted.

- **Calibration interval**

Set the interval in which a new calibration must take place. If the interval set here is exceeded, the instrument will be notified according to the setting in “Calib. time exceeded” in the error configuration.

SC

## 7.1.6 Concentration

The “Concentration” can be set only when “Conduct. + Concentr.” or “Concentration” is selected for the Measurement in the Measurement setup menu.

The corresponding concentration given by a measured conductivity can be shown on the Main display or the Home display.



- **Concentration table**

Concentration can be calculated by using the temperature compensation matrix or the additional concentration table.

- **By using the temperature compensation matrix**

Set the “Additional table” to “Disabled”. The concentration can be obtained from the temperature compensation matrix (based on the relation between the conductivity at the reference temperature and the concentration).

Select Temp. compensation → Method, and then select Matrix. Next, choose a solution or User defined 1 or 2 (see Section 7.1.4). The concentration cannot be obtained by any other temperature compensation method (TC or NaCl).

- **By using the additional concentration table**

The additional concentration table indicates the relation between the conductivity and the concentration at the reference temperature. Set the “Additional table” to “Enabled”. The concentration can be obtained from the additional concentration table.

After entering values, select “Yes” for “Check values?”. Values are interpolated into empty cells. If any mandatory cells are left blank, an error will be issued. An error message is also issued if there is any error in the concentration table.

After completing entering values in the additional concentration table, set “Additional table” to “Enabled”.

- **Unit for table**

Select the concentration display units from among %, ppt, ppm, and ppb.

Changing the unit will not result in a re-calculation of the table. Reenter values in the additional concentration table.

## 7.1.7 Sensor diagnostic settings

This screen is used to set items relating to sensor diagnostics displayed on the screens invoked

by pressing .

Gauges are displayed for only parameters that have been enabled in “Sensor diag. settings.”

Parameters set to Disable are provided with a bar display.

The setting parameters include Progress time and Heat cycle. It is also possible to set the “Bad limits” of the progress time and heat cycle and the “Heat cycle temp” and “Heat cycle time” of the heat cycle.

## 7.2 Output setup

The general procedure is to first define the function of the output, Output or Simulate. Then, set the process parameters associated with the output. On the Output, an output of measured value is selected. On the Simulate, a simulation value can be set.

And, the parameters for HOLD function can be set on this setting.

- **Output**

The output signal is a current value specified by the following parameters.

- **Process parameter**

Available process parameters depend on the selected “Measurement” item in Measurement setup. Refer to Table 7.2.

The output of the selected process parameter is shown as a bar on the bottom of the Main display or the Home display. And its parameter symbol (for example, Conduct1-TC1 or Diff-Cond-TC1) is shown above the bar, too. When a selected process parameter is displayed as a measurement value, the top left number or character is turned to be white number or character on black background (for example, **1** or **R(1)**). (Refer to the section 1.2.)

**Table 7.2 List of Process Parameters**

Sensor	Measurement	Process Parameters
1 or 2	Conductivity	Conduct1 (2)-TC1
		Temperature1 (2)
		Conduct1 (2)-TC2
	Resistivity	Resistivity1 (2)-TC1
		Temperature1 (2)
		Resistivity1 (2)-TC2
	Concentration	Conduct1 (2)-TC1
		Temperature1 (2)
		Concent1 (2)-TC2
	Conduct. + Concentr.	Conduct1 (2)-TC1
		Temperature1 (2)
		Concent1 (2)-TC2
2	Conductivity Resistivity Concentration Conduct. + Concentr.	Calculated
		Redundant

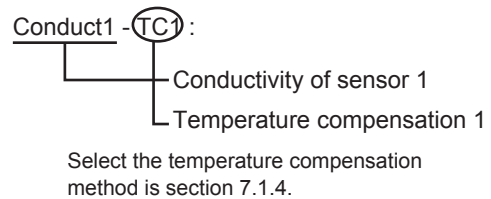

Calculated data and Redundant system are available when two modules are installed on the instrument. And, these functions are available when the “Conductivity” (or the parameter including conductivity) or the “Resistivity” is selected on the “Measurement” type setting. The parameter for the 1st module and the 2nd module should be the same. For wrong selection, an error is given.

When the process parameter is set at “Calculated” of “Redundant”, don’t change the “Measurement” type. If it is changed, the process parameter will go back to the default.

**<Calculated>**

For details, see section 7.7.

**<Redundant >**

On the Redundant system, when a sensor (Sensor 1) of the 1st module fails, the output is automatically switched to the output of the 2nd module.

After repairing the Sensor 1, manual reset of redundant system is necessary to return to the output of 1st module from the output of the 2nd module.

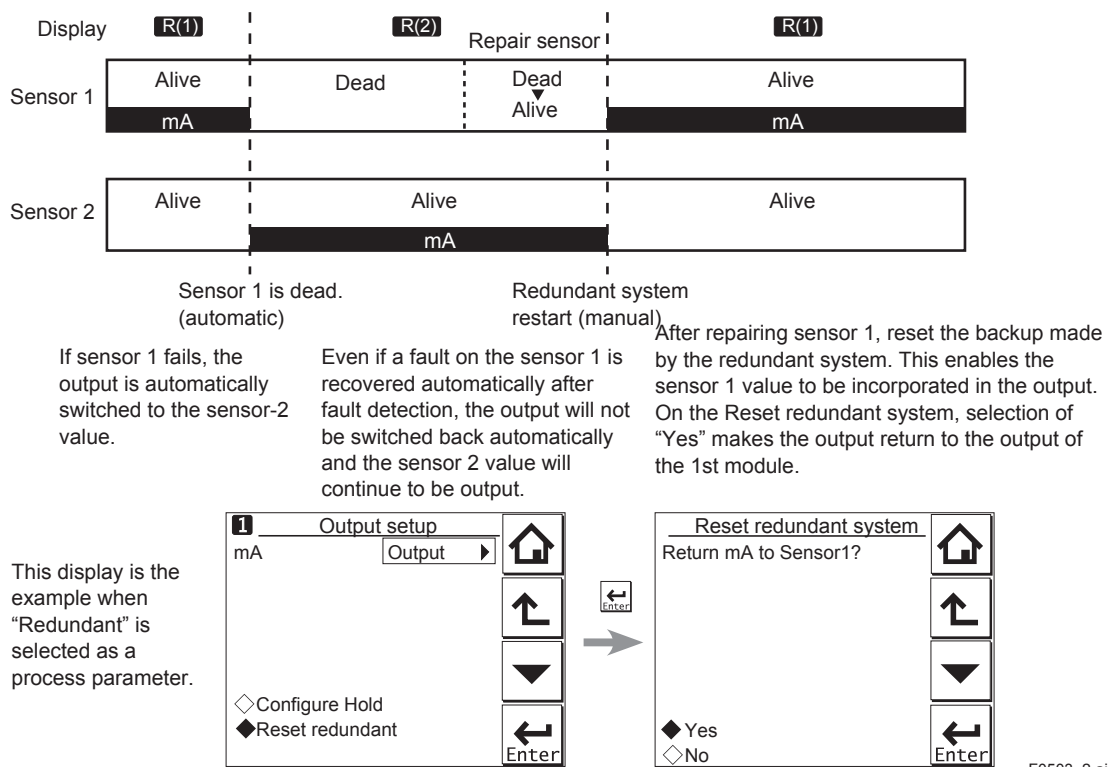

Figure 7.2 Redundant system

**Setup**

Select one of the output methods: Linear and Table.

Linear: Set the 0% and 100% values.

Table: This allows the configuration of an output curve by 21 points (5% intervals). (The 0% and 100% values must be entered.)

**Burn**

Select the designated output in case of a fault from among Off, Low, and High. See "7.3 Error configuration" to set the output.

Off: Output depends on the measured value.

Low: Output is fixed to 3.6 mA

High: Output is fixed to 22.0 mA.

**Damping time**

This is the time taken for a response to a step input change to reach 90% of the final value (attenuation time). Set this time in sec.

● **Simulate**

When this function is selected, an output of the instrument will be a fixed current value set in % of the output span. The output span range is -2.5% to 112.5% (3.6 mA to 22.0 mA).

When "Simulate" is selected, regardless of hold setting, the output is always simulated value.

■ **Configure Hold**

On the Configure Hold, settings are performed to hold of the mA output at a preset value. (Refer to the section 8.7.) This is enabled only if "mA" is "Output."

During the Commissioning or the Quick Setup, the mA output is automatically held. The preset value depends on a setting on the “Last or fixed”.

- “Last”: The preset value is a value measured just before hold condition.
- “Fixed”: The preset value is a value set in the “Fixed value mA”.  
When the “Fixed” is selected, set a mA value in the “Fixed value mA”.

Selection on the “Hold during Calibration” decides to activate or deactivate the hold function automatically during calibration.

- “Enabled”: Activation of the automatic hold function
- “Disabled”: No automatic hold function

## 7.3 Error configuration

In Error configuration, configure the statuses of various error causes.

This allows the system to notify the user of the occurrence of an error according to the status categories in the Error configuration.

Select a status category from among Off, Warn. (Warning), and Fault.

“Fault” automatically performs burn-out. When Burn has been set to Off (7.2 Output setup), only the error message is displayed.

“Warn.” displays an error message.

When selecting PH201G in the communication setting, make sure that the “Fail contact” setting is appropriate.

The settable causes of errors are determined based on the settings of the Sensor setup and Measurement setup, and a status category is set to the causes displayed in the Errors 1/3 to 3/3 screens.

**Table 7.3 Error configuration**

Display item	Description	Default
Conductivity too high (or Concentration)	Conductivity or resistivity is lower than the minimum limit.	Warn.
Conductivity too low (or Concentration)	Conductivity or resistivity is higher than the maximum limit.	Warn.
Temperature too high	Measured process temperature is higher than the maximum limit.	Warn.
Temperature too low	Measured process temperature is lower than the minimum limit.	Warn.
Polarization detec	Polarization of the electrodes is detected.	Off *
Calibr. time exceeded	Calibration time exceeds the calibration interval (see Section 7.1.5).	Off
USP	Conductivity exceeds the USP limit.	Off
Configuration error: 1st comp. matrix 2nd comp. matrix	The temperature compensation matrix is not defined properly (see Section 7.1.4).	Fault
Concentration table	The concentration table is not defined properly (see Section 7.1.6).	Fault

\*: SC210G does not have Polarization detect function. Setting this as default may cause an error message.

### CAUTION

If canceling an error configuration could be risky, do not cancel it as a dangerous situation may result.

---

**NOTE**

When setting the error limits of “Conductivity too high” and “Conductivity too low,” enter values obtained by dividing the conductivity value to be used as a limit value by the cell constant (given at factory shipment) of the sensor used (conductivity / cell constant). In resistivity measurements, set a value (resistivity x cell constant).

---

---

**NOTE**

The temperature compensation is not performed around zero. In this case, a warning may be issued. See “• For all temperature compensation” on App. 2-8.

---

**• USP**

The suitable error category for USP<645> monitoring can be set. When this is set, it is checked whether the non-temperature-compensated conductivity is higher than the limit value directed on the stage 1 of the procedure described on USP<645>. (Refer to the App.2)

**• USP safety margin**

The USP<645> monitoring can be modified by this setting. The percentage of the limit value of USP<645> serves as a safety margin. (Refer to the App.2)

## 7.4 Logbook configuration

In “Logbook configuration,” the user configures information to be saved to a logbook or initializes the logbooks.

Logbooks are used to keep an electronic record of events such as error messages, calibrations, and programmed data changes. By referring to this log, users can, for instance, easily determine maintenance or replacement schedules.

In “Logbook configuration,” the user can select “Off,” “1-1,” or “1-2” for each item of interest to be logged. (For sensor 2, select “Off,” “2-1,” or “2-2.”) This can be done for items displayed on the Settings logbook 1/3 to 3/3 screens. Assigning 1-1 or 1-2 to each item allows information to be organized and logged in a logbook.

---

**NOTE**

Some events such as power-on are saved into the logbook “1-1” or “2-1”. This logbook may be full earlier. It is recommended that important information be saved into the logbook “1-2” or “2-2”.

---

For “Erase logbook”, a specified logbook “1-1” or “1-2” can be erased individually.

When the “Warn if logbook full” is set to “Yes”, a warning is given when the logbook come to near full (maximum 13 pages).

---

**NOTE**

When the logbook gets full, the oldest information is erased automatically.

---

## 7.5 Advanced setup

Advanced setup is used to set functions relating to matters other than measurements such as the selection of settings, tag setting, password setting for protecting calibration and commissioning operations, date setting, and communication setting.

(“Factory setup” is for service engineers only; there is no item to be set by the user.)

### 7.5.1 Settings

In “Settings,” select an item to be set as the default value from among “No action,” “Load factory settings,” “Save user settings,” and “Load user settings.”

When the default values are loaded, the instrument will be restarted. (In the case of “Save user settings,” it will not be restarted.)

The following parameters are not included in the defaults:

- Tag
- The contents of all logbooks

#### NOTE

When the “Save user setting” is only selected, save of the user-set parameters will start at once.



To avoid wrong selection, operation in this Settings must be done by , not by touching the menu message.

If you select “Load factory settings,” the instrument will be set to the default settings at factory shipment.

When this item is selected, a screen prompting whether to restart is displayed. If this is no problem, press “Yes.” Then the “Loading ...” message appears and blinks and loading is started. When the factory settings have been loaded, the instrument will be restarted.

When “Save user settings” is selected, the current settings can be saved as the defaults.

When this item is selected, the user settings will start to be saved immediately. After saving the

parameters, press  or  to change the display because this save doesn't have restart function.

If “Load user settings” is selected, the settings saved as user settings can be set as the defaults.

When this item is selected, a screen prompting whether to restart is displayed. If this is no problem, press “Yes.” Then the “Loading ...” message appears and blinks and loading is started. When the user settings have been loaded, the instrument will be restarted.

### 7.5.2 Tag

A tag provides a symbolic reference to an instrument and is generally defined to be unique throughout the control system at one plant site. A tag can contain up to 12 alphanumeric characters. The default value is SC or FLXA21-SC. When two sensor modules are installed, each module can have their own tag numbers.

The tag is displayed at the top of the main and home displays.

### 7.5.3 Passwords

Calibration and commissioning operations can be separately protected by each password. To protect execute operations, enter a password in Execute's input field. To protect commissioning operations, enter a password in Commissioning's input field. By default, both input fields are empty. When a password input field is empty, operation is not password-protected. A password can contain up to 8 characters.

When you set a password, always take a note of it.

When a password is set, input of the password is necessary to enter the password-protected operation. After inputting the password, the display will change to an operator ID input display. When an operator ID is input, its operation is recorded into a logbook. The input of an operator ID is not necessary to enter the operation. An operator ID can contain up to 4 characters.

### 7.5.4 Date/Time

The Logbooks and trend graphs use the clock/calendar as a reference. The current date and time is set here. The time display format can be selected from among three types.

### 7.5.5 Communication

In "Communication," select the communication setting from among None, HART, and PH201G. The burn down current value is 3.6 mA.

#### NOTE

---

To make the change of "Communication" valid, turn off the power supply once, and reboot.

---

In the case of "None," there is not the problem even if you do not change it as "HART" of default value.

#### ■ HART

Select this menu when HART communication (HART 5) is made.

In the HART setup screen, specify the network address and set up parameters for SV, TV, and FV.

(PV is linked with the "process parameter" setting in "Output settings" and cannot be changed here.)

- **Network address**

For 1-to-1 communication, leave the default value [0] unchanged. For multi-drop where multiple HART devices are connected on a bus, set addresses in 1 to 15. In this case, the mA output will be fixed to 4 mA.

- **PV**

PV is a parameter selected for analog output; it cannot be changed here.

- **SV, TV, FV**

The SV, TV, and FV parameters are items that the user must set up. Selectable items differ depending on the sensor type in "Sensor setup" and settings in "Measurement setup."

If blank is selected for a parameter, items below that parameter must all be set to blank. If an item is blank, those below it cannot be set to a status other than blank.

For more information on HART communication, see the Technical Information (TI 12A01A02-60E) in the attached CD-ROM.

### ■ PH201G

Select this menu if the PH201G distributor is connected to the instrument.

In the PH201G setup screen, make settings for “Hold contact,” and “Fail contact.”

#### ● Hold contact

Select Disabled or Enabled.

When this item is enabled, the output will be held according to the setting of “Hold type” on the Hold setup screen.

#### ● Fail contact

Select a status from among “Fail + Warn,” “Fail only,” and “Disabled.”

This setting depends on the error configuration. See “7.3 Error configuration.”

“Fail” corresponds to “Fault.”

## 7.5.6 Factory setup

For “Factory setup,” there is no item to be set by the user.

### NOTE

This menu is for service engineers only. This section is protected by a password. Attempting to change data in the factory adjustment menu without the proper instructions and equipment could result in corruption of the instrument setup and damage the performance of the unit.

## 7.6 Display setup

This screen is used to make various settings relating to screen display.

### NOTE

Settable items differ depending on settings in “Measurement setup.”

### 7.6.1 Main display (Dual display, Individual display)

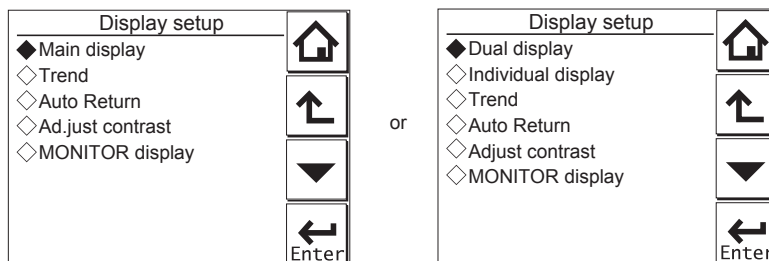

Figure 7.3 Display setup screens for a single module (left) and two modules (right)



- **Main display**

When one module is installed on the instrument, only the Main display is available.

Three measurement values can be set to display on the Main display as a primary value (1st line), a second value (2nd line) and a third value (3rd line) respectively.

On the “Additional text”, a text of up to 12 alphanumeric characters can be assigned to each measurement value.

Additional texts are displayed on the Main display, and are useful for identifying measurements. In some cases, not all 12 characters can be displayed due to the letters; check the texts displayed on the Main display after setting. If a part of the text is missing, adjust the number of characters.

- **Dual display**

This screen is used to set items to be displayed in the top part (1st row) and bottom part (2nd row) of the Home display. These settings are available when two sensors are installed in the instrument.

When the “Empty” is selected for the 2nd row, the Home display can not be displayed.

- **Individual display**

When two modules are installed on the instrument, display items on the Main display for each module can be set on these settings.

On the “SC1 display” or “SC2 display” screen, three measurement values can be set to display on each Main display as a primary value (1st line), a second value (2nd line) and a third value (3rd line) respectively.

On the “Additional text”, a text of up to 12 alphanumeric characters can be assigned to each measurement value.

Additional texts are displayed on the Main display, and are useful for identifying measurements. In some cases, not all 12 characters can be displayed due to the letters; check the texts displayed on the Main display after setting. If a part of the text is missing, adjust the number of characters.

## 7.6.2 Trend

This screen is used to make settings for the Trend Graph Screen.

Set the process parameters to be displayed for each trend. They can be set for the 1st to 3rd trends. When all three process parameters are set “Empty”, there is no trend display (no trend button).

- **X-axis: Timing**

Select the X-axis timing’s time span on the trend graph display from a list.

- **Y-axis: Limits**

Set the Y-axis high and low limits on the trend graph display on a Trend screen basis.

### **NOTE**

---

Updating the trend display setup resets the current trend graph and starts a new one.

---

### 7.6.3 Auto Return

When no operation is performed for the time set in “Auto Return”, the display returns to the Monitor display (or to the Main display when the MONITOR display is disabled) and the analyzer returns to a normal measuring mode. (When the Trend display is selected, the Auto Return doesn't work.)

Select the time from among Disable, 10 min, and 60 min. When the Auto Return function is not used, select “Disable.”

#### NOTE

A default is “10 min”. When maintenance like a calibration that may take much time is performed, “60 min” or “Disable” is recommended to be selected.

### 7.6.4 Adjust contrast

The LCD screen contrast can be adjusted.

Pressing the ▲ ▼ keys adjusts the contrast in 11 levels from +5 to –5 (including the default value of “0”).

### 7.6.5 MONITOR display

Select “Enable” so that the Monitor display becomes available. A default is “Enable”.

During Hold condition and a warning/fault condition, the Main display or the Home display is displayed to indicate the condition.

## 7.7 Calculated data setup

On this setup, parameters can be set for calculated data.

When two modules are installed on the instrument, the calculated data can be set for conductivity values or resistivity values measured by two sensors.

On the Calculated data setup screen, select one kind of calculations as shown on the Table 7.4.

For resistivity, select “Differential” or “Average”.

Table 7.4 Calculation

Function	Arithmetic expression	Indication *
Differential	(value of the sensor 1) – (value of the sensor 2)	Diff
Average	(value of the sensor 1 + value of the sensor 2) / 2	Ave
Ratio	(value of the sensor 1) / (value of the sensor 2)	Ratio
Passage(%)	(value of the sensor 2) / (value of the sensor 1) x 100	Pass
Rejection(%)	(value of the sensor 1 – value of the sensor 2) / (value of the sensor 1) x 100	Reje
Deviation(%)	(value of the sensor 2 – value of the sensor 1) / (value of the sensor 1) x 100	Dev
pH calc.(VGB)	pH = 8.6 + log {(value of the sensor 1) – (value of the sensor 2) / 3}	VGB

\* Parameter symbol at the bar display of analog output which is displayed at the bottom of the Main display or the Home display when a calculated data is selected as a process parameter on the “mA (Output)” setup screen.

To display the calculated result, select “Calculated” on the Dual display screen. (Section 7.6.1.) (The setting on the “Individual display” has no effect.)

While displaying a calculated data, measurement value of the sensor 1 or sensor 2 can be

checked on the each sensor's display with pressing  or  at the lower right on the Main display.

---

Pressing  returns the display to the original calculated data display.

A calculated data can be set as a process parameter on the “mA (Output)” setup screen. (Section 7.2.)

# 8. CALIBRATION OF SC (Conductivity)

The cell constant of a conductivity meter does not change during operation, as long as it remains undamaged, and clean. Therefore, it is vital that in any calibration check, the first step should be to clean the sensor, or at least to check its cleanliness. After cleaning, ensure that the sensor is carefully rinsed in distilled water to remove all traces of the cleaning medium.

The cell constant is indicated on the nameplate or cable label of the SC sensor.

For input of the cell constant, see section 7.1.2.

## NOTE

A default is “10 min” for “Auto Return”. When maintenance like a calibration that may take much time is performed, “60 min” or “Disable” is recommended to be selected. (Refer to the section 8.6.3.)

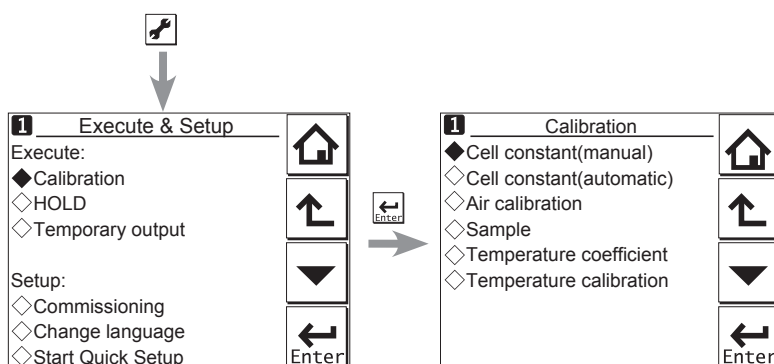

Figure 8.1 Calibration

Calibration for conductivity can be selected from Cell constant (manual), Cell constant (automatic), Air calibration, and Sample. In most cases, Air calibration is not required.

## NOTE

The standard instrument to be used in calibration with a process solution should always be accurate. Yokogawa recommends that the Model SC72 pocket conductivity meter be used for this purpose.

Where temperature compensation 1 (SC1) and temperature compensation 2 (SC2) have been configured, the configured temperature compensation is effective even during calibration. Therefore, the reading is the value converted to a conductivity value at the reference temperature set in Temperature settings.

There are temperature compensation 1 (SC1) and temperature compensation 2 (SC2), but this does not mean that calibration is required twice. It means that either SC1 or SC2 temperature compensation should be selected and calibration should be made once to obtain the cell constant. The cell constant after calibration can be checked on the Detail screen.

## NOTE

When a sensor is exchanged or replaced, sensor wellness data should be reset.

When a sensor is replaced, the replacement can be recorded manually into a logbook. (Refer to the figure 6.9.)

---

## 8.1 Cell constant (manual)

The intention of this calibration routine is to fine-tune a sensor for which only the nominal cell constant is known, or to recalibrate a sensor that has been changed (or damaged) during operation. Choose the 1st or 2nd temperature compensation to suit the calibration solution used. The solution with an appropriate precision should be prepared or purchased. Allow the sensor to reach stable readings for both temperature and conductivity before adjusting to the value of the corresponding calibration solution.

Calibration here is performed by measuring a solution with known conductivity at the set reference temperature. The calibration solution of an accurate concentration should be prepared by dissolving a certain amount of solute in water. Allow the conductivity to become stable at the set reference temperature (initial setting of 25°C) of the instrument and obtain the conductivity from literature data, etc. Appendix 2 shows the conductivity values of sodium chloride (NaCl) as a typical example.

## 8.2 Cell constant (automatic)

This routine is built around the test method described in International Recommendation No. 56 of OIML (Organisation Internationale de Metrologie Legale). It allows the direct use of the solutions prescribed in the test method, automatically selecting the appropriate temperature compensation. The look-up table is used to find an appropriate conductivity reading for the measured temperature. See Appendix 2 for OIML solutions.

## 8.3 Air calibration

It is not necessary to conduct general air calibration unless the cable length is long and a low conductivity needs to be measured.

With the clean dry cell in open air, the reading should be zero. The air cal compensates for excess cable capacitance, and gives a better accuracy at low readings. This should be done when a sensor is installed or replaced. After some time in service, a dirty sensor may well show a high zero offset because of fouling. Clean the sensor and try again. Moreover, air calibration should be made in an environment free of electromagnetic interference.

### NOTE

---

The temperature compensation is not performed around zero. In this case, a warning may be issued. See “• For all temperature compensation” on App. 2-8.

---

## 8.4 Sample

With the sensor in situ, a sample can be taken for laboratory analysis. Sample calibration records the time and reading, and holds these in memory until the analysis has been completed. The laboratory data can then be entered regardless of the current process value, without the need for calculations.

When sample calibration is made with temperature compensation activated, the types of temperature compensation for laboratory analysis equipment should be matched. Use of a different type of temperature compensation between equipment causes an error. The standard conductivity meter to be used should always be based on the accurate and same temperature compensation calculation method. Yokogawa recommends that the Model SC82 pocket conductivity meter be used for this purpose.

Press [Take Sample] to record a collected sample value in memory. Re-enter the Sample Cal. screen and press [Start calibration] to perform a sample calibration. This updates the recorded data.

## 8.5 Temperature coefficient

Simply input the solution conductivity at the reference temperature (TR) after allowing the sensor to stabilize at elevated temperatures. The FLXA202/FLXA21 will calculate the temperature coefficient for you. The ideal temperature for this calibration is the normal process value (TP).

This calibration is enabled if the Temperature Compensation is set to "TC." (Section 7.1.4)

## 8.6 Temperature calibration

In order to make the most accurate measurements, it is important to have a precise temperature measurement. This affects the display of temperature, and the output signal (when used). More important, however, is the temperature compensation, and calibration accuracy.

The temperature of the sensor system should be measured independently with a high precision thermometer. The value of "Measured temperature" should then be adjusted to agree with the reading (zero offset calibration only).

For best accuracy, this should be done as near to the normal operating temperature as possible.

## 8.7 HOLD

The FLXA202/FLXA21 has a function to hold the mA output at a preset value (default: "Last"). Use this menu to hold the output.

For the settings, see "■ Configure Hold" on page 7-8.

During commissioning or quick setup, the output is automatically held.

Setting "Hold during Calibration" to "Disabled" deactivates the hold function during calibration.

Press  to select Execute: HOLD and then choose Manual Hold ON or Manual Hold OFF. This allows you to set up manual hold.

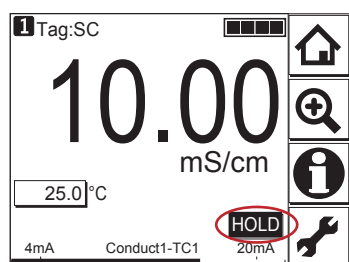





Figure 8.8 Example of the display with the manual hold enabled

To cancel manual hold, press the lit  section on the Main display.

## 8.8 Temporary output

If measurement cannot be made due to replacement of one of the sensors, assignment of mA output can be temporarily changed from the currently setup sensor to the other sensor. This feature is enabled only when two sensors are connected.

Press  to select Execute: Temporary output and then choose the process parameter to be assigned on the Temporary output screen.

When process parameter assignment has been modified, the  indication at the upper left of the screen changes to .

The feature is disabled the moment the screen returns to the Main display, and the setting (process parameter in mA output setting) returns to the original condition.

# 9. OPERATION OF ISC (Inductive Conductivity)

This chapter describes the screen operations of ISC, the object to be measured.

Further details of screen operations can also be found in section 1.2.

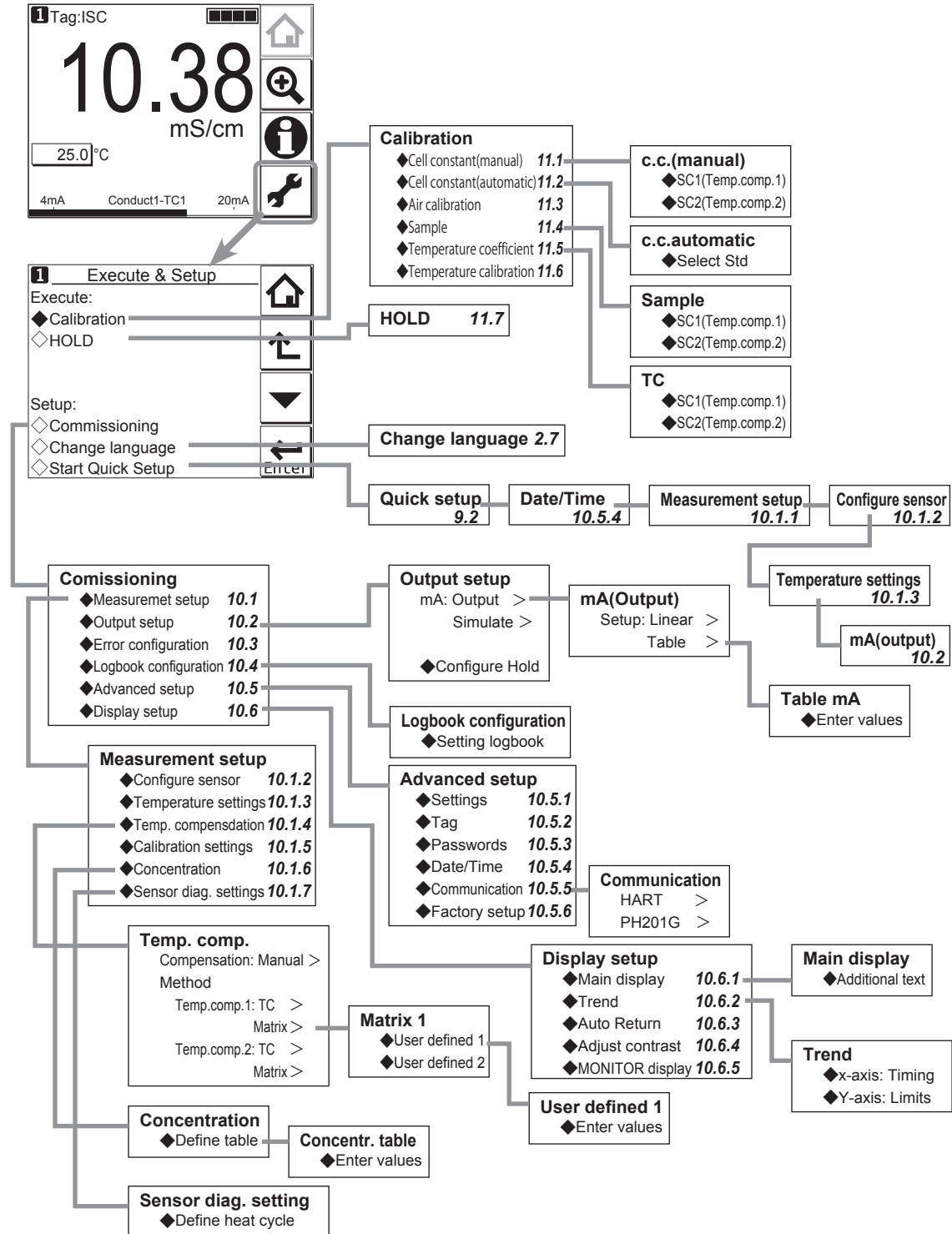

Figure 9.1 Menu structure of ISC (the number after the item refers to the relevant section)



---

## 9.1 Change language

The screen is set to display English at factory shipment; if you wish to use the FLXA202/FLXA21 in another language, first select a language as described in section 2.7.

## 9.2 Quick setup

The Quick setup screen is used to set up the basic items you want to set up first, such as the date/time and sensor settings. The detailed settings are described in chapter 11, Commissioning.

You may leave the Quick setup now and return to it later; however, it is recommended to perform the quick setup first.

Each time the FLXA202/FLXA21 is started up, this screen is displayed. If it is not necessary to change the setup, press No or .

### NOTE

---

When no operation is performed for 10 minutes or 60 minutes (depending on the setting of “Auto Return”), the display except Trend display automatically changes to the Monitor display (or to the Main display when the MONITOR display is disabled).

---

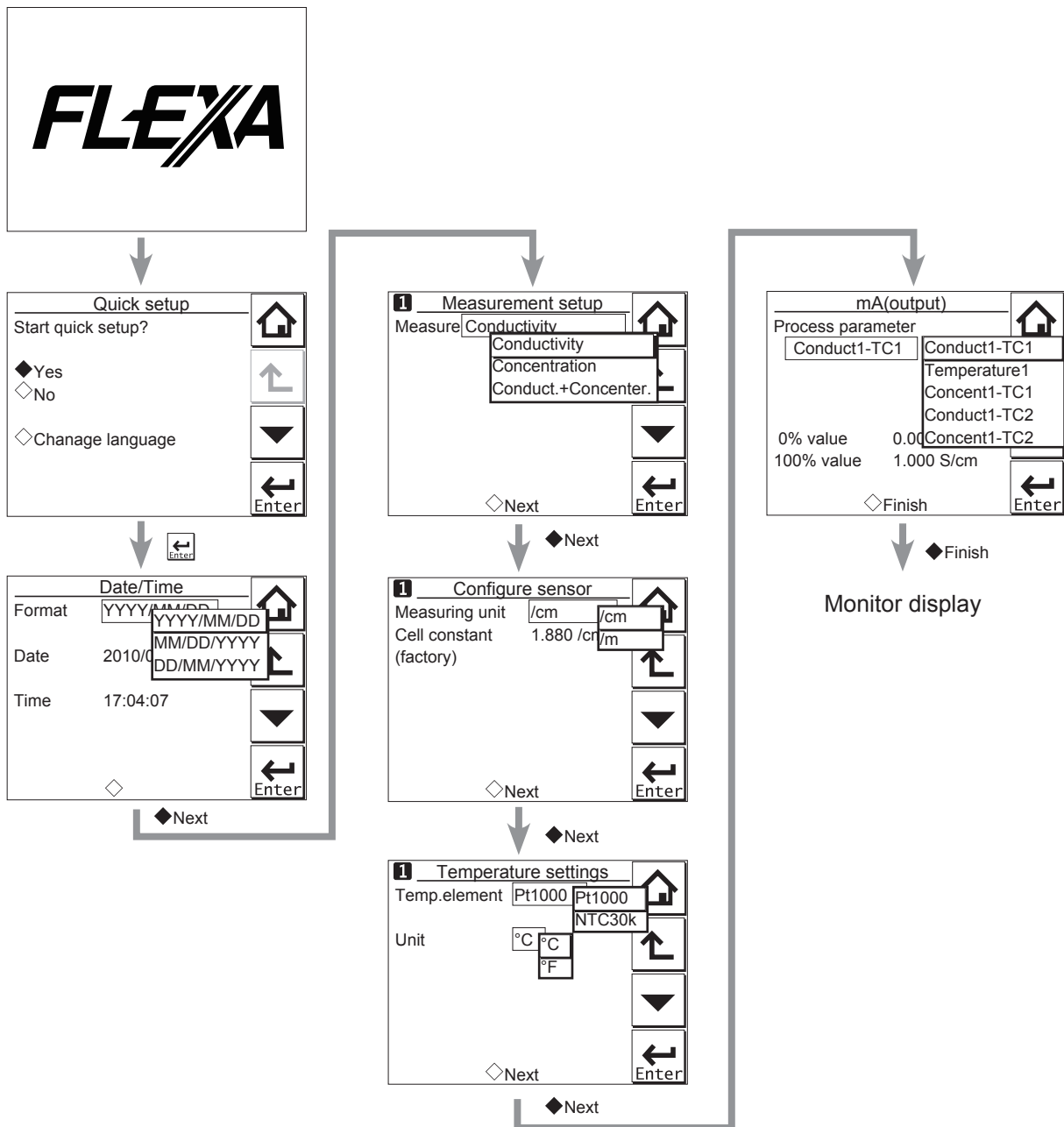

Figure 9.2 Quick setup

### ■ Date/Time

The date display format can be selected from among the three types.

Enter the date or time of day by using the numerical keys.

For details, see section 10.5.4.

### ■ Measurement setup

Select a suitable measurement parameter from among those displayed and set it up.

Measurement parameter setup can be made only when “ISC” is selected on the Sensor setup screen.

For details, see section 10.1.1.

## ■ Configure sensor

The measurement units can also be selected from among “/cm” and “/m”.

The cell constant (factory default) is determined by factory calibration made during manufacturing.

The cell constant is indicated on the sensor. If a new sensor is used, the cell constant indicated here should be changed. When this value is changed, the real cell constant will also be changed.

For details, see section 10.1.2.

## ■ Temperature settings

Select a suitable temperature element from among those displayed and set it up.

Celsius (°C) or Fahrenheit (°F) temperature scale can be selected.

For details, see section 10.1.3.

## ■ mA (output)

Select an appropriate process parameter from among those displayed and set it. The mA output has been set to 0 – 500  $\mu$ S/cm or 0 to 20  $\Omega$  cm at factory shipment. If a high resolution is required in a consistent measurement process, set this parameter to a value suitable for the process.

For details, see section 10.2.

## 9.3 Main display and Monitor display

Pressing  changes the screen to the Main display shown in Figure 9.3.

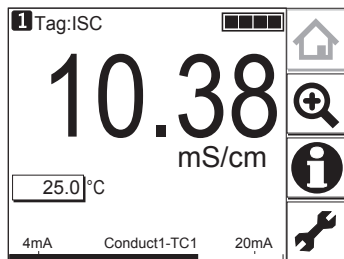



Figure 9.3 Example of main display

On the Main display, pressing  of the 2nd or 3rd display item causes the 1st display item to be replaced by the selected item.

### NOTE

Measured values to be displayed in the 1st to 3rd display items depend on the user definition (see section 10.6.1). In the default condition, the 1st display item is conductivity, the 2nd display item is temperature, and the 3rd display item is empty.

When the MONITOR display is enabled (see section 10.6.5), pressing the 1st display item on the home display or the main display changes the display to the Monitor display with the enlarged font of the measured value.

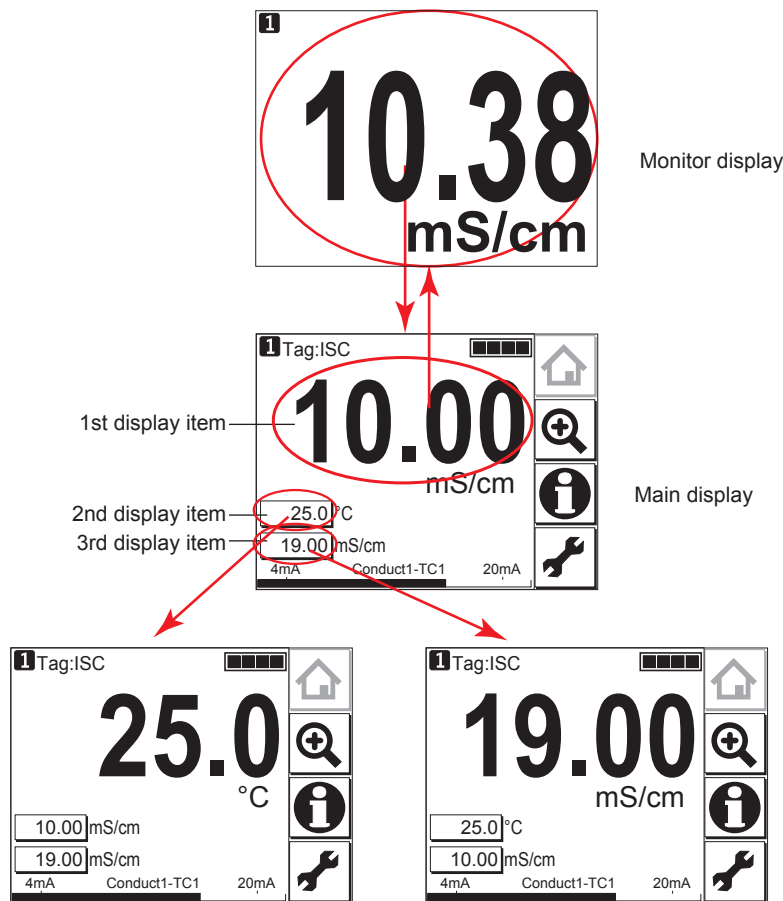

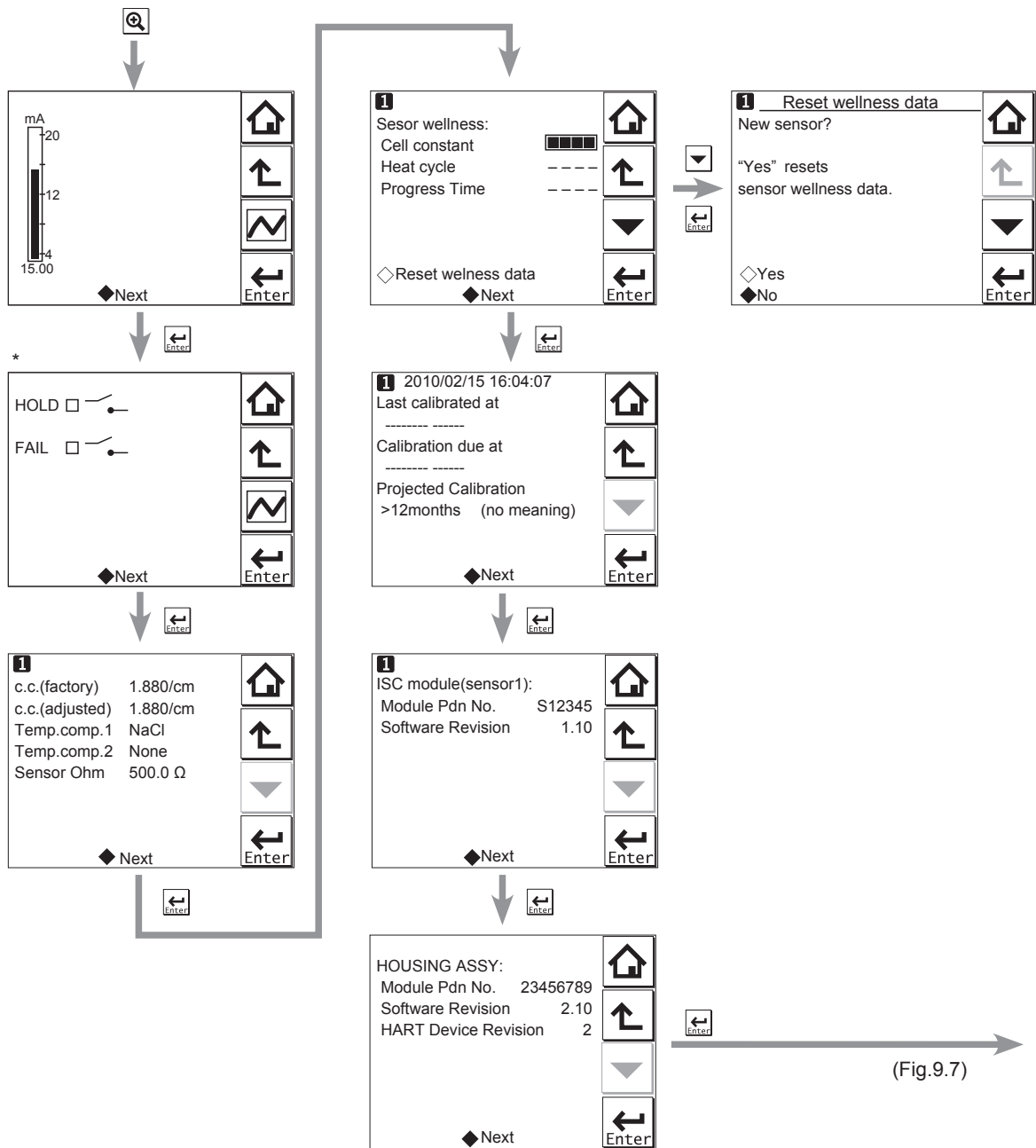

Figure 9.4 Change display

## 9.4 Zooming in on details

Pressing  on the Main display allows you to check detailed instrument information (instrument information such as setup, sensor diagnosis, calibration, and module productions number) through a transition of screens as shown in Figure 9.5.

In case of trouble, when you contact your nearest Yokogawa service center, please inform us of the module and FLXA202/FLXA21 software revision displayed on the Detail screen and other display information as well as the module productions number indicated on the nameplate attached to the instrument.



(Fig.9.7)

\*: This screen is displayed only if the PH201G distributor is used and "PH201G" is selected in communication setup.

Figure 9.5 Detail display

### ■ Current output mA

= current output in mA. The range and function of this mA output can be set in Commissioning → Output setup → mA.

For details, see section 10.2.

### ■ Contact status

This screen is displayed only if the PH201G distributor is used and "PH201G" is selected in communication setup.

### ■ c.c. (factory)

This parameter displays the cell constant (factory setting).

The cell constant (factory setting) is determined by factory calibration made during sensor manufacturing. This value can be set in Commissioning → Measurement setup → Sensor setup.

The cell constant is indicated on the sensor or cable label.

### ■ c.c. (adjusted)

This parameter displays the cell constant (adjusted).

The cell constant (adjusted) is a cell constant that has been calibrated and is set by calibration action.

When the system's cell constant is adjusted on-line by calibration using a process solution or buffer solution, a new cell constant is logged here. The difference between this value and the default value set at factory shipment will not be large. If there is a large difference between them, check whether the sensor is broken or contaminated.

### ■ Temp. comp. 1

This parameter shows the temperature compensation method for 1st measurement. The setting is made in Commissioning → Measurement setup → Temp. comp.

### ■ Temp. comp. 2

This parameter shows the temperature compensation method for 2nd measurement. The setting is made in Commissioning → Measurement setup → Temp. comp.

2nd measurement does not imply that two measurements can be made individually, but it means that two types of compensation methods can be configured, which enables two phases to be monitored accurately in the same process. An example is monitoring the switching between process and washing solutions.

### ■ Sensor Ohm

This parameter represents the non-compensated resistance of the sensor.

### ■ Sensor wellness

At the Sensor wellness window, the soundness of a module is displayed. A larger number of ■ in each gauge indicates that the parameter concerned is sound. A gauge is indicated for only those parameters whose sensor wellness setting is "enabled," while a bar (---) is displayed if the sensor wellness setting is "disabled."

Sensor wellness setup can be made in Commissioning → Measurement setup → Sensor diag. settings. For details, see section 10.1.7.

The "Reset wellness data" button can reset wellness data.

When a sensor is exchanged or replaced, sensor wellness data should be reset.

### NOTE

When a sensor is replaced, the replacement can be recorded manually into a logbook. (Refer to the figure 9.7.)

**Last calibrated**

= date on which the last sensor calibration was performed. The displayed value of the Zero is the result of this calibration. The displayed value of Slope was calibrated on this date only if the last calibration was a 2-point calibration.

**Calibration due**

= the date when the calibration must be done next according to the settings of the calibration interval. The calibration intervals are set in Commissioning → Measurement setup → Calibration settings → Limits and timing.

**Projected replacement**

The projected maintenance function predicts the date when the sensor unit will need cleaning or recalibrating for maintaining measurement accuracy. The function checks the cleanliness of the sensor by monitoring the cell constant after calibration. Clean the sensor before the predicted date.

The function predicts the dates when the cell constant will cross the upper or lower limits and displays the predicted date with the status (the status is displayed in parentheses).

As shown in Figure 9.6, the date is predicted based on the intersection point of the upper or lower limits and the extrapolated line of the values obtained by the least squares method.

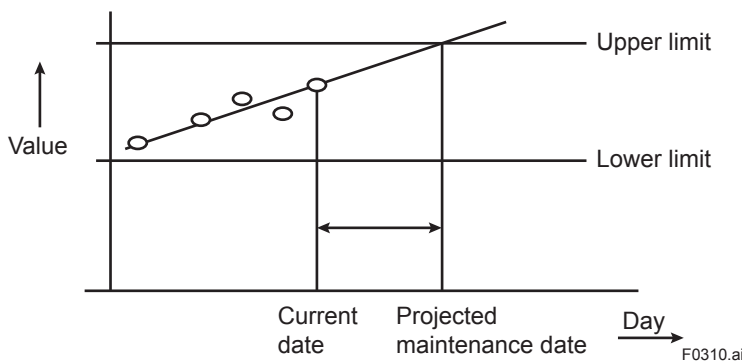

Figure 9.6

The status shows the certainty of the projected maintenance date in terms of the correlation coefficient R. Tables 9.1 and 9.2 show respective display patterns.

Table 9.1 Display pattern of the projected maintenance date

Projected date	--	0-1 month	1-3 months	3-6 months	6-12 months	Over 1 year
----------------	----	-----------	------------	------------	-------------	-------------

-- : cannot be predictable due to insufficient data

Table 9.2 Display pattern of the status

Status	(----) (R < 0.50)	(Poor) (0.50 ≤ R < 0.70)	(Reasonable) (0.70 ≤ R < 0.85)	(Excellent) (0.85 ≤ R < 1.00)
--------	----------------------	-----------------------------	-----------------------------------	----------------------------------

**ISC module (sensor)**

With this screen, you can check the module productions number and software revision of the installed module.

**HOUSING ASSY**

With this screen, you can check the module productions number, software revision, and HART device revision of the housing assembly.

## Read logbook

The FLXA202/FLXA21 has two types of logbook per sensor to store history information on events, such as changed settings and calibrations.

By selecting one of the logbooks that you wish to check, you can retrieve and check this information. Storage of history information on each event in a logbook or which logbook to use for storage can be set up on the Configure logbook screen. For details, see section 10.4.

History information on events are automatically stored on the preset conditions.

In addition to this storing, following three messages can be manually stored in the logbook;

"Sensor washed by hand", "Module replaced", "Sensor replaced"

To store these messages, press  and select one of three messages from the Item on the Memorandum screen. Its event date/time will be the time when a message is selected and entered.

When a password for Commissioning is set on the passwords' setup, pressing  requires entering the password. (Refer to the section 10.5.3.)

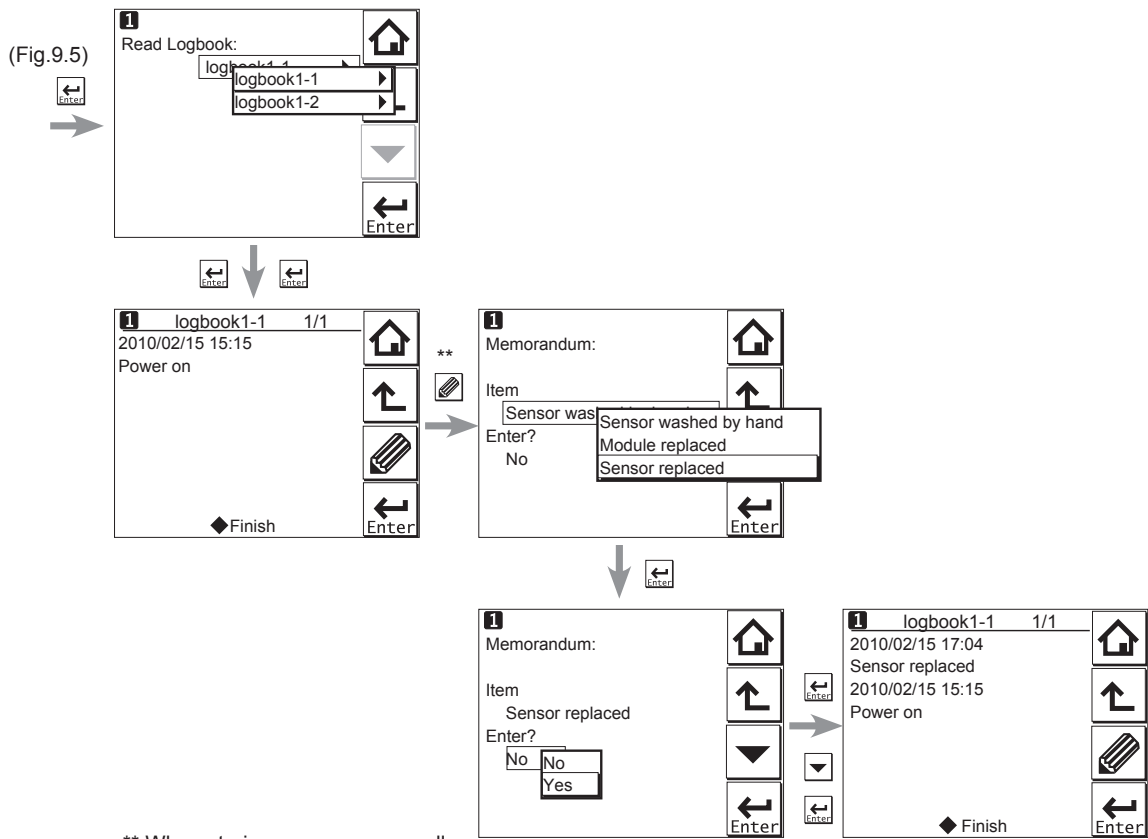



Figure 9.7 Detail display (continued)

## 9.5 Trend graphics

Pressing  on the Zoom display changes the display to a graphical mode in which the average measured value is shown on a time scale. The "Live" value is also digitally displayed in a text box. The time scale (X-axis) and the primary value scale (Y-axis) are set in the "DISPLAY SETUP" menu (Section 10.7.2).



The screen displays the trend of up to 41 averages of the measurement for each time interval. The FLXA202/FLXA21 samples the measurements every second. The trending graphic also shows the maximum and minimum measured values in that interval.

For example, if the time scale is set to 4 hours, then the trend is shown for 4 hours prior to the actual measurement. Each point on the trend line represents the average over  $4 \times 60 \times 60 / 41 = 351$  measurements (seconds).

**NOTE**

Updating the trend screen setup resets the current trend graph and starts a new one.

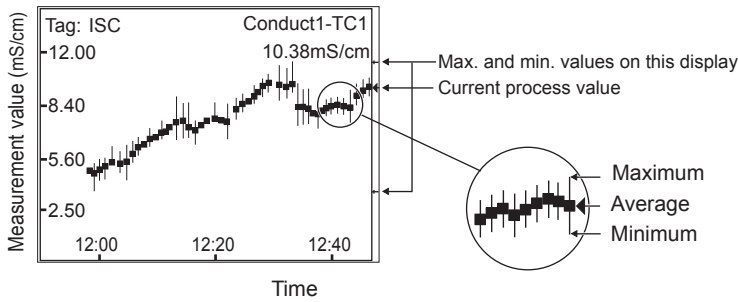

**Figure 9.8** Trend screen

The 1st display item data on the Main display is shown as a graph. Touching any point on the display changes the display to the 2nd display item data (and to the 3rd display item data if set) and then returns to the Main display.

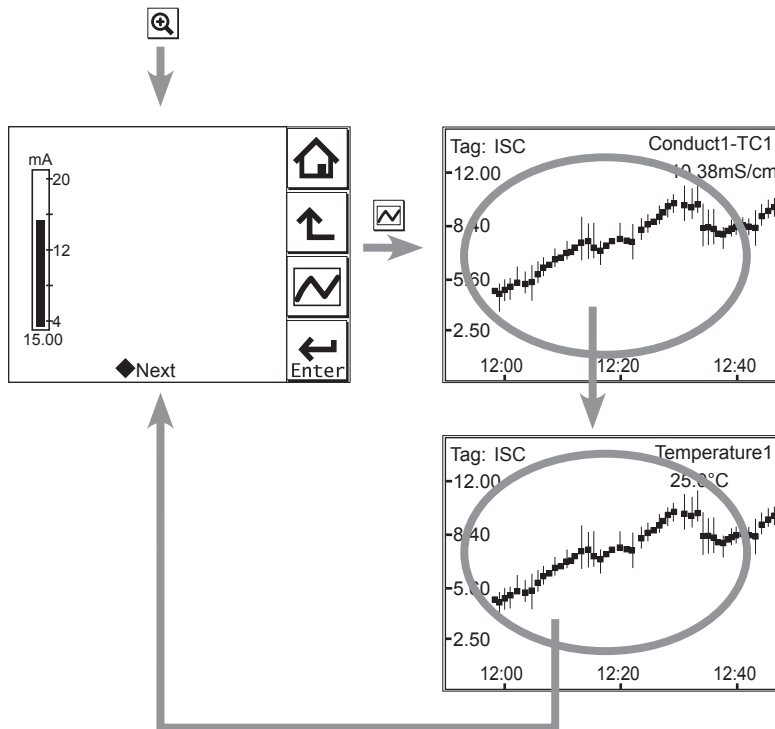

**Figure 9.9** Trend graphics

## 9.6 Instrument status screen

In the  field of the Main display, the  (Warning) or  (Fault) sign appears according to the instrument status. Upon pressing the displayed button, detailed information of the relevant status appears.

See “■ Information button” on page 1-10.

## 9.7 Calibration and Commissioning

Allows you to calibrate and configure the instrument. These operations can be protected with a password.

For details on the password, refer to section 10.5.3.

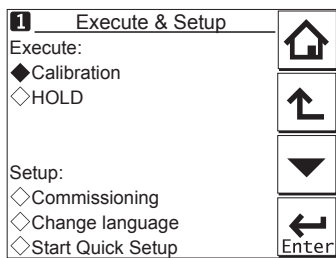





Figure 9.10 Execute & Setup

Pressing  changes the display to the Execute & Setup screen.

Browse through the menu items by pressing  until you find the desired menu and then press  to enter that menu. It is also possible to enter a desired menu by pressing the  symbol beside the menu item.

For calibration (HOLD), read chapter 11, and for commissioning, read chapter 10.



# 10. COMMISSIONING OF ISC (Inductive Conductivity)

This chapter describes how to check and change settings from the Commissioning screen. When you move to the Commissioning screen, the output is held.

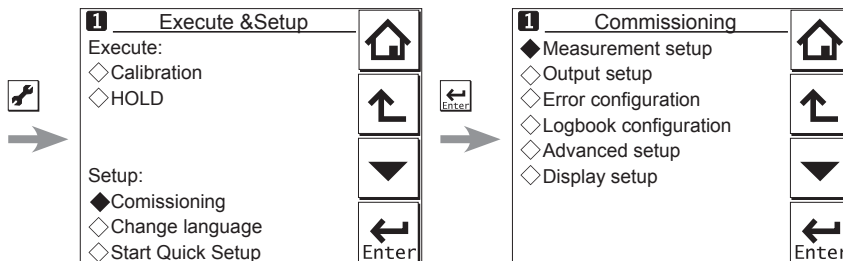

Figure 10.1 Commissioning screen

Operations in Commissioning can be password-protected. If you set up a password, always take a note of it. For details on setting a password, see section 10.5.3.

Figure 9.1 shows the commissioning procedure. Before changing any parameters, read the relevant sections in this document and understand how the change of parameters affects the performance of this instrument. If you set a wrong value, return it to the default setting or value and then set it again.

On the first startup, the parameters are all default values configured at the factory. Check the parameters in Table 10.1 and change any of them if necessary depending on the sensors to be connected and the purpose of use.

Set "Measurement" first. Some measurement parameters and relevant options change accordingly. The underlined parameters in Table 10.1 are used for the quick setup.

The default values and setting ranges are listed in the "User setting table of ISC" in the attached CD-ROM.

After confirming that the instrument operates normally with the parameters, print out the "User setting table of ISC" and write down these parameters in the column of User Settings.

All user parameters can also be saved in the instrument.

Select Commissioning → Advanced setup → Settings → Save user settings (see Section 10.5.1).

**Table 10.1 Menu Structure and Default Values in “Commissioning”**

Parameter		Ref. sect.		
Measurement setup	<u>Measurement</u>	10.1.1		
	Configure sensor	<u>Measuring unit</u>	10.1.2	
		Cell constant (factory)		
	Temperature settings	<u>Temp. element</u>	10.1.3	
	Temp. compensation	Compensation	10.1.4	
		Reference temp.		
		Method		
	Calibration settings	Limits:	Air adjust	10.1.5
			c.c.	
		Timing:	Step Range	
			Stabilization time	
	Concentration	Additional table	10.1.6	
Unit for table				
Sensor diag. settings	Process time:	10.1.7		
	Heat cycle:			
	Define heat cycle			
Output setup	mA	Output	10.2	
		<u>Process parameter</u>		
		Setup		
		Linear		<u>0 % value</u>
				<u>100 % value</u>
		Table		
		Burn		
		Damping time		
Simulate	Simulation perc.			
Configure Hold				
Error configuration		10.3		
Logbook configuration		10.4		
Advanced setup	Settings	10.5.1		
	Tag	10.5.2		
	Passwords	10.5.3		
	Date/Time	10.5.4		
	Communication	HART	10.5.5	
		PH201G		
Factory setup	10.5.6			
Display setup	Main display	10.6.1		
	Trend	10.6.2		
	Auto Return	10.6.3		
	Adjust contrast	10.6.4		
	MONITOR display	10.6.5		

**NOTE**

All the parameters for the quick setup (underlined ones in Table 10.1) are crucial for measurement. If you change any of them, other parameters may be initialized. For the parameters that may initialize other values, see Appendix 3.

## 10.1 Measurement setup

This section describes how to set up various parameters relating to measurements. Measurements are performed based on the measurement parameter setup.

## 10.1.1 Measurement

Select a measurement parameter from Conductivity, Concentration, and Conduct. + Concentr. The setting of the measurement parameter changes the menu structure in Error configuration, Display setup, etc. accordingly.

## 10.1.2 Configure sensor

This section describes how to configure the sensor to be connected.

- **Measuring unit**

Either /cm or /m can be chosen here.

The process values will be expressed in S/cm or S/m.

- **Cell constant (factory)**

The cell constant given at factory shipment is set.

When a new sensor is connected, set the new cell constant which is indicated on the sensor.

When a cell constant is changed, a calibrated cell constant (c.c. (adjusted)) will be the same value of the new cell constant (factory) after resetting an old one.

## 10.1.3 Temperature settings

Select the temperature element used for compensation from among Pt1000 or NTC30k. Select the same type as the temperature element that is actually connected.

Celsius (°C) or Fahrenheit (°F) temperature units are available. If the unit is changed, the following values are also recalculated automatically to the new unit:

- Manual temp.
- Reference temp.
- Temp. coefficient
- Temp. ranges in the matrix

## 10.1.4 Temperature compensation

- **Temperature compensation**

Two methods can be used: Automatic and Manual. Select Automatic when a temperature element is used or Manual when a manually set temperature is used.

### NOTE

When Manual is selected on the Temperature compensation, a process temperature should be set in the "Manual temp." A temperature shown on the Main display is this manually set temperature.

- **Reference temperature**

The temperature compensation function converts the measured conductivity value to that at the reference temperature. The reference temperature can be changed. The default value is 25°C.

- **Process temperature compensation**

Select a temperature compensation method from among None, TC, NaCl, and Matrix. “None” does not perform the temperature compensation.

- **TC**

This method uses the linear compensation function.

For how to calculate a temperature coefficient of the compensation function, see “● Temperature compensation coefficient (TC)” on page App.3-1.

- **NaCl**

This method uses the standard temperature compensation function with NaCl solution.

For details, see “● NaCl (standard temperature compensation)” on page App.3-1.

- **Matrix**

This method uses the temperature compensation matrix, which is a table of the conductivity values at different temperatures and concentrations for a specific solution. The measured conductivity is compensated based on this matrix to the conductivity at the reference temperature.

Prepared matrixes and user-defined matrixes can be used. Two different user-defined matrixes are available.

For details, see “● Matrix” on page App.3-3.

When the measured temperature or the precompensated conductivity is out of the range, the temperature compensation error (warning) will be issued. This is not a device error.

For more details, see “■ Temperature compensation error” on App. 3-8.

Any two of these three methods can be set for conductivity measurement as “Temp.comp.1” and “Temp.comp.2”. The result of either method can be output or displayed (see “10.2 Output setup” or “10.6 Display setup”).

When “Measurement” is set to “Conduct. + Concentr.” for the Measurement, only one method can be set.

## **NOTE**

The temperature compensation is not performed around zero. In this case, a warning may be issued.

### **10.1.5 Calibration settings**

The screen flow differs depending on the combination of objects to be measured.

- **Air adjust limit**

Generally, air calibration is not required. To avoid the effects of the cable on the measurement of lower conductivities such as pure water, a “zero” calibration with a dry sensor may be done.

Perform a zero-calibration using a dry sensor to prevent the cable from affecting the measurement. If a terminal box (BA20) and extension cable (WF10) are used, perform the zero-calibration while they are connected.

As the calibration is performed in air, the resistivity is infinite (open connection). Higher conductivity values than the air adjust limit indicate that the cell is not in air or is still wet. To prevent wrong air calibrations, a limit must be given here.

**NOTE**

---

Perform a zero check for air calibration while the temperature compensation is set to NaCl.

---

- **c.c. high**

High limit of the cell constant expressed as a % of the nominal value. During calibration this value is used to check if the calibrated cell constant remains within reasonable limits.

- **c.c. low**

Low limit of the cell constant expressed as a % of the nominal value. During calibration this value is used to check if the calibrated cell constant remains within reasonable limits.

- **Step Range**

Set the range over which the stability of a measured value is checked. If variations of a measured value over the stabilization time are within this set value, the measured value is judged to have stabilized.

- **Stabilization time**

During calibration, the stability of the measurement is constantly monitored. When variations of the value are within a value set in Step Range over this stabilization time set here, the value is regarded as being stable. If the value does not stabilize within 10 minutes, calibration is aborted.

- **Calibration interval**

Set the interval in which a new calibration must take place. If the interval set here is exceeded, the instrument will be notified according to the setting in “Calib. time exceeded” in the error configuration.

## 10.1.6 Concentration

The “Concentration” can be set only when “Conduct. + Concentr.” or “Concentration” is selected for the Measurement in the Measurement setup menu.

The corresponding concentration given by a measured conductivity can be shown on the Main display.

- **Concentration table**

Concentration can be calculated by using the temperature compensation matrix or the additional concentration table.

- **By using the temperature compensation matrix**

Set the “Additional table” to “Disabled”. The concentration can be obtained from the temperature compensation matrix (based on the relation between the conductivity at the reference temperature and the concentration).

Select Temp. compensation → Method, and then select Matrix. Next, choose a solution or User defined 1 or 2 (see Section 10.1.4). The concentration cannot be obtained by any other temperature compensation method (TC or NaCl).

- **By using the additional concentration table**

The additional concentration table indicates the relation between the conductivity and the concentration at the reference temperature. Set the “Additional table” to “Enabled”. The concentration can be obtained from the additional concentration table.

After entering values, select “Yes” for “Check values?”. Values are interpolated into empty cells. If any mandatory cells are left blank, an error will be issued. An error message is also issued if there is any error in the concentration table.

After completing entering values in the additional concentration table, set “Additional table” to “Enabled”.



- **Unit for table**

Select the concentration display units from among %, ppt, ppm, and ppb. Changing the unit will not result in a re-calculation of the table. Reenter values in the additional concentration table.

### 10.1.7 Sensor diagnostic settings

This screen is used to set items relating to sensor diagnostics displayed on the screens invoked

by pressing .

Gauges are displayed for only parameters that have been enabled in “Sensor diag. settings.”

Parameters set to Disable are provided with a bar display.

The setting parameters include Progress time and Heat cycle. It is also possible to set the “Bad limits” of the progress time and heat cycle and the “Heat cycle temp” and “Heat cycle time” of the heat cycle.

## 10.2 Output setup

The general procedure is to first define the function of the output, Output or Simulate. Then, set the process parameters associated with the output. On the Output, an output of measured value is selected. On the Simulate, a simulation value can be set.

And, the parameters for HOLD function can be set on this setting.

- **Output**

The output signal is a current value specified by the following parameters.

**Process parameter**

Available process parameters depend on the selected “Measurement” item in Measurement setup. Refer to Table 10.2.

The output of the selected process parameter is shown as a bar on the bottom of the Main display. And its parameter symbol (for example, Conduct1-TC1) is shown above the bar, too. When a selected process parameter is displayed as a measurement value, the top left number or character is turned to be white number or character on black background (for example, **1**). (Refer to the section 1.2.)

**Table 10.2 List of Process Parameters**

Sensor	Measurement	Process Parameters
1	Conductivity	Conduct1-TC1
		Temperature1
		Conduct1-TC2
	Concentration	Conduct1-TC1
		Temperature1
		Concent1-TC2
	Conduct. + Concentr.	Conduct1-TC1
		Temperature1
		Concent1-TC2

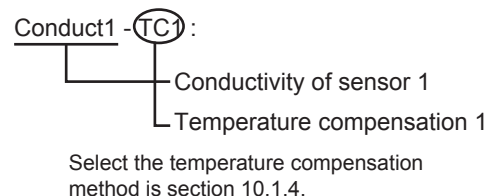

**Setup**

Select one of the output methods: Linear and Table.

Linear: Set the 0% and 100% values.

Table: This allows the configuration of an output curve by 21 points (5% intervals). (The 0% and 100% values must be entered.)

**Burn**

Select the designated output in case of a fault from among Off, Low, and High. See “10.3 Error configuration” to set the output.

Off: Output depends on the measured value.

Low: Output is fixed to 3.6 mA (when None is set in Communication setup)

Output is fixed to 3.9 mA (when HART or PH201G is selected in Communication setup)

High: Output is fixed to 22.0 mA.

**Damping time**

This is the time taken for a response to a step input change to reach 90% of the final value (attenuation time). Set this time in sec.

10

● **Simulate**

When this function is selected, an output of the instrument will be a fixed current value set in % of the output span. The output span range is -2.5% to 112.5% (3.6 mA to 22.0 mA).

When “Simulate” is selected, regardless of hold setting, the output is always simulated value.

■ **Configure Hold**

On the Configure Hold, settings are performed to hold of the mA output at a preset value. (Refer to the section 11.7.) This is enabled only if “mA” is “Output.”

During the Commissioning or the Quick Setup, the mA output is automatically held. The preset value depends on a setting on the “Last or fixed”.

“Last”: The preset value is a value measured just before hold condition.

“Fixed”: The preset value is a value set in the “Fixed value mA”.

When the “Fixed” is selected, set a mA value in the “Fixed value mA”.

Selection on the “Hold during Calibration” decides to activate or deactivate the hold function automatically during calibration.

“Enabled”: Activation of the automatic hold function

“Disabled”: No automatic hold function

## 10.3 Error configuration

In Error configuration, configure the statuses of various error causes.

This allows the system to notify the user of the occurrence of an error according to the status categories in the Error configuration.

Select a status category from among Off, Warn. (Warning), and Fault.

“Fault” automatically performs burn-out. When Burn has been set to Off (10.2 Output setup), only the error message is displayed.

“Warn.” displays an error message.

When selecting PH201G in the communication setting, make sure that the “Fail contact” setting is appropriate.

The settable causes of errors are determined based on the settings of the Sensor setup and Measurement setup, and a status category is set to the causes displayed in the Errors 1/3 to 3/3 screens.

ISC

**Table 10.3** Error configuration

Display item	Description	Default
Conductivity too high (or Concentration)	Conductivity or resistivity is lower than the minimum limit.	Warn.
Conductivity too low (or Concentration)	Conductivity or resistivity is higher than the maximum limit.	Warn.
Temperature too high	Measured process temperature is higher than the maximum limit.	Warn.
Temperature too low	Measured process temperature is lower than the minimum limit.	Warn.
Calibr. time exceeded	Calibration time exceeds the calibration interval (see Section 10.1.5).	Off
Configuration error: 1st comp. matrix 2nd comp. matrix	The temperature compensation matrix is not defined properly (see Section 10.1.4).	Fault
Concentration table	The concentration table is not defined properly (see Section 10.1.6).	Fault

**CAUTION**

If canceling an error configuration could be risky, do not cancel it as a dangerous situation may result.

**NOTE**

Use not Conductivity but (Conductivity x cell constant) to set the error limit for “Conductivity too high” and “Conductivity too low.”

**NOTE**

The temperature compensation is not performed around zero. In this case, a warning may be issued.

## 10.4 Logbook configuration

In “Logbook configuration,” the user configures information to be saved to a logbook or initializes the logbooks.

Logbooks are used to keep an electronic record of events such as error messages, calibrations, and programmed data changes. By referring to this log, users can, for instance, easily determine maintenance or replacement schedules.

In “Logbook configuration,” the user can select “Off,” “1-1,” or “1-2” for each item of interest to be logged. This can be done for items displayed on the Settings logbook 1/3 to 3/3 screens. Assigning 1-1 or 1-2 to each item allows information to be organized and logged in a logbook.

**NOTE**

Some events such as power-on are saved into the logbook “1-1”. This logbook may be full earlier. It is recommended that important information be saved into the logbook “1-2”.

For “Erase logbook”, a specified logbook “1-1” or “1-2” can be erased individually.

When the “Warn if logbook full” is set to “Yes”, a warning is given when the logbook come to near full (maximum 13 pages).

**NOTE**

When the logbook gets full, the oldest information is erased automatically.

## 10.5 Advanced setup

Advanced setup is used to set functions relating to matters other than measurements such as the selection of settings, tag setting, password setting for protecting calibration and commissioning operations, date setting, and communication setting.

(“Factory setup” is for service engineers only; there is no item to be set by the user.)

### 10.5.1 Settings

In “Settings,” select an item to be set as the default value from among “No action,” “Load factory settings,” “Save user settings,” and “Load user settings.”

When the default values are loaded, the instrument will be restarted. (In the case of “Save user settings,” it will not be restarted.)

The following parameters are not included in the defaults:

- Tag
- The contents of all logbooks

#### NOTE

When the “Save user setting” is only selected, save of the user-set parameters will start at once.



To avoid wrong selection, operation in this Settings must be done by , not by touching the menu message.

If you select “Load factory settings,” the instrument will be set to the default settings at factory shipment.

When this item is selected, a screen prompting whether to restart is displayed. If this is no problem, press “Yes.” Then the “Loading ...” message appears and blinks and loading is started. When the factory settings have been loaded, the instrument will be restarted.

When “Save user settings” is selected, the current settings can be saved as the defaults.

When this item is selected, the user settings will start to be saved immediately. After saving the

parameters, press  or  to change the display because this save doesn't have restart function.

If “Load user settings” is selected, the settings saved as user settings can be set as the defaults.

When this item is selected, a screen prompting whether to restart is displayed. If this is no problem, press “Yes.” Then the “Loading ...” message appears and blinks and loading is started. When the user settings have been loaded, the instrument will be restarted.

### 10.5.2 Tag

A tag provides a symbolic reference to an instrument and is generally defined to be unique throughout the control system at one plant site. A tag can contain up to 12 alphanumeric characters. The default value is ISC or FLXA21-ISC.

The tag is displayed at the top of the main display.

### 10.5.3 Passwords

Calibration and commissioning operations can be separately protected by each password. To protect execute operations, enter a password in Execute's input field. To protect commissioning operations, enter a password in Commissioning's input field. By default, both input fields are empty. When a password input field is empty, operation is not password-protected. A password can contain up to 8 characters.

When you set a password, always take a note of it.

When a password is set, input of the password is necessary to enter the password-protected operation. After inputting the password, the display will change to an operator ID input display. When an operator ID is input, its operation is recorded into a logbook. The input of an operator ID is not necessary to enter the operation. An operator ID can contain up to 4 characters.

### 10.5.4 Date/Time

The Logbooks and trend graphs use the clock/calendar as a reference. The current date and time is set here. The time display format can be selected from among three types.

### 10.5.5 Communication

Select a communication parameter from None, HART, or PH201G in Communication setup. The burn down current is 3.9 mA when HART or PH201G is selected, and 3.6 mA when None is selected.

#### NOTE

---

To make the change of "Communication" valid, turn off the power supply once, and reboot.

---

In the case of "None," there is not the problem even if you do not change it as "HART" of default value except that the burn down current is different.

#### ■ HART

Select this menu when HART communication (HART 5) is made.

In the HART setup screen, specify the network address and set up parameters for SV, TV, and FV. (PV is linked with the "process parameter" setting in "Output settings" and cannot be changed here.)

- **Network address**

For 1-to-1 communication, leave the default value [0] unchanged. For multi-drop where multiple HART devices are connected on a bus, set addresses in 1 to 15. In this case, the mA output will be fixed to 4 mA.

- **PV**

PV is a parameter selected for analog output; it cannot be changed here.

- **SV, TV, FV**

The SV, TV, and FV parameters are items that the user must set up. Selectable items differ depending on the sensor type in "Sensor setup" and settings in "Measurement setup."

If blank is selected for a parameter, items below that parameter must all be set to blank. If an item is blank, those below it cannot be set to a status other than blank.

For more information on HART communication, see the Technical Information (TI 12A01A02-60E) in the attached CD-ROM.

## ■ PH201G

Select this menu if the PH201G distributor is connected to the instrument.

In the PH201G setup screen, make settings for “Hold contact,” and “Fail contact.”

### ● Hold contact

Select Disabled or Enabled.

When this item is enabled, the output will be held according to the setting of “Hold type” on the Hold setup screen.

### ● Fail contact

Select a status from among “Fail + Warn,” “Fail only,” and “Disabled.”

This setting depends on the error configuration. See “10.3 Error configuration.”

“Fail” corresponds to “Fault.”

10

## 10.5.6 Factory setup

For “Factory setup,” there is no item to be set by the user.

### NOTE

---

This menu is for service engineers only. This section is protected by a password. Attempting to change data in the factory adjustment menu without the proper instructions and equipment could result in corruption of the instrument setup and damage the performance of the unit.

---

## 10.6 Display setup

This screen is used to make various settings relating to screen display.

### NOTE

---

Settable items differ depending on settings in “Measurement setup.”

---

### 10.6.1 Main display

Three measurement values can be set to display on the Main display as a primary value (1st line), a second value (2nd line) and a third value (3rd line) respectively.

On the “Additional text”, a text of up to 12 alphanumeric characters can be assigned to each measurement value.

Additional texts are displayed on the Main display, and are useful for identifying measurements. In some cases, not all 12 characters can be displayed due to the letters; check the texts displayed on the Main display after setting. If a part of the text is missing, adjust the number of characters.

### 10.6.2 Trend

This screen is used to make settings for the Trend Graph Screen.

Set the process parameters to be displayed for each trend. They can be set for the 1st to 3rd trends. When all three process parameters are set “Empty”, there is no trend display (no trend button).

ISC

- **X-axis: Timing**

Select the X-axis timing's time span on the trend graph display from a list.

- **Y-axis: Limits**

Set the Y-axis high and low limits on the trend graph display on a Trend screen basis.

### **NOTE**

---

Updating the trend display setup resets the current trend graph and starts a new one.

---

## **10.6.3 Auto Return**

When no operation is performed for the time set in "Auto Return", the display returns to the Monitor display (or to the Main display when the MONITOR display is disabled) and the analyzer returns to a normal measuring mode. (When the Trend display is selected, the Auto Return doesn't work.)

Select the time from among Disable, 10 min, and 60 min. When the Auto Return function is not used, select "Disable."

### **NOTE**

---

A default is "10 min". When maintenance like a calibration that may take much time is performed, "60 min" or "Disable" is recommended to be selected.

---

## **10.6.4 Adjust contrast**

The LCD screen contrast can be adjusted.

Pressing the ▲ ▼ keys adjusts the contrast in 11 levels from +5 to -5 (including the default value of "0").

## **10.6.5 MONITOR display**

Select "Enable" so that the Monitor display becomes available. A default is "Enable".

During Hold condition and a warning/fault condition, the Main display is displayed to indicate the condition.

# 11. CALIBRATION OF ISC (Inductive Conductivity)

Inductive conductivity meters must be calibrated after being installed in a measurement location or moved to a different location.

Inductive conductivity meters do not generally need to be calibrated repetitively if they have been calibrated once before the start of use. If the cell is severely contaminated or has been subject to abrasion (possibly during cleaning), calibration may be necessary.

Execute air calibration first, if needed.

When using solutions, manual, automatic, and sample calibrations are available.

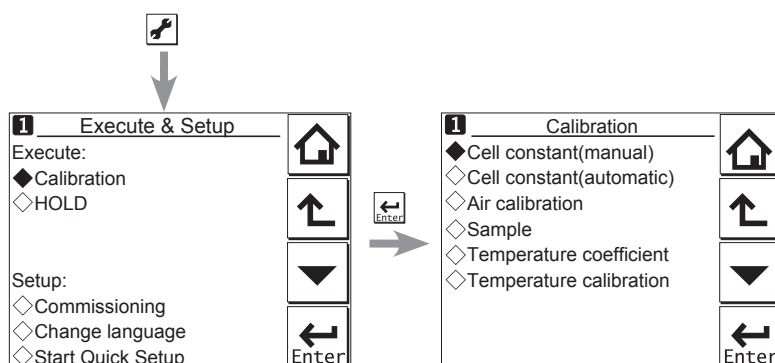

Figure 11.1 Calibration

## NOTE

A default is “10 min” for “Auto Return”. When maintenance like a calibration that may take much time is performed, “60 min” or “Disable” is recommended to be selected. (Refer to the section 10.6.3.)

Calibration is carried out by measuring a solution which has a known conductivity and adjusting the instrument to show the correct conductivity value.

- **“Cell constant (manual)”, “Cell constant (automatic)”**

A calibration solution can be prepared in the laboratory. A salt solution is prepared with a known precise concentration. The temperature is stabilized to the reference temperature of the instrument (usually 25°C). The actual conductivity of the solution is taken from literature data. The typical calibration solutions include NaCl and KCl; see Appendix 3. To calibrate the instrument, the sensor is removed from a process and suspended in the solution, the conductivity value from the literature data is then entered and the calibration routine completed.

Make sure the sensor does not touch the sides of the container (see Figure 11.2).

- **“Sample calibration”**

This calibration uses a process solution. In this method, the conductivity of the process solution under measurement is measured with a standard instrument. In this case, care must be taken to make the measurement at the reference temperature since differences in the type of temperature compensation of the instruments may cause an error. With this method, it is not necessary to remove the sensor from the process. Because the sensor is immersed in the process, errors caused by the installation characteristics are compensated for.



**NOTE**

The standard instrument to be used in calibration with a process solution should always be accurate. Yokogawa recommends that the Model SC72 pocket conductivity meter be used for this purpose.

Where temperature compensation 1 (SC1) and temperature compensation 2 (SC2) have been configured, the configured temperature compensation is effective even during calibration. Therefore, the reading is the value converted to a conductivity value at the reference temperature set in Temperature settings.

There are temperature compensation 1 (SC1) and temperature compensation 2 (SC2), but this does not mean that calibration is required twice. It means that either SC1 or SC2 temperature compensation should be selected and calibration should be made once to obtain the cell constant. The cell constant after calibration can be checked on the Detail screen.

**NOTE**

When a sensor is exchanged or replaced, sensor wellness data should be reset.

When a sensor is replaced, the replacement can be recorded manually into a logbook. (Refer to the figure 9.8.)

### ● Cell constant

The center value of the cell constant of the ISC40 sensor is  $1.88 \text{ cm}^{-1}$ . The nominal cell constants of individual sensors are indicated on the cable markers and the actual installation can change this factor. If there is less than 30 mm spacing between a sensor and holder, in-situ calibration is necessary to meet the specified accuracies.

- If the sensor is installed in the stainless steel standard holder ISC40FFJ-S, the cell constant is reduced by approximately 7%; enter a value 7% smaller than the value on the marker of the sensor cable.
- If the sensor is installed in the polypropylene standard holder ISC40FFJ-P, the cell constant is increased by approximately 1%; enter a value 1% greater than the value on the sensor cable marker.
- If the sensor is installed in piping that is long in the axial direction with the cross section as shown in Figure 11.3, the cell constant of the sensor installed in the piping (reference data for a design center value of  $1.88 \text{ cm}^{-1}$ ) is as shown in Figure 11.3. A value obtained by multiplying the value on the sensor cable marker and a value read from Figure 11.3 should be entered.

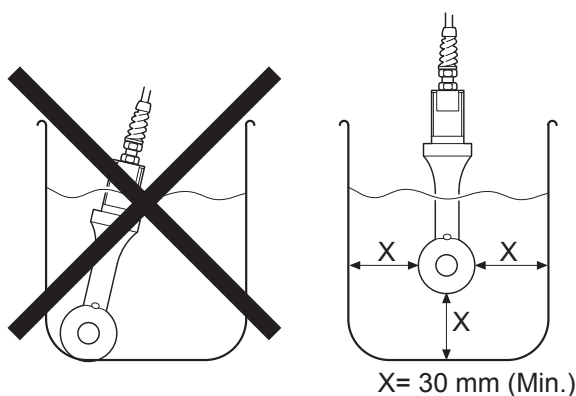

Figure 11.2 Sensor in calibration solution

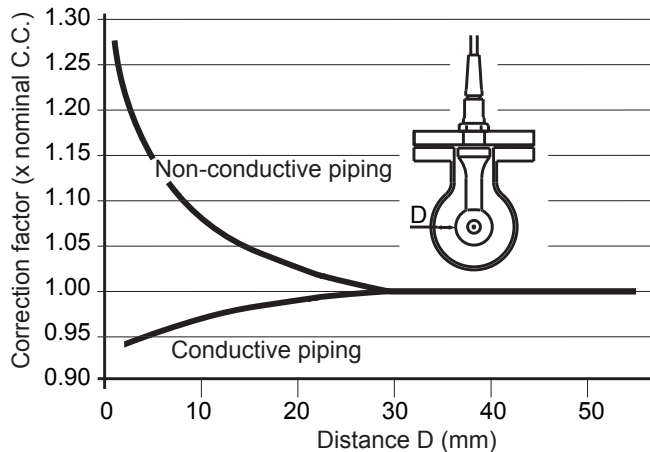

Figure 11.3 Relationship between the distance from the sensor to side wall and the cell constant

## 11.1 Cell constant (manual)

The intention of this calibration routine is to fine-tune a sensor for which only the nominal cell constant is known, or to recalibrate a sensor that has been changed (or damaged) during operation. Choose the 1st or 2nd temperature compensation to suit the calibration solution used. The solution with an appropriate precision should be prepared or purchased. Allow the sensor to reach stable readings for both temperature and conductivity before adjusting to the value of the corresponding calibration solution.

The cell constant of the calibrated sensor should also be set up here.

## 11.2 Cell constant (automatic)

This routine is built around the test method described in International Recommendation No. 56 of OIML (Organisation Internationale de Metrologie Legale). It allows the direct use of the solutions prescribed in the test method, automatically selecting the appropriate temperature compensation. The look-up table is used to find an appropriate conductivity reading for the measured temperature. See Appendix 3 for OIML solutions.

## 11.3 Air calibration

Execute air calibration first, if needed.

With the clean dry cell in open air, the reading should be zero. The air cal compensates for excess cable capacitance, and gives a better accuracy at low readings. This should be done when a sensor is installed or replaced. After some time in service, a dirty sensor may well show a high zero offset because of fouling. Clean the sensor and try again. Moreover, air calibration should be made in an environment free of electromagnetic interference.

Wait for the sensor to dry because air cal must be made with no current flow in the sensor, that is, the sensor must be dried while being exposed to air.

---

**NOTE**

The temperature compensation should be set to NaCl when confirming zero during air calibration.

---

---

**NOTE**

The temperature compensation is not performed around zero. In this case, a warning may be issued.

---

Not being wet, the sensor measures the conductivity of air, which is close to zero. Because zero conductivity is out of the range for temperature compensation (this range is based on the temperature and conductivity of solutions and is preset to 0.033  $\mu\text{S}/\text{cm}$  at 20°C), a warning may be issued. This is not a device error.

The conductivity of air is zero and it does not have a temperature coefficient. Execute zero calibration regardless of the warning.

## 11.4 Sample

With the sensor in situ, a sample can be taken for laboratory analysis. Sample calibration records the time and reading, and holds these in memory until the analysis has been completed. The laboratory data can then be entered regardless of the current process value, without the need for calculations.

When sample calibration is made with temperature compensation activated, the types of temperature compensation for laboratory analysis equipment should be matched. Use of a different type of temperature compensation between equipment causes an error. The standard conductivity meter to be used should always be based on the accurate and same temperature compensation calculation method. Yokogawa recommends that the Model SC82 pocket conductivity meter be used for this purpose.

Press [Take Sample] to record a collected sample value in memory. Re-enter the Sample Cal. screen and press [Start calibration] to perform a sample calibration. This updates the recorded data.

## 11.5 Temperature coefficient

Simply input the solution conductivity at the reference temperature (TR) after allowing the sensor to stabilize at elevated temperatures. The FLXA202/FLXA21 will calculate the temperature coefficient for you. The ideal temperature for this calibration is the normal process value (TP). This calibration is enabled if the Temperature Compensation is set to "TC." (Refer to section 10.1.4)

## 11.6 Temperature calibration

In order to make the most accurate measurements, it is important to have a precise temperature measurement. This affects the display of temperature, and the output signal (when used). More important, however, is the temperature compensation, and calibration accuracy. The temperature of the sensor system should be measured independently with a high precision thermometer. The value of “Measured temperature” should then be adjusted to agree with the reading (zero offset calibration only). For best accuracy, this should be done as near to the normal operating temperature as possible.

## 11.7 HOLD

The FLXA202/FLXA21 has a function to hold the mA output at a preset value (default: “Last”). Use this menu to hold the output.

For the settings, see “■ Configure Hold” on page 10-7.

During commissioning or quick setup, the output is automatically held.

Setting “Hold during Calibration” to “Disabled” deactivates the hold function during calibration.

Press  to select Execute: HOLD and then choose Manual Hold ON or Manual Hold OFF. This allows you to set up manual hold.

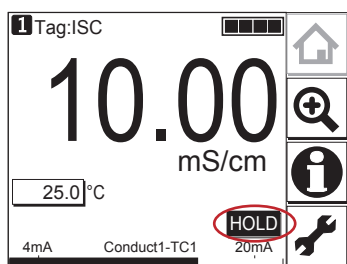

**Figure 11.4** Example of the display with the manual hold enabled

To cancel manual hold, press the lit  section on the Main display.



# 12. OPERATION OF DO (Dissolved Oxygen)

This chapter describes the screen operations of DO, the object to be measured.

Further details of screen operations can also be found in section 1.2.

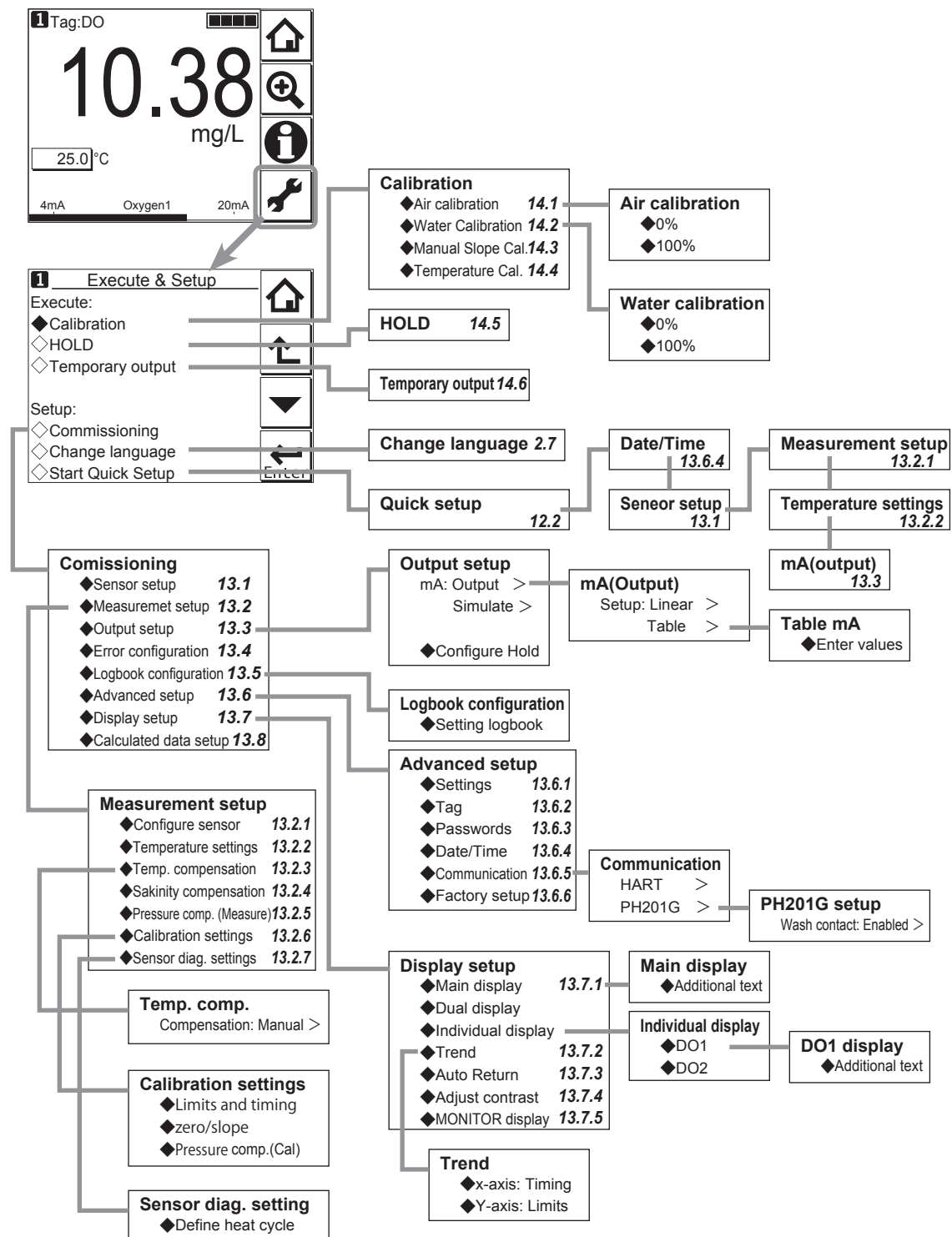

Figure 12.1 Menu structure of DO (the number after the item refers to the relevant section)

12

DO

---

## 12.1 Change language

The screen is set to display English at factory shipment; if you wish to use the FLXA202/FLXA21 in another language, first select a language as described in section 2.7.

## 12.2 Quick setup

The Quick setup screen is used to set up the basic items you want to set up first, such as the date/time and sensor settings. The detailed settings are described in chapter 14, Commissioning.

You may leave the Quick setup now and return to it later; however, it is recommended to perform the quick setup first.

Each time the FLXA202/FLXA21 is started up, this screen is displayed. If it is not necessary to

change the setup, press No or .

### NOTE

---

When no operation is performed for 10 minutes or 60 minutes (depending on the setting of “Auto Return”), the display except Trend display automatically changes to the Monitor display (or to the Main display or the Home display when the MONITOR display is disabled).

---

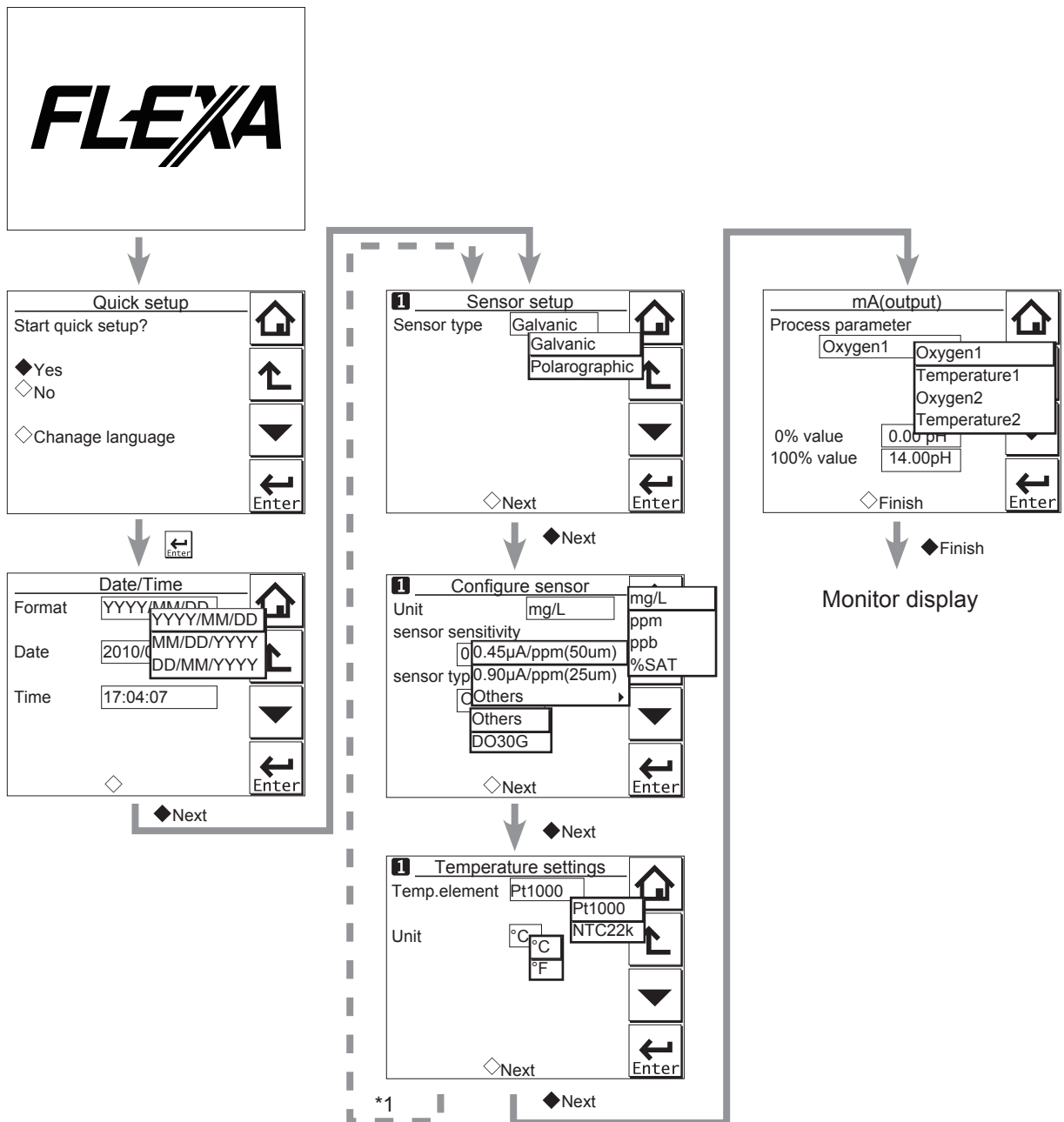

\*1: If two sensors are connected, the second sensor can also be set up.

Figure 12.2 Quick setup

### ■ Date/Time

The date display format can be selected from among the three types.

Enter the date or time of day by using the numerical keys.

For details, see section 13.6.4.

### ■ Sensor setup

Select a suitable electrode from among the displayed electrode types and set it up.

For details, see section 13.1.



■ **Configure sensor**

On this screen, select the units and set the sensor sensitivity. If Polarograph is selected for the sensor type, the polarograph application voltage can also be set. For details, see section 13.2.1. For DO30G, set the sensor type to "DO30G". The Available KOH parameter on the detail display will be enabled.

■ **Temperature settings**

Select a suitable temperature element from among those displayed and set it up. Celsius (°C) or Fahrenheit (°F) temperature scale can be selected. For details, see section 13.2.2.

■ **mA (output)**

Select an appropriate process parameter from among those displayed and set it. If it is necessary to improve the resolution, set it to a value suitable for the relevant process. For details, see section 13.3.

## 12.3 Home display, Main display and Monitor display

Pressing  changes the screen to the Main display shown in Figure 12.3 (or the Home display shown in Figure 12.4).

If two sensors are connected, pressing  on the Main display changes the display to the Home display shown in Figure 12.4.

If only one sensor is connected,  is grayed out and disabled on the Main display.

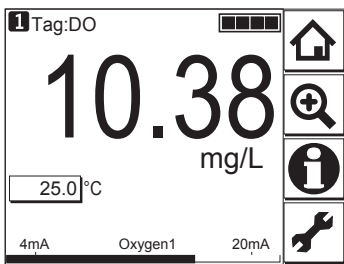

Figure 12.3 Example of main display

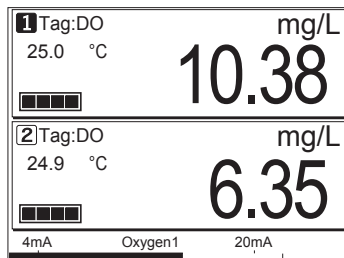



Figure 12.4 Example of home display

On the Home display, pressing  of the 1st sensor (top) or 2nd sensor (bottom) causes the display of the selected sensor to appear on the Main display.

On the Main display, pressing  of the 2nd or 3rd display item causes the 1st display item to be replaced by the selected item.

**NOTE**

Measured values to be displayed in the 1st to 3rd display items depend on the user definition (see section 13.7.1). In the default condition, the 1st display item is oxygen, the 2nd display item is temperature, and the 3rd display item is empty.

When the MONITOR display is enabled (see section 13.7.5), pressing the 1st display item on the home display or the main display changes the display to the Monitor display with the enlarged font of the measured value.

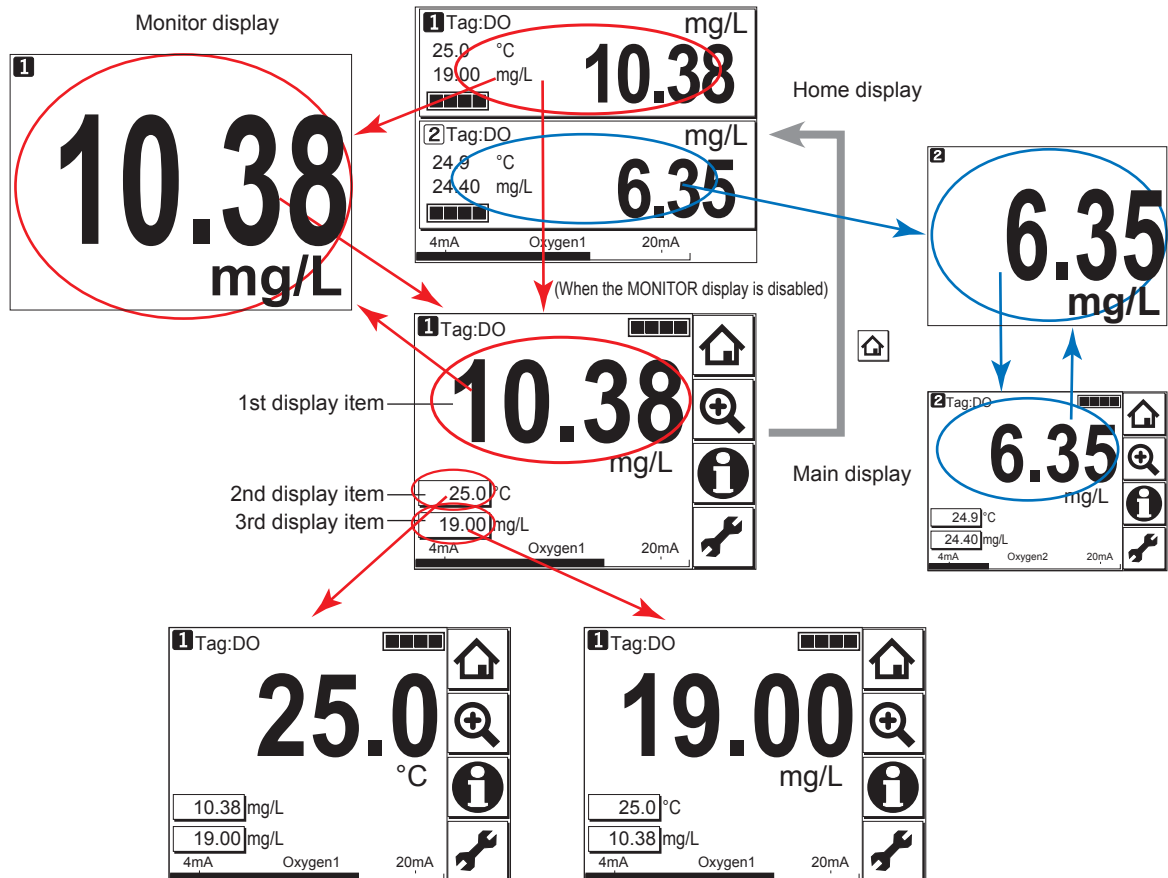

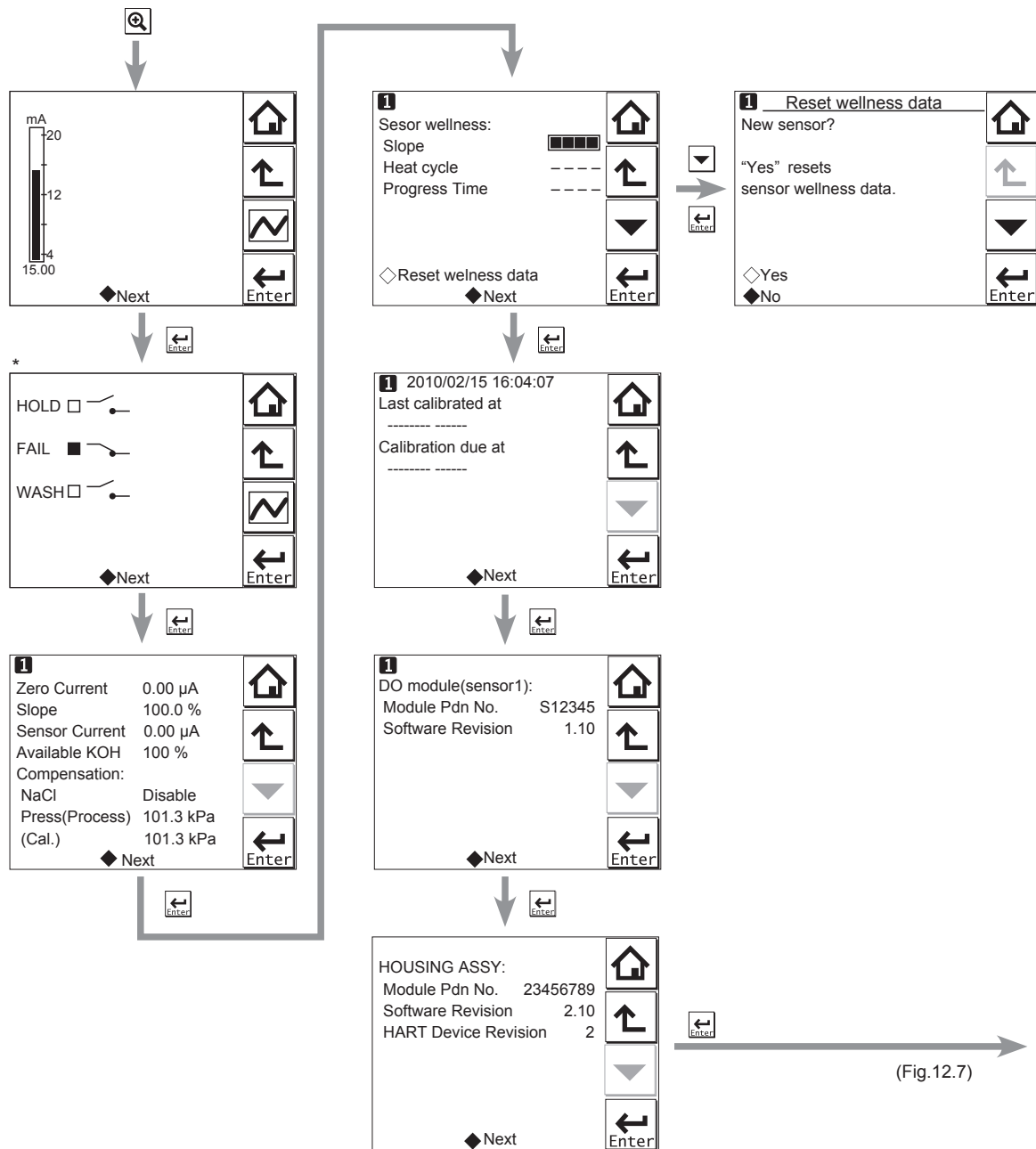

Figure 12.5 Change display

## 12.4 Zooming in on details

Pressing  on the Main display allows you to check detailed instrument information (instrument information such as setup, sensor diagnosis, calibration, and module productions number) through a transition of screens as shown in Figure 12.6.

In case of trouble, when you contact your nearest Yokogawa service center, please inform us of the module and FLXA202/FLXA21 software revision displayed on the Detail screen and other display information as well as the module productions number indicated on the nameplate attached to the instrument.



\*: This screen is displayed only if the PH201G distributor is used and “PH201G” is selected in communication setup.

Figure 12.6 Detail display

### ■ Current output mA

= current output in mA. The range and function of this mA output can be set in Commissioning → Output setup → mA.

For details, see section 13.3.

### ■ Contact status

This screen is displayed only if the PH201G distributor is used and “PH201G” is selected in communication setup.

## ■ Zero Current

= The offset value of a calibrated sensor. This is the offset of the sensor and sensor circuit in the zero oxygen condition.

## ■ Slope

This parameter indicates the sensitivity of the sensor after calibration. It is indicated as a percentage of the reference sensitivity based on the selection of the sensor or that has been entered.

## ■ Sensor Current

= The raw output of the sensor before it is calibrated and temperature compensated.

## ■ Available KOH

When the sensor type under Configure sensor is set to "DO30G", a number is displayed. When set to "Others", a bar (----) is displayed.

This parameter indicates the amount of available KOH remaining in the sensor. This amount is calculated and displayed by totalizing the amount of KOH consumed by dissolved oxygen measurements.

When replacing the solution in the sensor, calibration should be made to reset (clear) diagnostic sensor data.

## ■ Compensation

For compensation of measured value, salinity compensation and pressure compensation are available. To use pressure compensation, enter the pressure level directly.

## ■ Sensor wellness

At the Sensor wellness window, the soundness of a module is displayed. A larger number of ■ in each gauge indicates that the parameter concerned is sound. A gauge is indicated for only those parameters whose sensor wellness setting is "enabled," while a bar (----) is displayed if the sensor wellness setting is "disabled."

Sensor wellness setup can be made in Commissioning → Measurement setup → Sensor diag. settings. For details, see section 13.2.7.

The "Reset wellness data" button can reset wellness data.

When a sensor or a membrane is exchanged or replaced, sensor wellness data should be reset.

## NOTE

When a sensor is replaced, the replacement can be recorded manually into a logbook. (Refer to the figure 12.7.)

## ■ Last calibrated

= date on which the last sensor calibration was performed. The displayed value of the Zero is the result of this calibration. The displayed value of Slope was calibrated on this date only if the last calibration was a 2-point calibration.

## ■ Calibration due

= the date when the calibration must be done next according to the settings of the calibration interval. The calibration intervals are set in Commissioning → Measurement setup → Calibration settings → Limits and timing.

### ■ DO module (sensor)

With this screen, you can check the module productions number and software revision of the installed module.

### ■ HOUSING ASSY

With this screen, you can check the module productions number, software revision, and HART device revision of the housing assembly.

### ■ Read logbook

The FLXA202/FLXA21 has two types of logbook per sensor to store history information on events, such as changed settings and calibrations.

By selecting one of the logbooks that you wish to check, you can retrieve and check this information. Storage of history information on each event in a logbook or which logbook to use for storage can be set up on the Configure logbook screen. For details, see section 13.5.

History information on events are automatically stored on the preset conditions.

In addition to this storing, following three messages can be manually stored in the logbook;

"Sensor washed by hand", "Module replaced", "Sensor replaced"

To store these messages, press  and select one of three messages from the Item on the Memorandum screen. Its event date/time will be the time when a message is selected and entered.

When a password for Commissioning is set on the passwords' setup, pressing  requires entering the password. (Refer to the section 13.6.3.)

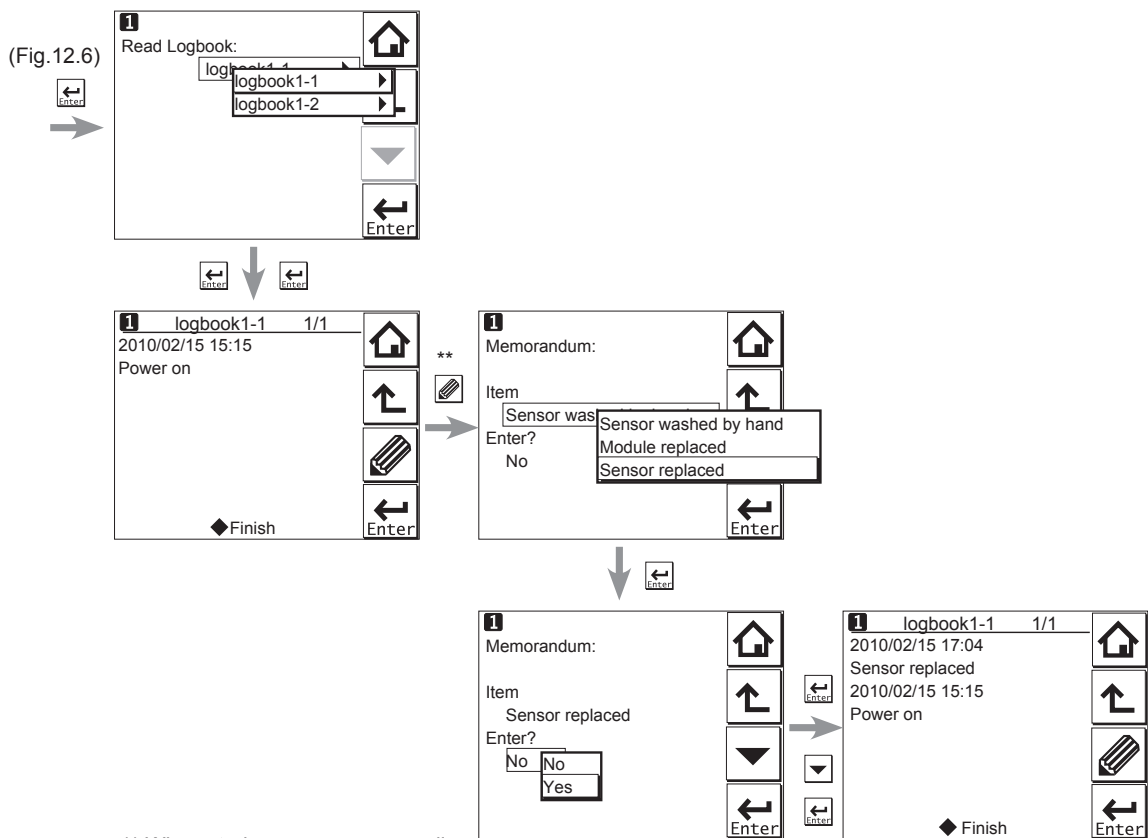



Figure 12.7 Detail display (continued)

## 12.5 Trend graphics

Pressing  on the Zoom display changes the display to a graphical mode in which the average measured value is shown on a time scale. The “Live” value is also digitally displayed in a text box. The time scale (X-axis) and the primary value scale (Y-axis) are set in the “DISPLAY SETUP” menu (Section 13.7.2).

The screen displays the trend of up to 41 averages of the measurement for each time interval. The FLXA202/FLXA21 samples the measurements every second. The trending graphic also shows the maximum and minimum measured values in that interval.

For example, if the time scale is set to 4 hours, then the trend is shown for 4 hours prior to the actual measurement. Each point on the trend line represents the average over  $4 \times 60 \times 60 / 41 = 351$  measurements (seconds).

### NOTE

Updating the trend screen setup resets the current trend graph and starts a new one.

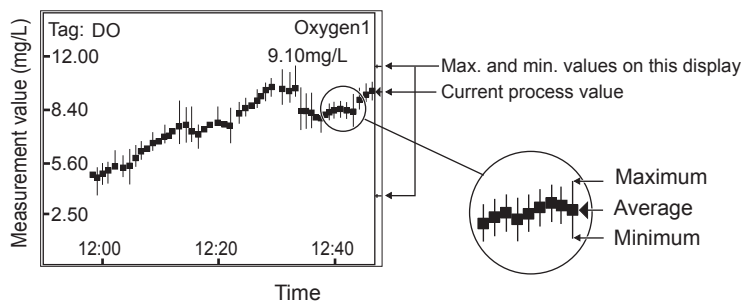

Figure 12.8 Trend screen

The 1st display item data on the Main display is shown as a graph. Touching any point on the display changes the display to the 2nd display item data (and to the 3rd display item data if set) and then returns to the Main display.

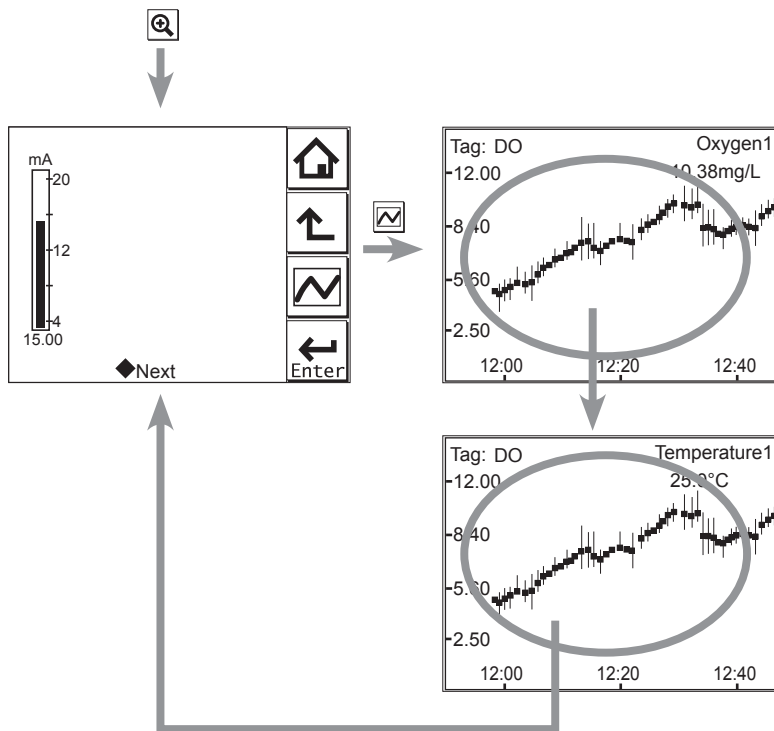

Figure 12.9 Trend graphics

## 12.6 Instrument status screen

In the  field of the Main display, the  (Warning) or  (Fault) sign appears according to the instrument status. Upon pressing the displayed button, detailed information of the relevant status appears.

See “■ Information button” on page 1-10.

## 12.7 Calibration and Commissioning

Allows you to calibrate and configure the instrument. These operations can be protected with a password.

For details on the password, refer to section 13.6.3.

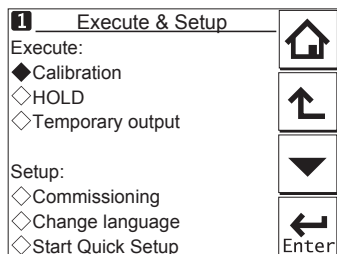





Figure 12.10 Execute & Setup

Pressing  changes the display to the Execute & Setup screen.

Browse through the menu items by pressing  until you find the desired menu and then press  to enter that menu. It is also possible to enter a desired menu by pressing the ◇ symbol beside the menu item.

For calibration (HOLD, Temporary output), read chapter 14, and for commissioning, read chapter 13.





# 13. COMMISSIONING OF DO (Dissolved Oxygen)

This chapter describes how to check and change settings from the Commissioning screen.

When you move to the Commissioning screen, the output is held.

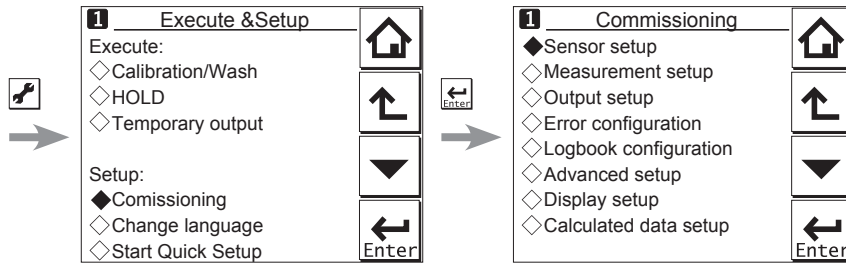

Figure 13.1 Example of the commissioning screen (for two modules)

Operations in Commissioning can be password-protected. If you set up a password, always take a note of it. For details on setting a password, see section 13.6.3.

Figure 12.1 shows the commissioning procedure. Before changing any parameters, read the relevant sections in this document and understand how the change of parameters affects the performance of this instrument. If you set a wrong value, return it to the default setting or value and then set it again.

On the first startup, the parameters are all default values configured at the factory. Check the parameters in Table 13.1 and change any of them if necessary depending on the sensors to be connected and the purpose of use.

Set "Sensor type" first. Some measurement parameters and relevant options change accordingly. The underlined parameters in Table 13.1 are used for the quick setup.

The default values and setting ranges are listed in the "User setting table of DO" in the attached CD-ROM.

After confirming that the instrument operates normally with the parameters, print out the "User setting table of DO" and write down these parameters in the column of User Settings.

All user parameters can also be saved in the instrument.

Select Commissioning → Advanced setup → Settings → Save user settings (see Section 13.6.1).

**Table 13.1** Menu Structure and Default Values in “Commissioning

Parameter		Ref. sect.			
Sensor setup	<u>Sensor type</u>	13.1			
Measurement setup	Configure sensor	<u>Unit</u>	13.2.1		
		<u>Sensor sensitivity</u>			
		Polarization Voltage			
	Temperature settings	<u>Temp. element</u>	13.2.2		
	Temp. compensation		13.2.3		
	Salinity compensation		13.2.4		
	Pressure comp. (Measure)		13.2.5		
	Calibration settings		13.2.6		
Sensor diag. settings		13.2.7			
Output setup	mA	Output	<u>Process parameter</u>	13.3	
			Setup		
			Linear		<u>0 % value</u>
					<u>100 % value</u>
			Table		
			Burn		
			Damping time		
			Simulate		Simulation perc.
			Configure Hold		
			Error configuration		
Logbook configuration		13.5			
Advanced setup	Settings		13.6.1		
	Tag		13.6.2		
	Passwords		13.6.3		
	Date/Time		13.6.4		
	Communication	HART		13.6.5	
		PH201G			
	Factory setup		13.6.6		
Display setup	Main display (Dual display, Individual display)		13.7.1		
	Trend		13.7.2		
	Auto Return		13.7.3		
	Adjust contrast		13.7.4		
	MONITOR display		13.7.5		
Calculated data setup	Function		13.8		

**NOTE**

All the parameters for the quick setup (underlined ones in Table 13.1) are crucial for measurement. If you change any of them, other parameters may be initialized. For the parameters that may initialize other values, see Appendix 4.

## 13.1 Sensor setup

Select the sensor type that is used from among “Galvanic” and “Polarographic.”

The sensor type suitable for the actually connected sensor should be selected.

## 13.2 Measurement setup

In this section, set up various parameters relating to measurements.

Measurements are performed based on the measurement parameter setup.

If "Polarographic" is selected for "Sensor type" in the Sensor setup screen, the polarographic application voltage can be set.

### 13.2.1 Sensor setup

Select a unit for sensors from mg/L, ppm, ppb, and %SAT. Select a value for sensor sensitivity from 0.45  $\mu\text{A/ppm}$  (50  $\mu\text{m}$ ), 0.90  $\mu\text{A/ppm}$  (25  $\mu\text{m}$ ), and other. If you select "other," enter an appropriate value.

### 13.2.2 Temperature settings

Select the temperature element used for compensation from among Pt1000 and NTC22k. Select the same type as the temperature element that is actually connected.

Celsius ( $^{\circ}\text{C}$ ) or Fahrenheit ( $^{\circ}\text{F}$ ) temperature units are available. If the unit is changed, the following values are also recalculated automatically to the new unit:

- Manual temp.
- Reference temp.
- Temp. coefficient
- Temp. ranges in the matrix

### 13.2.3 Temperature compensation

Select "Manual" or "Automatic" for the temperature compensation type.

Select "Automatic" if the temperature sensor's measured value is used or "Manual" if no temperature sensor is used.

#### NOTE

When Manual is selected on the Temperature compensation, a process temperature should be set in the "Manual temp." A temperature shown on the Main display or the Home display is this manually set temperature.

### 13.2.4 Salinity compensation

This function is used to measure sample water containing salt such as sea water.

The dissolved oxygen in a solution is affected by salinity. Therefore, to conduct accurate measurements, it is necessary to compensate the influence of the salinity of the sample solution. To make salinity compensation, select "Enabled" for "Compensation."

Calculate the saturated concentration value from the salinity and temperature of the actual sample water based on Table 1 of Appendix 4 (Solubility of oxygen in water as a function of temperature and salinity) and enter the value.

### 13.2.5 Pressure comp. (Measure)

Dissolved oxygen concentration changes depending on changes in the process pressure or air pressure. To compensate this, enter a value of pressure (air pressure).

See Tables 2 and 3 in the Appendix.

## 13.2.6 Calibration settings

In “Calibration settings,” set the high and low limits of Zero/Slope and set up parameters relating to stabilization performed during calibration.

- **Limits and timing**

- **Zero High/Low**

- Set the high and low limits of Zero. During calibration, it is checked whether the new zero exceeds these high and low limits. Narrowing the band will prevent bad calibration procedures and calibration of bad sensors, which results in higher accuracy. The default values should be adjusted to suit the application and the “users” criterion.

- **Slope High/Low**

- Set the high and low limits of Slope. During calibration, it is checked whether the new slope exceeds these high and low limits. Narrowing the band will prevent bad calibration procedures and calibration of bad sensors, which results in higher accuracy. The default values should be adjusted to suit the application and the “users” criterion.

- **Stabilization time**

- During calibration, the stability of the measurement is constantly monitored. When variations of the value are within a value set in Step Range over this stabilization time set here, the value is regarded as being stable. If the value does not stabilize within 60 minutes, calibration is aborted.

- **Step Range**

- Set the range over which the stability of a measured value is checked. If variations of a measured value over the stabilization time are within this set value, the measured value is judged to have stabilized.

- **Calibr. interval**

- Set the interval in which a new calibration must take place. If the interval set here is exceeded, the instrument will be notified according to the setting in “Calib. time exceeded” in the error configuration.

- **Zero/Slope**

- You can enter zero and slope values directly.

- Zero current values can be set only when the setting of “Zero Calibration” is “Enabled.”

- **Pressure comp. (Cal.)**

- You can enter the pressure level directly.

- **Zero Calibration**

- If zero calibration is required, select “Enabled” for this parameter. The default value is “Disabled.” When this feature is enabled, “Zero current values” can be set in zero settings.

### **NOTE**

---

When the zero calibration is set to “disabled” after performing the calibration, the result of the calibration turns invalid (default).

---

## 13.2.7 Sensor diag. settings

This screen is used to set items relating to sensor diagnostics displayed on the screens invoked

by pressing .

Gauges are displayed for only parameters that have been enabled in “Sensor diag. settings.”

Parameters set to Disable are provided with a bar display.

The setting parameters include Progress time and Heat cycle. It is also possible to set the “Bad limits” of the progress time and heat cycle and the “Heat cycle temp” and “Heat cycle time” of the heat cycle.

## 13.3 Output setup

The general procedure is to first define the function of the output, Output or Simulate. Then, set the process parameters associated with the output. On the Output, an output of measured value is selected. On the Simulate, a simulation value can be set.

And, the parameters for HOLD function can be set on this setting.

### ● Output

The output signal is a current value specified by the following parameters.

#### Process parameter

For the available process parameters, see Table 13.2.

The output of the selected process parameter is shown as a bar on the bottom of the Main display or the Home display. And its parameter symbol (for example, Oxygen1 or Diff-Oxygen1) is shown above the bar, too. When a selected process parameter is displayed as a measurement value, the top left number or character is turned to be white number or character on black background (for example, **1** or **R(1)**). (Refer to the section 1.2.)

**Table 13.2 List of Process Parameters**

Number of sensors	Process Parameters
1	Oxygen1 (2)
	Temperature1 (2)
2	Oxygen1
	Temperature1
	Oxygen2
	Temperature2
	Calculated*1
	Redundant*2

\*1: Refer to section 13.8, Calculated data setup.

\*2: Refer to the <Redundant system> below.

Calculated data and Redundant system are available when two modules are installed on the instrument.

#### <Redundant system>

On the Redundant system, when a sensor (Sensor 1) of the 1st module fails, the output is automatically switched to the output of the 2nd module.

After repairing the Sensor 1, manual reset of redundant system is necessary to return to the output of 1st module from the output of the 2nd module.

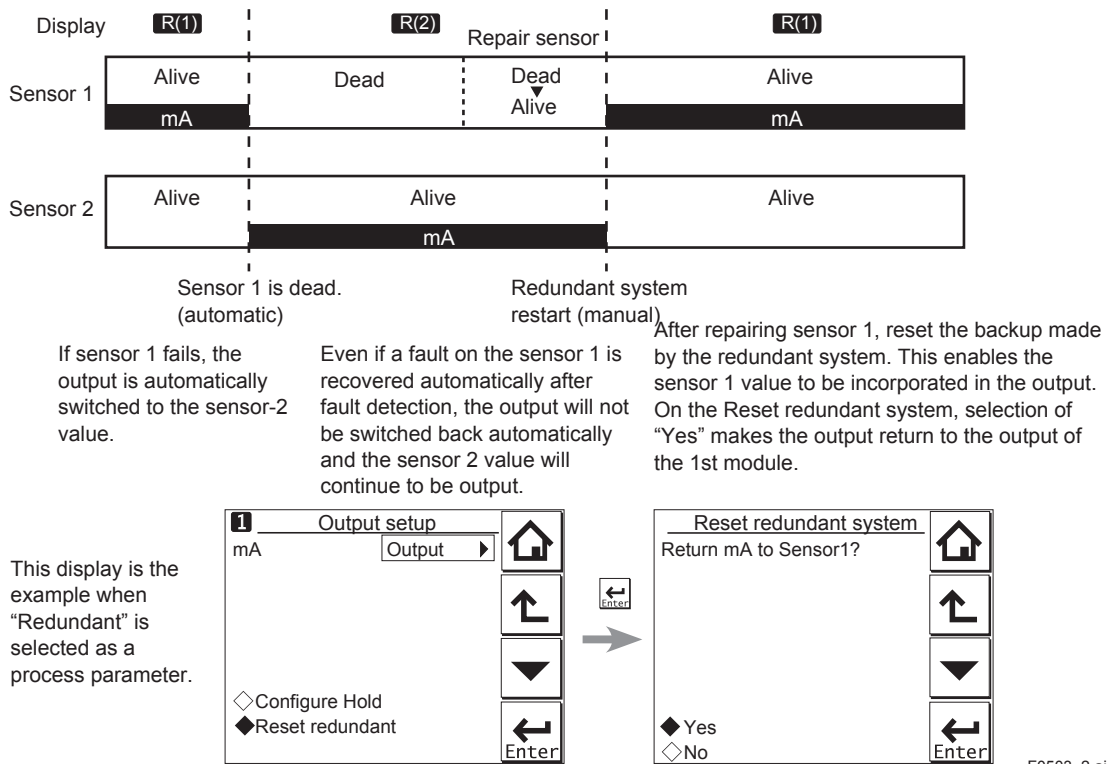

F0503\_2.ai

Figure 13.2 Redundant system

**Setup**

Select one of the output methods: Linear and Table.

Linear: Set the 0% and 100% values.

Table: This allows the configuration of an output curve by 21 points (5% intervals).  
(The 0% and 100% values must be entered. For the default values, see Table 13.3)

Table 13.3 Table of Default Values

%	0.000	5.000	10.00	15.00	20.00	25.00	30.00	35.00	40.00	45.00	50.00
Oxygen (mg/L)	0.00	1.00	2.00	3.00	4.00	5.00	6.00	7.00	8.00	9.00	10.00
Oxygen (ppm)	0.00	1.00	2.00	3.00	4.00	5.00	6.00	7.00	8.00	9.00	10.00
Oxygen (ppb)	0.0	5.0	10.0	15.0	20.0	25.0	30.0	35.0	40.0	45.0	50.0
Oxygen (%sat)	0.0	5.0	10.0	15.0	20.0	25.0	30.0	35.0	40.0	45.0	50.0
Temperature (°C)	0.0	2.5	5.0	7.5	10.0	12.5	15.0	17.5	20.0	25.5	25.0

%	55.00	60.00	65.00	70.00	75.00	80.00	85.00	90.00	95.00	100.0
Oxygen (mg/L)	11.00	12.00	13.00	14.00	15.00	16.00	17.00	18.00	19.00	20.00
Oxygen (ppm)	11.00	12.00	13.00	14.00	15.00	16.00	17.00	18.00	19.00	20.00
Oxygen (ppb)	55.0	60.0	65.0	70.0	75.0	80.0	85.0	90.0	95.0	100.0
Oxygen (%sat)	55.0	60.0	65.0	70.0	75.0	80.0	85.0	90.0	95.0	100.0
Temperature (°C)	27.5	30.0	32.5	35.0	37.5	40.0	42.5	45.0	47.5	50.0

**Burn**

Select the designated output in case of a fault from among Off, Low, and High. See "13.4 Error configuration" to set the output.

Off: Output depends on the measured value. (No fixed output is produced.)

Low: Output is fixed to 3.6 mA

High: Output is fixed to 22.0 mA.

**Damping time**

This is the time taken for a response to a step input change to reach 90% of the final value (attenuation time). Set this time in sec.

- **Simulate**

When this function is selected, an output of the instrument will be a fixed current value set in % of the output span. The output span range is -2.5% to 112.5% (3.6 mA to 22.0 mA).

When "Simulate" is selected, regardless of hold setting, the output is always simulated value.

- **Configure Hold**

On the Configure Hold, settings are performed to hold of the mA output at a preset value. (Refer to the section 14.5.) This is enabled only if "mA" is "Output."

During the Commissioning or the Quick Setup, the mA output is automatically held. The preset value depends on a setting on the "Last or fixed".

"Last": The preset value is a value measured just before hold condition.

"Fixed": The preset value is a value set in the "Fixed value mA".

When the "Fixed" is selected, set a mA value in the "Fixed value mA".

Selection on the "Hold during Calibration/Wash" decides to activate or deactivate the hold function automatically during calibration or wash.

"Enabled": Activation of the automatic hold function

"Disabled": No automatic hold function

Only when the "PH201G" is selected on the Communication, the message of "Hold during Calibration/Wash" is displayed. On other selections, the message of "Hold during Calibration" is displayed.

## 13.4 Error configuration

In Error configuration, configure the statuses of various error causes.

This allows the system to notify the user of the occurrence of an error according to the status categories in the Error configuration.

Select a status category from among Off, Warn. (Warning), and Fault.

"Fault" automatically performs burn-out. When Burn has been set to Off (13.3 Output setup), only the error message is displayed.

"Warn." displays an error message.

When selecting PH201G in the communication setting, make sure that the "Fail contact" setting is appropriate.

The settable causes of errors are determined based on the settings of the Sensor setup and Measurement setup, and a status category is set to the causes displayed in the Errors 1/2 and 2/2 screens.



**Table 13.4** Error configuration

Display item	Description	Default
DO too high	Input is over 50 $\mu\text{A}$ (galvanic) or 1200 nA (polarographic).	Warn.
DO too low	Input is below $-0.05 \mu\text{A}$ (galvanic) or $-1.2 \text{ nA}$ (polarographic).	Warn.
Temperature too high	Measured process temperature is higher than the maximum limit.	Warn.
Temperature too low	Measured process temperature is lower than the minimum limit.	Warn.
Sensor membrane	Sensor membrane is damaged.	Off
Calib. time exceeded	Calibration time exceeds the calibration interval (see Section 13.2.6).	Off

**CAUTION**

If canceling an error configuration could be risky, do not cancel it as a dangerous situation may result.

## 13.5 Logbook configuration

In “Logbook configuration,” the user configures information to be saved to a logbook or initializes the logbooks.

Logbooks are used to keep an electronic record of events such as error messages, calibrations, and programmed data changes. By referring to this log, users can, for instance, easily determine maintenance or replacement schedules.

In “Logbook configuration,” the user can select “Off,” “1-1,” or “1-2” for each item of interest to be logged. (For sensor 2, select “Off,” “2-1,” or “2-2.”) This can be done for items displayed on the Settings logbook 1/3 to 3/3 screens. Assigning 1-1 or 1-2 to each item allows information to be organized and logged in a logbook.

**NOTE**

Some events such as power-on are saved into the logbook “1-1” or “2-1”. This logbook may be full earlier. It is recommended that important information be saved into the logbook “1-2” or “2-2”.

For “Erase logbook”, a specified logbook “1-1” or “1-2” can be erased individually.

When the “Warn if logbook full” is set to “Yes”, a warning is given when the logbook come to near full (maximum 13 pages).

**NOTE**

When the logbook gets full, the oldest information is erased automatically.

## 13.6 Advanced setup

Advanced setup is used to set functions relating to matters other than measurements such as the selection of settings, tag setting, password setting for protecting calibration and commissioning operations, date setting, and communication setting.

(“Factory setup” is for service engineers only; there is no item to be set by the user.)

### 13.6.1 Settings

In “Settings,” select an item to be set as the default value from among “No action,” “Load factory settings,” “Save user settings,” and “Load user settings.”

When the default values are loaded, the instrument will be restarted. (In the case of “Save user settings,” it will not be restarted.)

The following parameters are not included in the defaults:

- Tag
- The contents of all logbooks

#### NOTE



When the “Save user setting” is only selected, save of the user-set parameters will start at once.

To avoid wrong selection, operation in this Settings must be done by , not by touching the menu message.

If you select “Load factory settings,” the instrument will be set to the default settings at factory shipment.

When this item is selected, a screen prompting whether to restart is displayed. If this is no problem, press “Yes.” Then the “Loading ...” message appears and blinks and loading is started. When the factory settings have been loaded, the instrument will be restarted.

When “Save user settings” is selected, the current settings can be saved as the defaults. When this item is selected, the user settings will start to be saved immediately. After saving the

parameters, press  or  to change the display because this save doesn't have restart function.

If “Load user settings” is selected, the settings saved as user settings can be set as the defaults.

When this item is selected, a screen prompting whether to restart is displayed. If this is no problem, press “Yes.” Then the “Loading ...” message appears and blinks and loading is started. When the user settings have been loaded, the instrument will be restarted.

### 13.6.2 Tag

A tag provides a symbolic reference to an instrument and is generally defined to be unique throughout the control system at one plant site. A tag can contain up to 12 alphanumeric characters. The default value is DO or FLXA21-DO. When two sensor modules are installed, each module can have their own tag numbers.

The tag is displayed at the top of the main and home displays.

### 13.6.3 Passwords

Calibration and commissioning operations can be separately protected by each password. To protect execute operations, enter a password in Execute's input field. To protect commissioning operations, enter a password in Commissioning's input field. By default, both input fields are empty. When a password input field is empty, operation is not password-protected. A password can contain up to 8 characters.

When you set a password, always take a note of it.

When a password is set, input of the password is necessary to enter the password-protected operation. After inputting the password, the display will change to an operator ID input display. When an operator ID is input, its operation is recorded into a logbook. The input of an operator ID is not necessary to enter the operation. An operator ID can contain up to 4 characters.

### 13.6.4 Date/Time

The Logbooks and trend graphs use the clock/calendar as a reference. The current date and time is set here. The time display format can be selected from among three types.

### 13.6.5 Communication

In "Communication," select the communication setting from among None, HART, and PH201G. The burn down current value is 3.6 mA.

#### NOTE

To make the change of "Communication" valid, turn off the power supply once, and reboot.

In the case of "None," there is not the problem even if you do not change it as "HART" of default value.

#### ■ HART

Select this menu when HART communication (HART 5) is made.

In the HART setup screen, specify the network address and set up parameters for SV, TV, and FV.

(PV is linked with the "process parameter" setting in "Output settings" and cannot be changed here.)

##### ● Network address

For 1-to-1 communication, leave the default value [0] unchanged. For multi-drop where multiple HART devices are connected on a bus, set addresses in 1 to 15. In this case, the mA output will be fixed to 4 mA.

##### ● PV

PV is a parameter selected for analog output; it cannot be changed here.

##### ● SV, TV, FV

The SV, TV, and FV parameters are items that the user must set up. Selectable items differ depending on the sensor type in "Sensor setup" and settings in "Measurement setup."

If blank is selected for a parameter, items below that parameter must all be set to blank. If an item is blank, those below it cannot be set to a status other than blank.

For more information on HART communication, see the Technical Information (TI 12A01A02-60E) in the attached CD-ROM.

## ■ PH201G

Select this menu if the PH201G distributor is connected to the instrument.  
In the PH201G setup screen, make settings for “Hold contact,” “Fail contact,” and “Wash contact.”

### ● Hold contact

Select Disabled or Enabled.

When this item is enabled, the output will be held according to the setting of “Hold type” on the Hold setup screen.

### ● Fail contact

Select a status from among “Fail + Warn,” “Fail only,” and “Disabled.”

This setting depends on the error configuration. See “13.4 Error configuration.”

“Fail” corresponds to “Fault.”

### ● Wash contact

Select Disabled or Enabled.

When this item is enabled, items for a wash can be set on the Wash settings screen.

In the Wash settings screen, set the interval time, wash time, and recovery time and setup of various washes.

Interval time: Set the wash interval in hours.

Wash time/measure time: Set the wash time in minutes. In a continuous wash, wash time is replaced by measure time.

Recovery time: Set the recovery time in minutes.

Manual wash: Select “Disabled” or “Enabled.”

When this item is enabled, a wash cycle can be activated manually. On the Calibration/Wash screen, press the “Start manual wash cycle” to perform a manual wash.

Imp2 wash: Select “Disabled” or “Enabled.”

When this item is enabled, a wash cycle can be started if the “Impedance 2 too high” error occurs with respect to the reference electrode.

Continuous wash: Select “Disabled” or “Enabled.”

A continuous wash cycle is started at the instant when this item is enabled.

In a continuous wash, the “Measure time” and “Interval time” are reversed (see Figure 13.3).

When a continuous wash is disabled

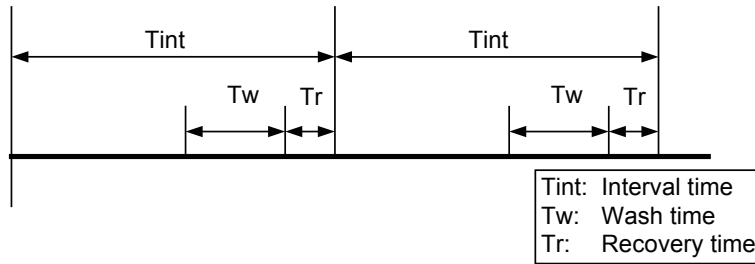

When a continuous wash is enabled

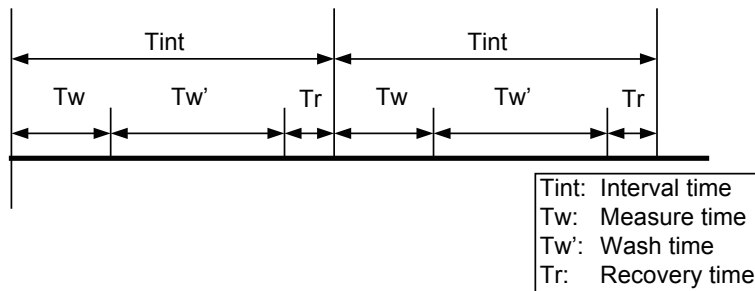

F050605\_2.ai

Figure 13.3

### 13.6.6 Factory setup

For “Factory setup,” there is no item to be set by the user.

#### NOTE

This menu is for service engineers only. This section is protected by a password. Attempting to change data in the factory adjustment menu without the proper instructions and equipment could result in corruption of the instrument setup and damage the performance of the unit.

## 13.7 Display setup

This screen is used to make various settings relating to screen display.

### 13.7.1 Main display (Dual display, Individual display)

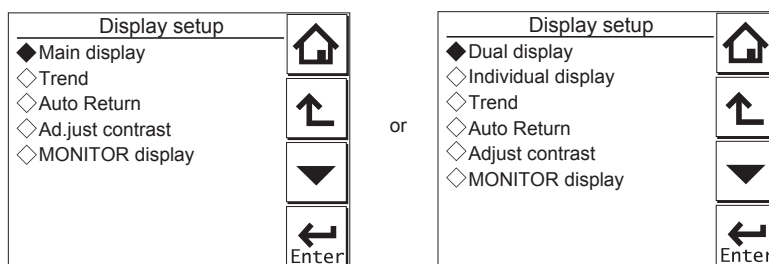

Figure 13.4 Display setup screens for a single module (left) and two modules (right)

- **Main display**

When one module is installed on the instrument, only the Main display is available.

Three measurement values can be set to display on the Main display as a primary value (1st line), a second value (2nd line) and a third value (3rd line) respectively.

On the “Additional text”, a text of up to 12 alphanumeric characters can be assigned to each measurement value.

Additional texts are displayed on the Main display, and are useful for identifying measurements. In some cases, not all 12 characters can be displayed due to the letters; check the texts displayed on the Main display after setting. If a part of the text is missing, adjust the number of characters.

- **Dual display**

This screen is used to set items to be displayed in the top part (1st row) and bottom part (2nd row) of the Home display. These settings are available when two sensors are installed in the instrument.

When the “Empty” is selected for the 2nd row, the Home display can not be displayed.

- **Individual display**

When two modules are installed on the instrument, display items on the Main display for each module can be set on these settings.

On the “DO1 display” or “DO2 display” screen, three measurement values can be set to display on each Main display as a primary value (1st line), a second value (2nd line) and a third value (3rd line) respectively.

On the “Additional text”, a text of up to 12 alphanumeric characters can be assigned to each measurement value.

Additional texts are displayed on the Main display, and are useful for identifying measurements. In some cases, not all 12 characters can be displayed due to the letters; check the texts displayed on the Main display after setting. If a part of the text is missing, adjust the number of characters.

## 13.7.2 Trend

This screen is used to make settings for the Trend Graph Screen.

Set the process parameters to be displayed for each trend. They can be set for the 1st to 3rd trends. When all three process parameters are set “Empty”, there is no trend display (no trend button).

- **X-axis: Timing**

Select the X-axis timing’s time span on the trend graph display from a list.

- **Y-axis: Limits**

Set the Y-axis high and low limits on the trend graph display on a Trend screen basis.

### **NOTE**

Updating the trend display setup resets the current trend graph and starts a new one.

### 13.7.3 Auto Return

When no operation is performed for the time set in “Auto Return”, the display returns to the Monitor display (or to the Main display when the MONITOR display is disabled) and the analyzer returns to a normal measuring mode. (When the Trend display is selected, the Auto Return doesn't work.)

Select the time from among Disable, 10 min, and 60 min. When the Auto Return function is not used, select “Disable.”

#### NOTE

A default is “10 min”. When maintenance like a calibration that may take much time is performed, “60 min” or “Disable” is recommended to be selected.

### 13.7.4 Adjust contrast

The LCD screen contrast can be adjusted.

Pressing the ▲ ▼ keys adjusts the contrast in 11 levels from +5 to –5 (including the default value of “0”).

### 13.7.5 MONITOR display

Select “Enable” so that the Monitor display becomes available. A default is “Enable”.

During Hold/Wash condition and a warning/fault condition, the Main display or the Home display is displayed to indicate the condition.

## 13.8 Calculated data setup

On this setup, parameters can be set for calculated data.

When two modules are installed on the instrument, the calculated data can be set for values measured by two sensors.

Select “Differential” or “Average” on the Calculated data setup screen.

**Differential:** A difference between measurement values measured by a sensor 1 and sensor 2 is an output as a calculated result.

(Diff)  $(\text{value of the sensor 1}) - (\text{value of the sensor 2})$

**Average:** The average of measurement values measured by a sensor 1 and sensor 2 is an output as a calculated result.

(Ave)  $(\text{value of the sensor 1} + \text{value of the sensor 2}) / 2$

To display the calculated result, select “Calculated” on the Dual display screen. (Section 13.7.1.) (The setting on the “Individual display” has no effect.)

While displaying a calculated data, measurement value of the sensor 1 or sensor 2 can be

checked on the each sensor's display with pressing  or  at the lower right on the Main display.

Pressing  returns the display to the original calculated data display.

A calculated data can be set as a process parameter on the “mA (Output)” setup screen. (Section 13.3.)

# 14. CALIBRATION OF DO (Dissolved Oxygen)

Calibrate dissolved oxygen sensors after installing or replacing them, cleaning the membrane, or replacing the electrolyte solution.

Air, water, and manual calibrations are available.

Air calibration is the most common and easiest method. Water calibration is more accurate.

Manual calibration uses manually analyzed sample water and adjusts the sensor to the value.

## NOTE

A default is “10 min” for “Auto Return”. When maintenance like a calibration that may take much time is performed, “60 min” or “Disable” is recommended to be selected. (Refer to the section 13.7.3.)

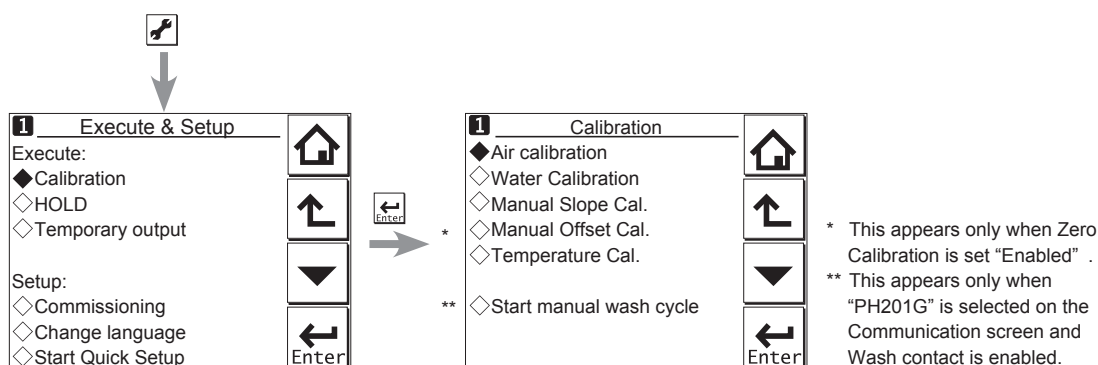

Figure 14.1 Calibration

The calibration items include “Air calibration,” “Water Calibration,” “Manual Slope Cal.,” and “Temperature Cal.”

When Zero Calibration is set “Enabled” (see section 13.2.6), “Manual Offset Cal.” is available.

Press to select “Execute: Calibration,” choose the calibration object, and configure the calibration to perform it. Calibration is made stepwise; follow the prompts displayed on the screen to carry it out.

A stability check is conducted at each measurement point. Proceed to the next step only after the reading has stabilized.

## NOTE

While “CHECKING STABILITY...” is indicated, the instrument automatically checks the stability of the measurement (input value). If the stability is not confirmed within 60 min, an error is issued and the procedure is aborted. Change the parameters in the stabilization time and step range as necessary (see Section 13.2.6), and then recalibrate the sensor.

## NOTE

When a sensor or a membrane is exchanged or replaced, sensor wellness data should be reset. When a sensor is replaced, the replacement can be recorded manually into a logbook. (Refer to the figure 12.9.)



## 14.1 Air calibration

Span calibration in the ambient atmosphere is the most common and easiest method.

Although setting the Zero Calibration to “Enabled” allows 2-point calibration of Zero (0%) and Span (100%), only span calibration is generally performed. For zero calibration, see the next section.

Set the sensor in the maintenance mode. Wash off any stain on the membrane and use a soft tissue to wipe off any remaining water from the membrane.

Leave the sensor in an environment without temperature fluctuation or air flow for about 10 minutes, such as in an empty container. After confirming that the reading is stable, calibrate the sensor.

## 14.2 Water calibration

Water calibration is a method of calibrating dissolved oxygen analyzers in a laboratory. Accurate results can be obtained if the span calibration is performed carefully in air-saturated water.

Although setting the Zero Calibration to “Enabled” allows 2-point calibration of Zero (0%) and Span (100%), the reading must have been stable before performing zero calibration. Therefore, zero calibration takes a relatively long time.

Conduct water calibration in fresh water. For zero calibration in salt water, perform it by manual calibration.

Set the sensor in the maintenance mode. Wash off any stain on the membrane and use a soft tissue to wipe off any remaining water from the membrane.

- **Air-saturated water**

Pour water (without salt content) into a beaker or other container, and place it on a magnetic stirrer or other agitator. Put a stirring bar in it and agitate the water, and send air from a pump (bubbling). It takes 15 to 30 minutes until the water is fully saturated. Then put the sensor in this water which is still agitated and bubbling, and calibrate it. Keep the sensor at least 3 cm above the bottom of the beaker to prevent the membrane from directly contacting the air bubbles.

- **Water for zero calibration**

Zero calibration takes a long time and normally there is no need to perform it. A clean sensor does not have a zero current and thus does not require zero calibration.

For the zero calibration water, dissolve 20 to 30 grams of sodium sulfite in 1 liter of desalinated water.

### **NOTE**

Dissolve sodium sulfite in the water and wait until the reading becomes stable before calibrating the sensor. Even a healthy sensor needs 40 to 50 minutes. Leave the sensor in the solution.

## 14.3 Manual slope calibration

Calibrate the sensitivity of the sensor with a solution of known oxygen concentration.

First, analyze the oxygen concentration of a sample solution and then calibrate the sensor sensitivity to adjust to this value. From the actual measurement of salinity and temperature, obtain the dissolved oxygen concentration by referring to Table 1 in Appendix 4 and enter it.

When salinity must be considered, perform the calibration manually.

Note the following:

- Quickly analyze the sample water to prevent the dissolved oxygen concentration or temperature from changing.
- Before analyzing the sample water, analyze the reference with a calibrated laboratory instrument.
- To eliminate any discrepancies, the laboratory instrument must have been calibrated with the same calibration data as specified in ISO 5814.

Confirm that the reading of the instrument is stable and the sensor is clean. If the reading remains unstable, set the sensor in the maintenance mode and wash off any stain on the sensor membrane. Return the sensor to the sample water and leave it until the reading becomes stable.

### ● Salinity compensation

To compensate salinity, select “Enabled” in “Measurement setup” – “Salinity compensation” – “Compensation” (see Section 13.2.4).

Perform calibration by referring to Table 1 in Appendix 4.

#### Example:

When the atmospheric pressure is 101.325 kPa, the solution temperature is 22.5°C, and the salinity is 30 g/kg (3 wt% seawater equivalent):

- (1) Calculate the saturated concentration of desalinated water.

According to Table 1 in Appendix 4, the saturated concentration is 8.74 mg/l at 22°C and 8.58 mg/l at 23°C.

The value at 22.5°C is calculated as follows:

$$8.74 + (8.58 - 8.74) \times (22.5 - 22) = 8.66 \text{ mg/l}$$

- (2) Compensate the value for salinity.

The compensation value for 30 g/kg salinity at 22.5°C is calculated as follows:

$$0.0453 + (0.0443 - 0.0453) \times (22.5 - 22) = 0.0448 \text{ mg/l}$$

$$0.0448 \times 30 = 1.34 \text{ mg/l}$$

- (3) Calculate the saturated concentration of the solution (for calibration).

The saturated concentration for 30 g/kg salinity at 22.5°C is calculated as follows:

$$8.66 - 1.34 = 7.32 \text{ mg/l}$$

## 14.4 Temperature calibration

For the most accurate measurements, it is important to have a precise temperature measurement. Measure the temperature with a high-precision thermometer and adjust the sensor reading accordingly. For best accuracy, this should be done as near to the normal operating temperature as possible.

## 14.5 HOLD

The FLXA202/FLXA21 has a function to hold the mA output at a preset value (default: "Last"). Use this menu to hold the output.

For the settings, see "■ Configure Hold" on page 13-7.

During commissioning or quick setup, the output is automatically held.

Setting "Hold during Calibration/Wash" to "Disabled" deactivates the hold function during calibration or washing.

Press  to select Execute: HOLD and then choose Manual Hold ON or Manual Hold OFF. This allows you to set up manual hold.

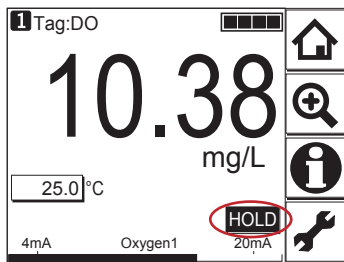





Figure 14.2 Example of the display with the manual hold enabled

To cancel manual hold, press the lit  section on the Main display.

## 14.6 Temporary output

If measurement cannot be made due to replacement of one of the sensors, assignment of mA output can be temporarily changed from the currently setup sensor to the other sensor. This feature is enabled only when two sensors are connected.

Press  to select Execute: Temporary output and then choose the process parameter to be assigned on the Temporary output screen.

When process parameter assignment has been modified, the  indication at the upper left of the screen changes to .

The feature is disabled the moment the screen returns to the Main display, and the setting (process parameter in mA output setting) returns to the original condition.

# 15. OPERATION OF SENCOM pH/ORP

This chapter describes the screen operations of SENCOM pH/ORP, the object to be measured. Further details of screen operations can also be found in section 1.2.

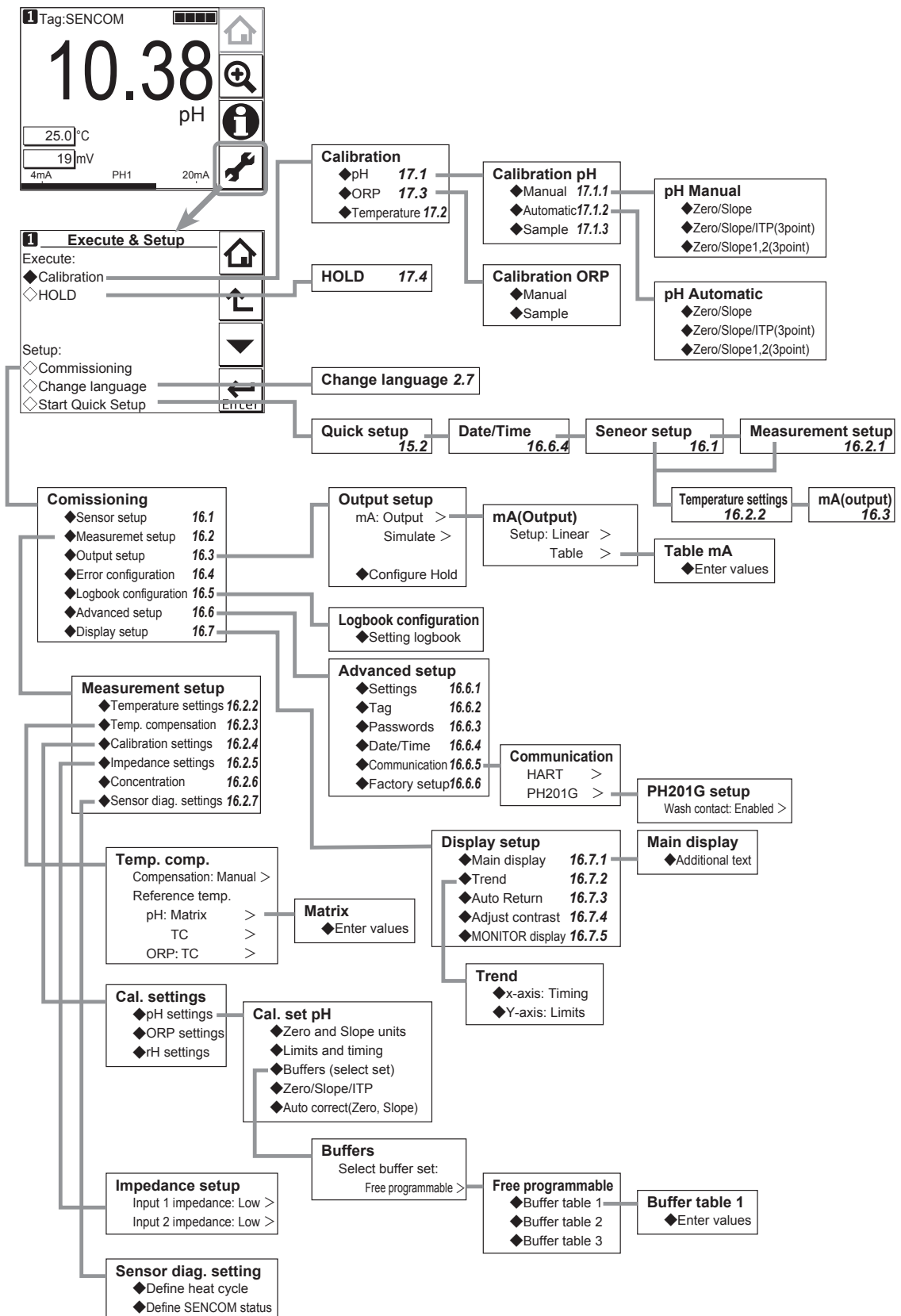

Figure 15.1 Menu structure of SENCOM pH/ORP (the number after the item refers to the relevant section)

---

## 15.1 Change language

The screen is set to display English at factory shipment; if you wish to use the FLXA202/FLXA21 in another language, first select a language as described in section 2.7.

## 15.2 Quick setup

The Quick setup screen is used to set up the basic items you want to set up first, such as the date/time and sensor settings. The detailed settings are described in chapter 16, Commissioning.

You may leave the Quick setup now and return to it later; however, it is recommended to perform the quick setup first.

Each time the FLXA202/FLXA21 is started up, this screen is displayed. If it is not necessary to

change the setup, press No or .

---

### NOTE

When no operation is performed for 10 minutes or 60 minutes (depending on the setting of "Auto Return"), the display except Trend display automatically changes to the Monitor display (or to the Main display when the MONITOR display is disabled).

---

---

### NOTE

The display may show "---- (bar)" when starting measurement, which means the sensor is not ready to measure. But the temperature is displayed normally. Wait until measurement values are displayed.

---

While a bar (----) is displayed, as for the mA output, in the case of "Off" or "Low," [Burn] of the Output setup (see section 16.3) is fixed 3.6mA, and, in the case of "High," 22.0mA becomes fixed.

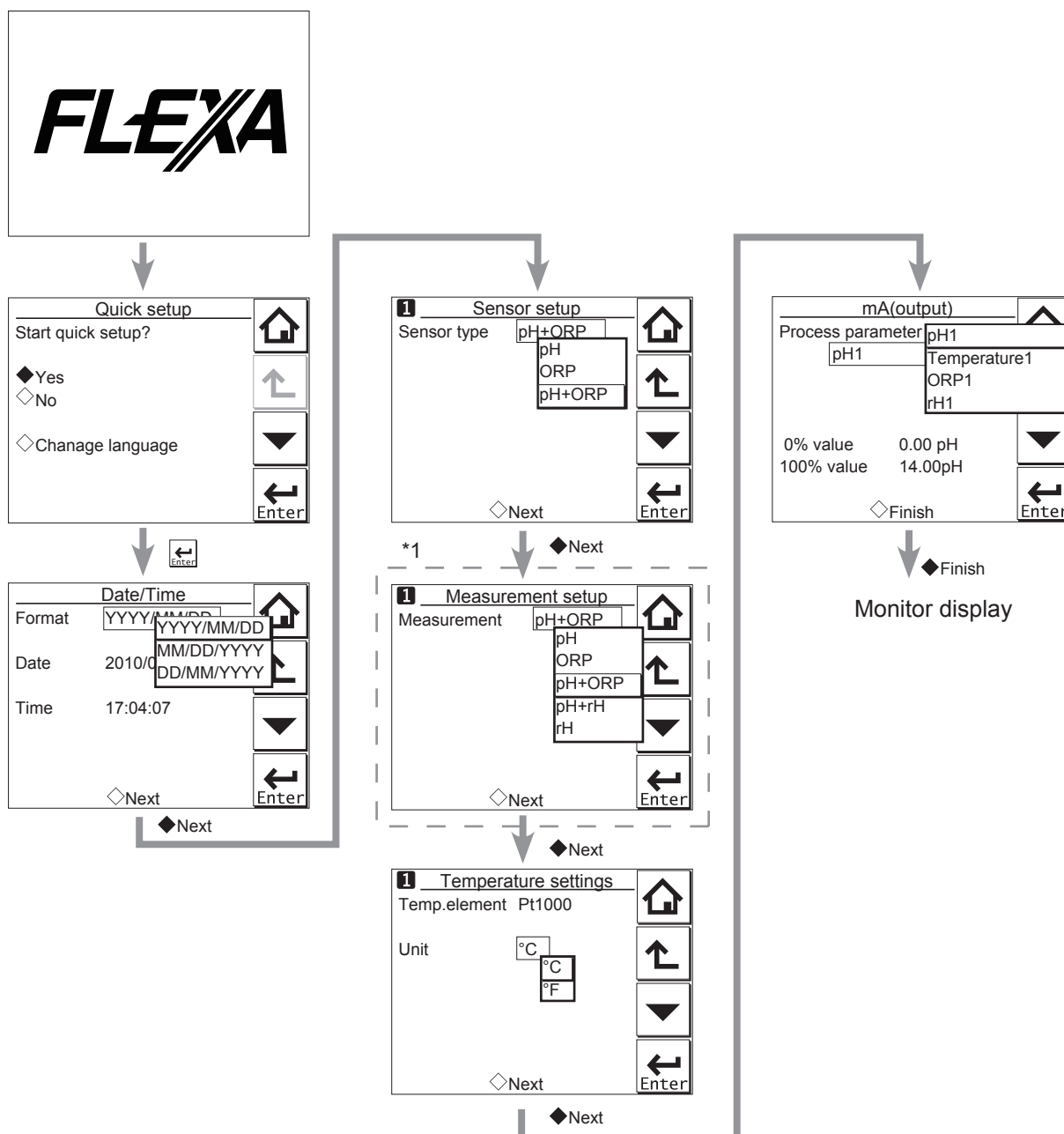

\*1: The Measurement setup screen appears only when "pH + ORP" is selected on the Sensor setup screen.

**Figure 15.2 Quick setup**

**Date/Time**

The date display format can be selected from among the three types.

Enter the date or time of day by using the numerical keys.

For details, see section 16.6.4.

**Sensor setup**

Select a suitable electrode from among the displayed electrode types and set it up.

For details, see section 16.1.

## ■ Measurement setup

Select a suitable measurement parameter from among those displayed and set it up.

Measurement parameter setup can be made only when “pH + ORP” is selected on the Sensor setup screen.

For details, see section 16.2.1.

## ■ Temperature settings

In the case of temperature sensors, the temperature parameter is automatically set when connection is made.

Celsius (°C) or Fahrenheit (°F) temperature scale can be selected.

For details, see section 16.2.2.

## ■ mA (output)

Select a suitable process parameter from among those displayed and set it up.

For example, the mA output of pH has been set to 0 – 14 pH at factory shipment. If the resolution needs to be improved, set a suitable value for the process.

For details, see section 16.3.

## 15.3 Main display and Monitor display

Pressing  changes the screen to the Main display shown in Figure 15.3.

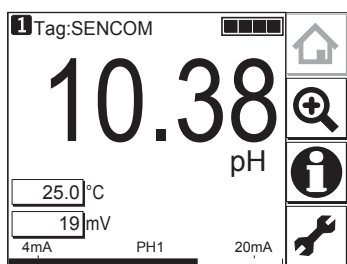

**Figure 15.3** Example of main display

On the Main display, pressing  of the 2nd or 3rd display item causes the 1st display item to be replaced by the selected item.

### NOTE

Measured values to be displayed in the 1st to 3rd display items depend on the user definition (see section 16.7.1). For example, on the default condition of pH measurement, the 1st display item is pH, the 2nd display item is temperature, and the 3rd display item is empty.

When the MONITOR display is enabled (see section 16.7.5), pressing the 1st display item on the home display or the main display changes the display to the Monitor display with the enlarged font of the measured value.

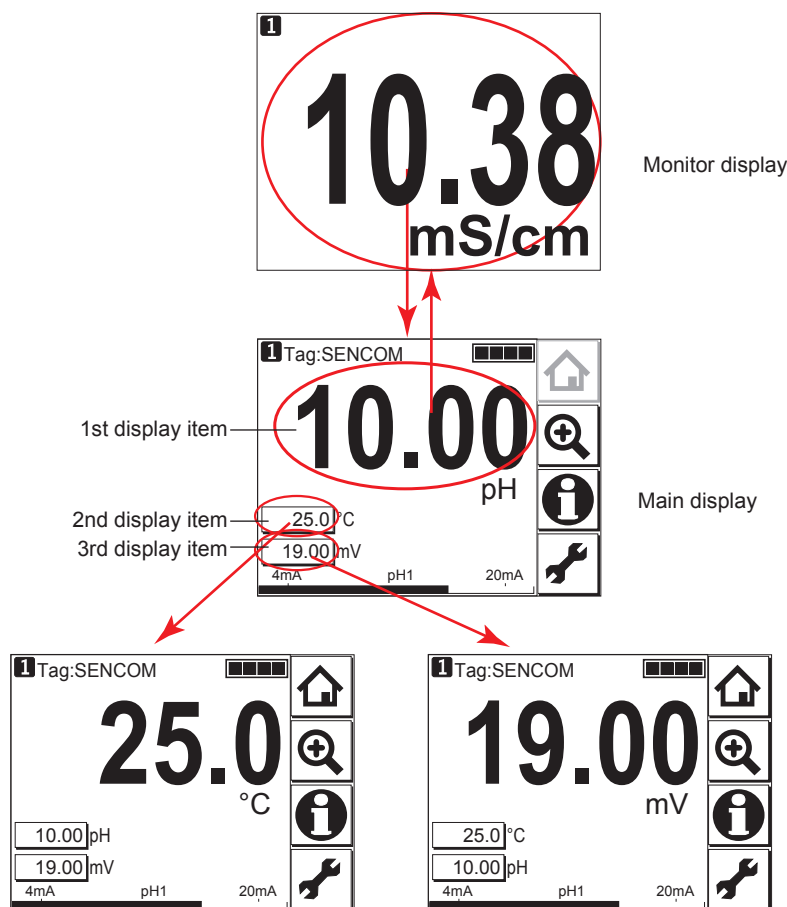



Figure 15.4 Change display

## 15.4 Zooming in on details

Pressing  on the Main display allows you to check detailed instrument information (instrument information such as setup, sensor diagnosis, calibration, and module productions number) through a transition of screens as shown in Figure 15.5.

In case of trouble, when you contact your nearest Yokogawa service center, please inform us of the module and FLXA202/FLXA21 software revision displayed on the Detail screen and other display information as well as the module productions number indicated on the nameplate attached to the instrument.



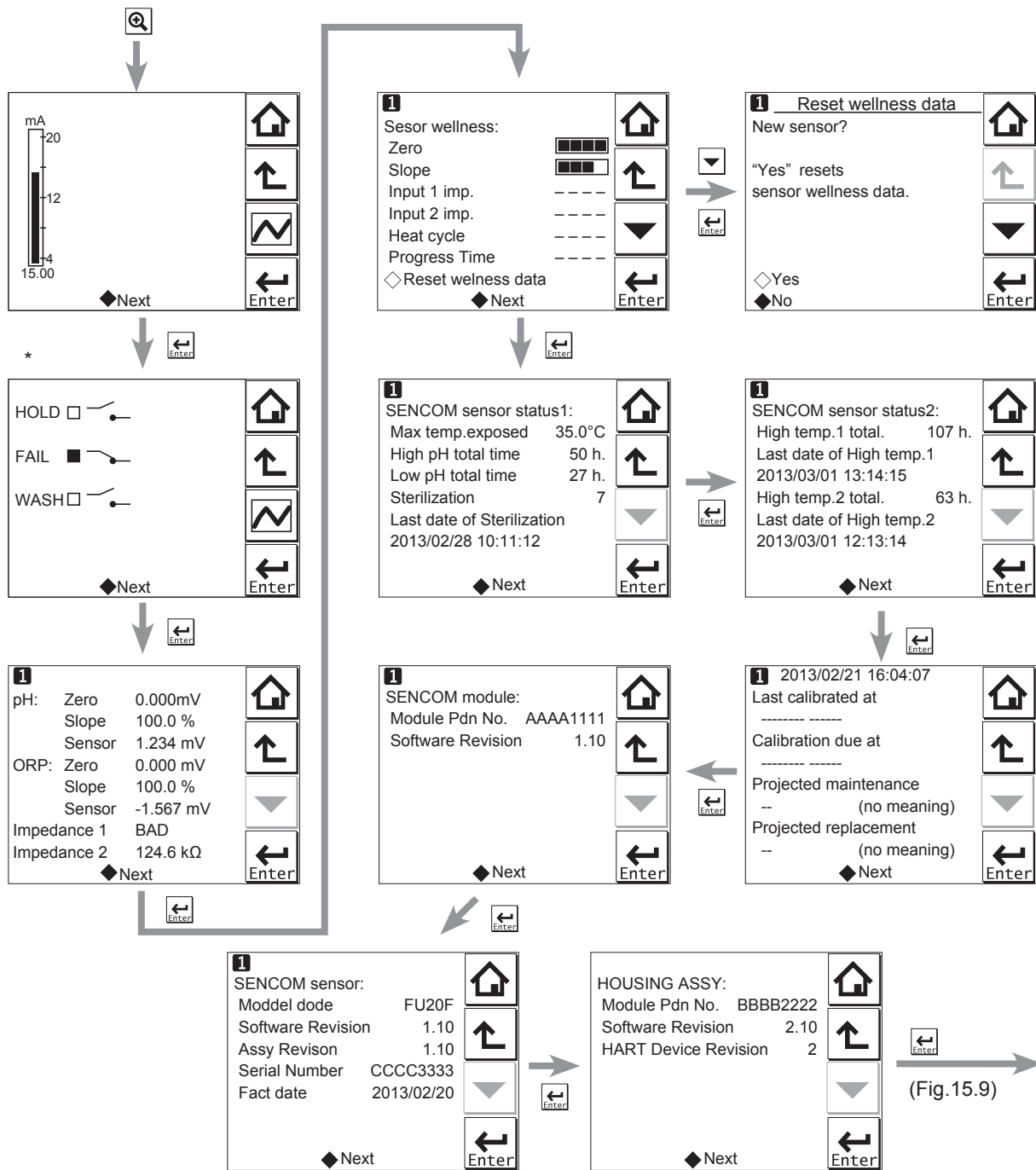

\*: This screen is displayed only if the PH201G distributor is used and "PH201G" is selected in communication setup.

Figure 15.5 Detail display

### ■ Current output mA

= current output in mA. The range and function of this mA output can be set in Commissioning → Output setup → mA.

For details, see section 16.3.

### ■ Contact status

This screen is displayed only if the PH201G distributor is used and "PH201G" is selected in communication setup.

## ■ PH (ORP)'s zero, slope, and sensor, and Impedance

### ● Zero

= calibrated sensor offset in mV. Theoretically, the sensor reads 0 mV in a buffer solution of pH 7. The ZERO value indicates the condition of the sensor. The trend of ZERO drift of the sensor is used to predict the lifetime of the sensor.

ZERO can also be displayed in pH units and then it represents the pH value where the sensor output is 0 mV at 25°C. Setting can be made in Commissioning → Measurement setup → Calibration settings → Zero and Slope units.

Setting of the zero value can be made in Commissioning → Measurement setup → Calibration settings → Zero/Slope/ITP. For details, see section 16.2.4.

### ● Slope

= calibrated efficiency of the sensor unit as a percentage of the theoretical slope of the sensor unit. The theoretical slope follows the NERNST equation and is 59.16 mV/pH (at 25°C). The SLOPE can be calibrated only after a two-point calibration in buffer solutions with a different pH value. A low slope indicates that the sensor is not clean or is faulty.

The SLOPE can also be displayed as a mV/pH value at 25°C if the user has defined this variable as mV/pH in Commissioning → Measurement setup → Calibration settings → Zero and Slope units.

Setting of the slope value can be made in Commissioning → Measurement setup → Calibration settings → Zero/Slope/ITP. For details, see section 16.2.4.

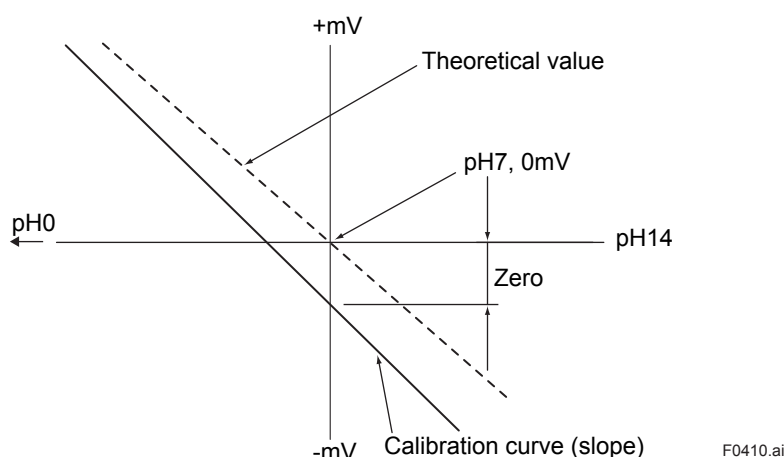

Figure 15.6 Zero/slope

### ● Sensor

Represents the electromotive force of the sensor.

### ● Impedance 1

For a PH sensor, “Impedance” shows electrical resistance of the glass membrane electrode. The FLXA202/FLXA21 checks the impedance to know damage of the electrode.

For an ORP sensor, “Impedance” shows electrical resistance of metal electrode.

The FLXA202/FLXA21 checks the impedance to know the surface condition of smudge and the snapping of sensor wires. In case of “Input Impedance setting” is “High” and the measured input-1 impedance value is higher than 100 kΩ, the display shows “MΩ RANGE”. The measured input-1 impedance value is lower than 100 kΩ, display shows “BAD”.

If both impedance measurements are disabled (Error setting: Off), the display shows “- - - (bar)”. If either impedance measurement 1 or 2 is enabled, the display shows both the impedance values.

## ● Impedance 2

Impedance shows the electrical resistance of the reference electrode liquid junction. The liquid junction forms the electrolytic contact between the reference electrode and the measuring electrode, so it must be kept clean and filled with conductive electrolyte. Otherwise the measurement will suffer from instability, drift and measuring errors. The electrical impedance is one of the most important.

In case of “Input Impedance setting” is “High” and the measured input-2 impedance value is higher than 100 k $\Omega$ , the display shows “M $\Omega$  RANGE”. The measured input-2 impedance value is lower than 100 k $\Omega$ , display shows “BAD”.

If both impedance measurements are disabled (Error setting: Off), the display shows “- - - (bar)”. If either impedance measurement 1 or 2 is enabled, the display shows both the impedance values.

## ■ Sensor wellness

At the Sensor wellness window, the soundness of a module is displayed. A larger number of ■ in each gauge indicates that the parameter concerned is sound. A gauge is indicated for only those parameters whose sensor wellness setting is “enabled,” while a bar (----) is displayed if the sensor wellness setting is “disabled.”

Sensor wellness setup can be made in Commissioning → Measurement setup → Sensor diag. settings. For details, see section 16.2.7.

The “Reset wellness data” button can reset wellness data.

When a sensor or electrode is exchanged or replaced, the warning “SENCOM changed” is displayed depending on the settings (see Section 16.4). Reset the wellness data of the sensor.

## NOTE

When a sensor is replaced, the replacement can be recorded manually into a logbook. (Refer to the figure 15.9.)

## ■ Last calibrated

= date on which the last sensor calibration was performed. The displayed value of the Zero is the result of this calibration. The displayed value of Slope was calibrated on this date only if the last calibration was a 2-point calibration.

## ■ Calibration due

= the date when the calibration must be done next according to the settings of the calibration interval. The calibration intervals are set in Commissioning → Measurement setup → Calibration settings → Limits and timing.

## ■ Projected maintenance

The projected maintenance function predicts the date when the sensor unit will need recalibrating for maintaining measurement accuracy. The function checks the input-2 impedance (reference impedance) every 24 hours.

The function predicts the date when the input-2 impedance will cross the upper or lower limits, and indicates the date and its status (the status is displayed in parentheses).

As shown in Figure 15.7, the date is predicted based on the intersection point of the upper or lower limits and the extrapolated line of the values obtained by the least squares method.

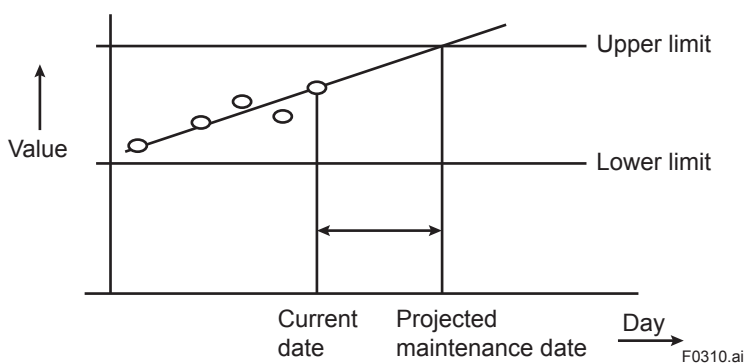

Figure 15.7

The status shows the certainty of the projected maintenance date in terms of the correlation coefficient R. Tables 15.1 and 15.2 show respective display patterns.

Table 15.1 Display pattern of the projected maintenance date

Projected date	--	0-1 month	1-3 months	3-6 months	6-12 months	Over 1 year
----------------	----	-----------	------------	------------	-------------	-------------

-- : cannot be predictable due to insufficient data

Table 15.2 Display pattern of the status

Status	(----)	(Poor)	(Reasonable)	(Excellent)
	( $R < 0.50$ )	( $0.50 \leq R < 0.70$ )	( $0.70 \leq R < 0.85$ )	( $0.85 \leq R < 1.00$ )

## ■ Projected replacement

The projected replacement function predicts the date when the sensor will need replacing for maintaining the measurement accuracy, based on the pH zero and pH slope on each calibration, and reference impedance (input-2 impedance) after each calibration. The projected replacement date is predicted based on these parameters stored upon calibration, and displayed the same as that of projected maintenance. For details, see the description about the projected maintenance. Since three parameters (pH zero, pH slope, and input-2 impedance after calibration) are used for this projection, the nearest coming day is selected as the projected replacement date from the extrapolated line of the values obtained by the least squares method.

## ■ SENCOM sensor status

The status of the SENCOM sensor is displayed.

### Max temp. exposed

Displays the maximum temperature, which is automatically updated every time a higher temperature is measured.

### High pH total time/Low pH total time

Displays the total time during which the pH value remains above the upper pH limit or below the lower pH limit.

Up to 10 years (87600 hours) can be counted, after which the time is no longer updated. For the setting of the parameters, see Section 16.2.7.

### Sterilization

Displays the number of times the temperature remains above the preset value for at least the prescribed time period (min.). For the setting of these parameters, see Section 16.2.7.

Figure 15.8 shows an example of sterilization.

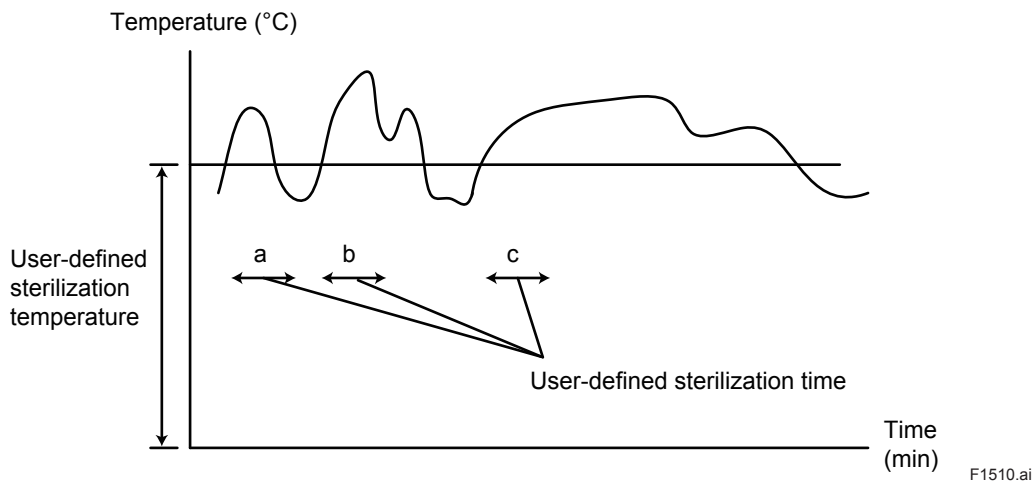

**Figure 15.8 Sterilization**

- a: This event is not counted because the duration does not reach the prescribed sterilization time.
- b: This event is counted because the duration exceeds the prescribed sterilization time.
- c: This event is counted because the duration exceeds the prescribed sterilization time. However long the event lasts, it is counted as one.

The date and time of the last count is displayed as the "last date of sterilization."

The number of counts is up to 9999. Even after that, the "last date of sterilization" is updated if the event meets the conditions.

#### **High temp. 1 total/ High temp. 2 total**

Displays the total time during which the temperature remains over the high temperature 1 or 2 (see Section 16.2.7).

The last date and time (the end of high-temperature condition) is displayed as the "last date."

Up to 10 years (87600 hours) can be counted. Even after that, the "last date" is updated if the event meets the conditions.

### ■ **SENCOM module**

This screen enables operators to check the module production number and software revision of the installed model.

### ■ **SENCOM sensor**

This screen enables operators to check the information of the connected sensor, including the model code, software revision, assembly revision, serial number, and manufacturing date.

### ■ **HOUSING ASSY**

With this screen, you can check the module productions number, software revision, and HART device revision of the housing assembly.

### ■ Read logbook

The FLXA202/FLXA21 has three types of logbook per sensor to store history information regarding the setting changes and calibration.

By selecting a desired logbook, you can retrieve and check the information. The Configure logbook screen is used to set whether to store history information of each event and which logbook to use for storage. The SENCOM logbook cannot be designated. For details, see Section 16.5.

The logbook automatically records events such as calibration and errors.

Fixed messages can be manually stored in logbook1-1 and logbook1-2.



To store these messages, press  and select one of three messages from the Item on the Memorandum screen. Its event date/time will be the time when a message is selected and entered.



When a password for Commissioning is set on the passwords' setup, pressing  requires entering the password. (Refer to the section 16.6.3.)

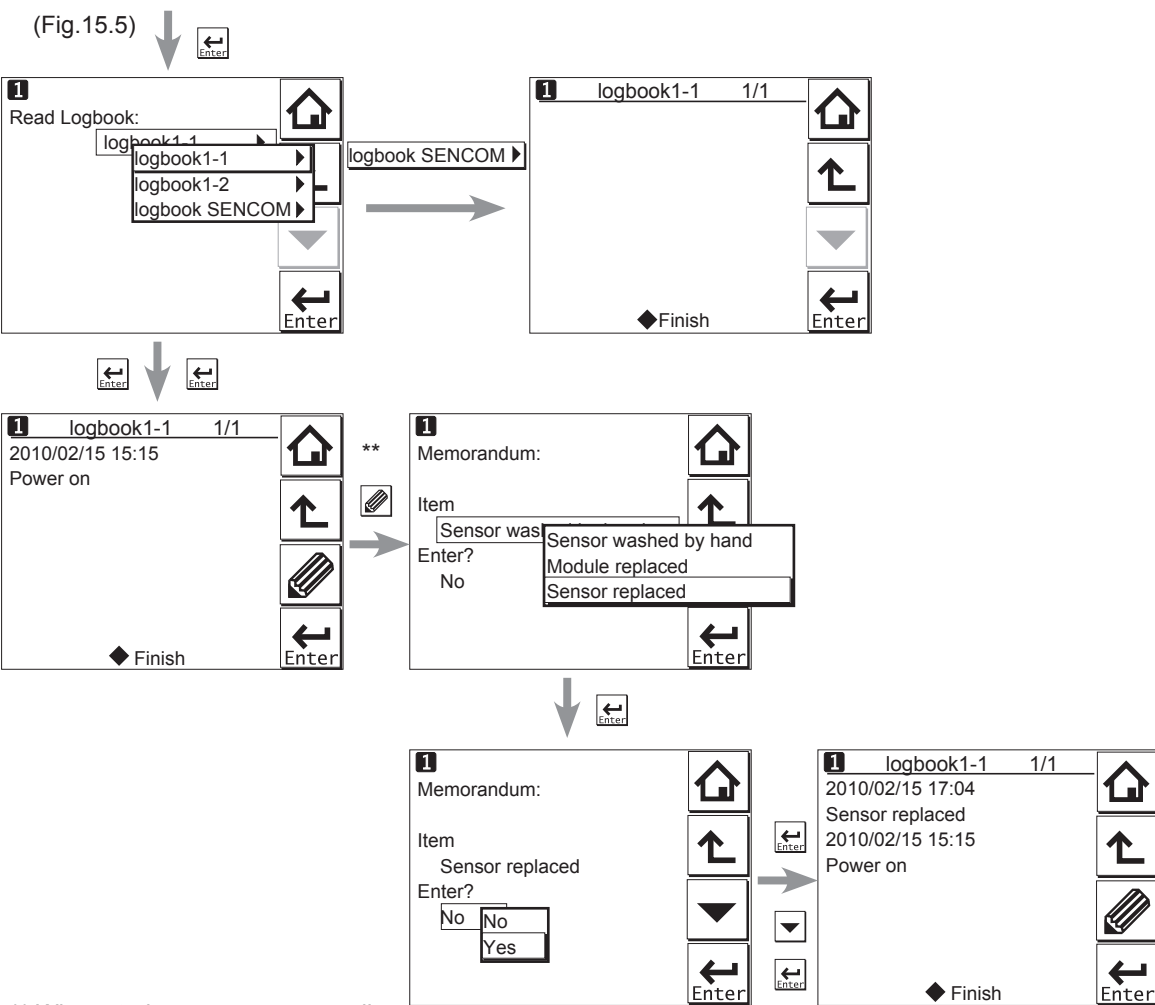

\*\* When storing message manually.

Figure 15.9 Detail display (continued)

## 15.5 Trend graphics



Pressing  on the Zoom display changes the display to a graphical mode in which the average measured value is shown on a time scale. The “Live” value is also digitally displayed in a text box. The time scale (X-axis) and the primary value scale (Y-axis) are set in the “DISPLAY SETUP” menu (Section 16.7.2).

The screen displays the trend of up to 41 averages of the measurement for each time interval. The FLXA202/FLXA21 samples the measurements every second. The trending graphic also shows the maximum and minimum measured values in that interval.

For example, if the time scale is set to 4 hours, then the trend is shown for 4 hours prior to the actual measurement. Each point on the trend line represents the average over  $4 \times 60 \times 60 / 41 = 351$  measurements (seconds).

### NOTE

Updating the trend screen setup resets the current trend graph and starts a new one.

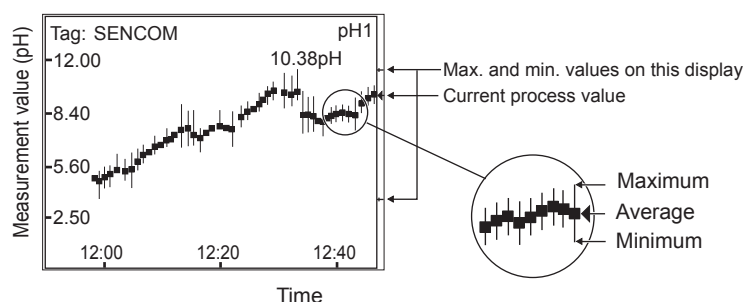

**Figure 15.10** Trend screen

The 1st display item data on the Main display is shown as a graph. Touching any point on the display changes the display to the 2nd display item data (and to the 3rd display item data if set) and then returns to the Main display.

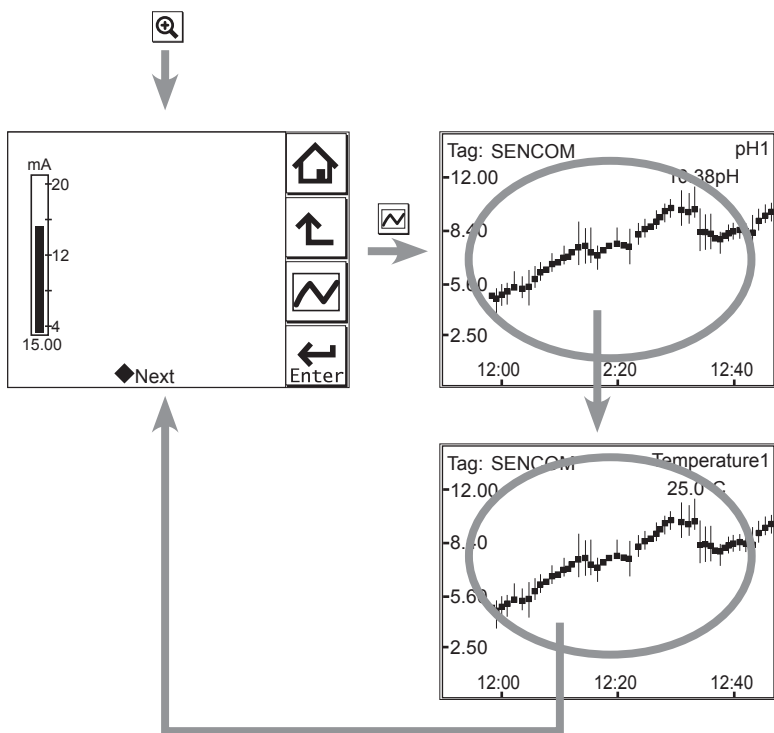

Figure 15.11 Trend graphics

## 15.6 Instrument status screen

In the  field of the Main display, the  (Warning) or  (Fault) sign appears according to the instrument status. Upon pressing the displayed button, detailed information of the relevant status appears.

See “■ Information button” on page 1-10.

## 15.7 Calibration and Commissioning

Allows you to calibrate and configure the instrument. These operations can be protected with a password.

For details on the password, refer to section 16.6.3.

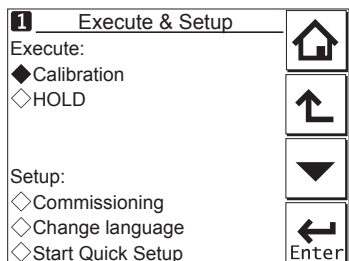





Figure 15.12 Execute & Setup

Pressing  changes the display to the Execute & Setup screen.



---

Browse through the menu items by pressing  until you find the desired menu and then press  to enter that menu. It is also possible to enter a desired menu by pressing the ◇ symbol beside the menu item.

For calibration (HOLD), read chapter 17, and for commissioning, read chapter 16.

# 16. COMMISSIONING OF SENCOM pH/ORP

This chapter describes how to check and change settings from the Commissioning screen. When you move to the Commissioning screen, the output is held.

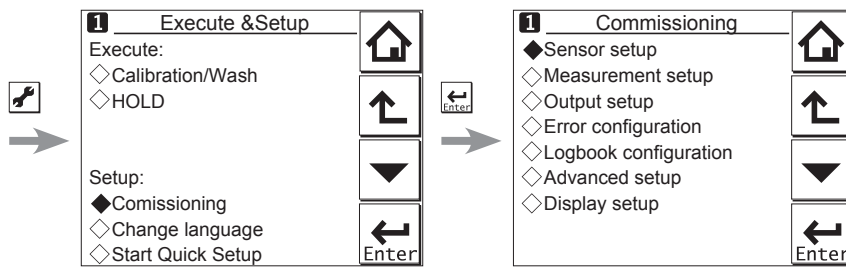

Figure 16.1 Commissioning screen

Operations in Commissioning can be password-protected. If you set up a password, always take a note of it. For details on setting a password, see section 16.6.3.

Figure 15.1 shows the commissioning procedure. Before changing any parameters, read the relevant sections in this document and understand how the change of parameters affects the performance of this instrument. If you set a wrong value, return it to the default setting or value and then set it again.

On the first startup, the parameters are all default values configured at the factory. Check the parameters in Table 16.1 and change any of them if necessary depending on the sensors to be connected and the purpose of use.

Set "Sensor type" first. Some measurement parameters and relevant options change accordingly. The underlined parameters in Table 16.1 are used for the quick setup.

The default values and setting ranges are listed in the "User setting table of SENCOM" in the attached CD-ROM.

After confirming that the instrument operates normally with the parameters, print out the "User setting table of SENCOM" and write down these parameters in the column of User Settings.

All user parameters can also be saved in the instrument.

Select Commissioning → Advanced setup → Settings → Save user settings (see Section 16.6.1).

**Table 16.1 Menu Structure and Default Values in “Commissioning”**

Parameter		Ref. sect.		
Sensor setup	<u>Sensor type</u>	16.1		
Measurement setup	<u>Measurement</u>	16.2.1		
	Temperature setting	<u>Temp. element</u>	16.2.2	
	Temp. compensation	Compensation	16.2.3	
		Reference temp.		
		Process Temp. Compensation		
	Calibration settings	pH settings	Zero and Slope units	16.2.4
			Limits and timing	
			Buffers (select set)	
			Zero/Slope/ITP	
			Auto correct (Zero, Slope)	
		ORP settings	Limit and timing	
		rH settings	Zero/Slope	
	Impedance settings		16.2.5	
	Concentration	Unit	16.2.6	
Sensor diag. settings	Input 1 imp.:	16.2.7		
	FINE			
	Input 2 imp.:			
	Process time			
	Heat cycle:			
	Define heat cycle			
	Define SENCOM status			
Output setup	mA	Output	<u>Process parameter</u>	16.3
			Setup	
		Linear	<u>0 % value</u>	
			<u>100% value</u>	
		Table		
		Burn		
		Damping time		
	Simulate	Simulation perc.		
Configure Hold				
Error configuration		16.4		
Logbook configuration		16.5		
Advanced setup	Settings	16.6.1		
	Tag	16.6.2		
	Passwords	16.6.3		
	Date/Time	16.6.4		
	Communication	HART	16.6.5	
		PH201G		
	Factory setup	16.6.6		
Display setup	Main display	16.7.1		
	Trend	16.7.2		
	Auto Return	16.7.3		
	Adjust contrast	16.7.4		
	MONITOR display	16.7.5		

**NOTE**

All the parameters for the quick setup (underlined ones in Table 16.1) are crucial for measurement. If you change any of them, other parameters may be initialized. For the parameters that may initialize other values, see Appendix 1.

# 16.1 Sensor setup

“Sensor type” setup is determined by the sensor to be connected to the instrument. Select one of the following three sensor types:

- pH: Only pH is measured.
- ORP: Only ORP is measured. Use this setting for the ORP measurement on the basis of a glass electrode. For the measurement on the basis of a reference electrode, select pH+ORP and then select ORP in [Measurement].
- pH + ORP: Both pH and ORP are measured simultaneously. This setup also allows rH to be measured. ORP measurement is based on a reference electrode

**Table 16.2** Selecting sensor types

Sensor type	Measurement (Sec. 16.2.1)	Description
pH + ORP	pH	For the ORP measurement on the basis of a reference electrode
	ORP	
	pH + ORP	
	pH + rH	
	rH	
pH	(not displayed)	Same of pH of “pH + ORP”
ORP	(not displayed)	For the ORP measurement on the basis of a glass electrode

## NOTE

The default of [Sensor type] is pH+ORP. Change this setting for your sensors. Not all sensor types are available for some SENCOM sensors. For example, pH cannot be selected when an ORP sensor is connected.

## NOTE

The selection of “Sensor type” determines the menu structure throughout the instrument.

When pH + ORP is specified as the sensor type, the object under measurement will be displayed at the top of “Measurement setup.”

If the sensor type is changed from pH to ORP, part of the relevant setup is reset, requiring reconfiguration.

When ORP is specified, and when an ORP sensor doesn’t have any temperature element, set both of “Temperature too high/low” in “Error configuration” to Off so that no related error is caused. (Refer to the section 16.4.) Without temperature input, a temperature shown on the Main display is the maximum or the minimum temperature of the temperature element’s range set on the Temperature settings. Setting in “Display setup” can make temperature value on the display not to be displayed. (Refer to the section 16.7.)

## 16.2 Measurement setup

This section describes how to set up various parameters relating to measurements.

Measurements are performed based on the measurement parameter setup.

For measurement setup, part of the menu structure of settable items changes depending on the "Sensor type" selected in "16.1 Sensor setup."

### 16.2.1 Measurement

If pH or ORP is selected in "Sensor type," a measurement type does not need to be selected and it is not displayed.

If "pH + ORP" is selected in "Sensor type," five measurement types can be selected for the "Measurement" item at the top of the Measurement setup screen. Select a suitable measurement type for the application.

Moreover, associated items are added to parameters in "Error configuration," "Display setup," etc.; check the setting condition of each item.

### 16.2.2 Temperature settings

When SENCOM sensors are connected, temperature elements for compensation are automatically set.

Celsius (°C) or Fahrenheit (°F) temperature units are available. If the unit is changed, the following values are also recalculated automatically to the new unit:

- Manual temp.
- Reference temp.
- Temp. coefficient
- Temp. ranges in the matrix

### 16.2.3 Temperature compensation

ORP measurement involves no temperature input. No setting is required on the temperature compensation. Process temperature compensation is effective if "T.C. ORP mV/°C" in "Temp. Coef." is set.

#### ■ Temperature compensation

This compensation of pH value is performed on the Nernst equation.

Two methods can be used: Automatic and Manual. Select Automatic when a temperature element is used, or select Manual when a manually set temperature is used.

#### NOTE

When Manual is selected on the Temperature compensation, a process temperature should be set in the "Manual temp." A temperature shown on the Main display is this manually set temperature.

#### ■ Reference temperature

Set a reference temperature to which the measured pH value must be compensated. Normally 25°C is used, so this temperature is chosen as the default value.

## ■ Process temperature compensation

Select a temperature compensation method. "None" does not perform the temperature compensation.

If "pH" is selected in "Sensor type," choose process temperature compensation from among None, TC, Matrix, and NEN6411. If "ORP" is selected in "Sensor type," choose it from among None and TC.

### ● TC

This method uses the linear compensation function.

It is possible to adjust the temperature coefficient (TC) factor directly. If the temperature coefficient factor of the sample liquid is known from laboratory experiments or has been previously determined, it can be entered here.

This TC is a pH variation to 1 °C ( $\Delta\text{pH}/\Delta T$ ). Adjust the value between -0.1 to 0.1 pH/°C.

In combination with the reference temperature setting, a linear compensation function is obtained, which is suitable for all kinds of chemical solutions.

### ● Matrix

Matrix means a temperature compensation which uses the temperature compensation matrix. The temperature compensation matrix is a table of pH values at various temperatures corresponding to the pH values at the standard temperature. For details, see Appendix 1.

When the temperature or the precompensated pH value is out of the range of the temperature compensation matrix, the temperature compensation error (warning) will be issued. This is not a device error.

In this case, however, the temperature compensation is performed by extrapolation.

## NOTE

To display the precompensated pH value, set the Process Temp. Compensation to "None".  
Select Measurement setup → Temp. compensation → Process Temp. Compensation.

### ● NEN6411

This algorithm takes into account the dissociation of water in strong acid and strong alkaline solutions. It is particularly useful for pH measurement of boiler feed water.

## 16.2.4 Calibration settings

The screen flow differs depending on the combination of objects to be measured.

Calibration settings for a pH converter involve slope (sensitivity), zero (aspot), and ITP (isothermal point). Figure 16.2 shows the pH value against the mV output of the sensor. The characteristic for pH measurement is an offset also known as aspot [mV] or zero [pH] and a Slope [%, mV/pH]. For an ideal sensor, the theoretical slope is 59.16 mV/pH at 25°C. The slope can be entered in mV/pH or as a percentage of the theoretical slope (100% corresponds to 59.16 mV/pH). ITP represents a pH value where the output of the sensor does not change with temperature. Note that slope and zero are defined at 25°C.

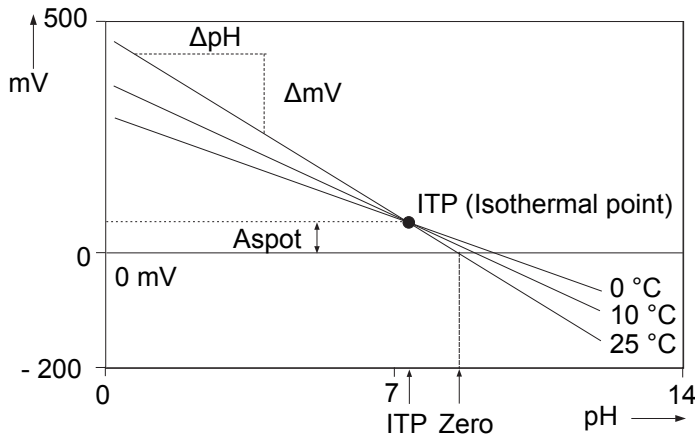

Figure 16.2 Calibration parameters

### ■ pH settings

- **Zero and Slope units**

Zero is an alternative to Asymmetry Potential. The method of zero (aspot) unit conforms to the DIN standard for IEC 60746-2 instruments. Zero is defined in pH or mV.

The unit of Slope (sensitivity) is mV/pH or % (with the theoretical value as 100%).

- **Limits and timing**

#### **Zero High/Low**

Zero (aspot) high and low limits. During calibration, it is checked whether the new zero exceeds these high and low limits. Narrowing the band will prevent bad calibration procedures and calibration of bad sensors, resulting in higher accuracy. The default values should be adjusted to suit the application and the “users” criterion.

#### **Slope High/Low**

Slope (sensitivity) high and low limits. During calibration, it is checked whether the new slope exceeds these high and low limits. Narrowing the band will prevent bad calibration procedures and calibration of bad sensors, resulting in higher accuracy. The default values should be adjusted to suit the application and the “users” criterion.

#### **Step Range**

Set the range over which the stability of a measured value is checked. If variations of a measured value over the stabilization time are within this setpoint, the measured value is judged to have stabilized.

**Stabilization time**

This is the time over which the stability of a pH value is monitored during calibration. When variations of the pH value are within a value set in Step Range over this stabilization time set here, the value is regarded as being stable. If the pH value does not stabilize within 10 minutes, calibration is aborted.

**Calibr. interval**

Set the interval in which a new calibration must take place. If the interval set here is exceeded, the instrument will give a warning or fault according to the setting on the Error configuration screen.

**● Buffers (select set)**

Calibration is made using standard calibration buffers. We recommend the NIST (JIS equivalent) standard buffers for highest accuracy, but the user is free to select DIN 19267, US, or a user-defined buffer. The standard buffers can be found in Appendix 1.

Three types of user-defined buffer tables can be defined. On the Free programmable screen, select a buffer table that you wish to set up. When a buffer table is selected on this screen, the Buffer table 1 to Buffer table 3 screens of the selected buffer table are displayed.

**Clear table?**

If you select “Yes” and press “Yes” when prompted to clear the table, the contents of the buffer table will be cleared, the display will return to the Buffer table screen automatically, and the “Table was cleared” message will be displayed. If you want to perform temperature compensation using the matrix after clearing the table, matrix values must be redefined.

**Check values?**

If you select “Yes,” a value check starts. When the check ends, the results will be displayed on the screen. When the results are normal, the “No error” message appears. In case of an error, error information is displayed.

**● Zero/Slope/ITP**

You can enter Zero (aspot), Slope (sensitivity), and ITP values directly in the screen displayed. These data can be obtained from the manufacturer of the probe, by the users laboratory, etc.

**NOTE**

It is not necessary to enter this data. In most cases, as the FLXA202/FLXA21 automatically does this while performing calibration, the feature is used in the case of special electrode systems or where calibration in the process environment is not possible. See Chapter 17.

**● Auto correct (Zero, Slope)**

This function calculates calibration coefficients from the transition of past calibration data (zero, slope) and compensates pH value using these calibration coefficients after the latest calibration. The default setting is “Disable.” To make the function effective, select “Enable.”



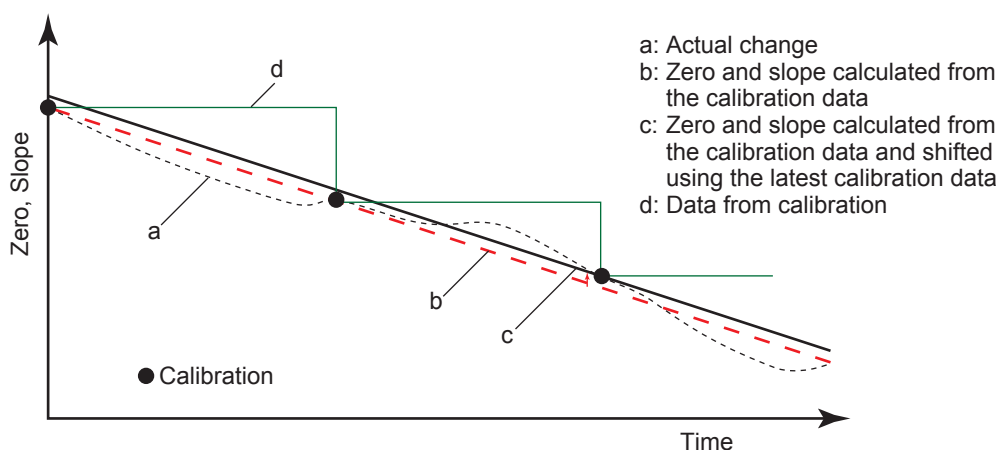

Figure 16.3 Auto correct

## ■ ORP settings

### ● Limits and timing

#### Zero High/Low

Zero (aspot) high and low limits. During calibration, it is checked whether the new zero exceeds these high and low limits. Narrowing the band will prevent bad calibration procedures and calibration of bad sensors, resulting in higher accuracy. The default values should be adjusted to suit the application and the “users” criterion.

#### Slope High/Low

Slope (sensitivity) high and low limits. During calibration, it is checked whether the new slope exceeds these high and low limits. Narrowing the band will prevent bad calibration procedures and calibration of bad sensors, resulting in higher accuracy. The default values should be adjusted to suit the application and the “users” criterion.

#### Step Range

Set the range over which the stability of a measured value is checked. If variations of a measured value over the stabilization time are within this setpoint, the measured value is judged to have stabilized.

#### Stabilization time

This is the time over which the stability of an ORP value is monitored during calibration. When variations of the ORP value are within the value set in Step Range over this stabilization time set here, the value is regarded as being stable. If the value has not stabilized within 10 minutes, calibration is aborted.

#### Calibr. interval

Set the interval in which a new calibration must take place. If the interval set here is exceeded, the instrument will give a warning or fault according to the setting on the Error configuration screen.

### ● Zero/Slope

You can enter zero and slope values directly.

## 16.2.5 Impedance settings

This screen is used to set the impedance relating to an input impedance check.

“High” or “Low” is automatically set according to the connected SENCOM sensor. You cannot select the setting. In the case of “Low”, high and low limits can be set.

For FU20F sensors, Impedance 1 is “High” and Impedance 2 is “Low”.

Input 1 impedance represents the “glass membrane impedance” of a pH sensor. In case of an ORP sensor, it represents “metal electrode impedance.” Input 2 impedance stands for “reference impedance.”

The FLXA202/FLXA21 has an impedance check, which is capable of monitoring the impedance of various sensor systems.

The system can be set to measure the impedances of glass (input 1 impedance: high) and reference (input 2 impedance: low) electrodes. In applications that tend to leave deposits on the electrodes or to clog the reference sensor junction, the impedance check (set error configuration) on the reference sensor can be used to initiate an alarm, or to initiate the wash cleaning process, if one of the limits is exceeded.

## 16.2.6 Concentration

Generally pH values are not converted into concentrations. Following linear conversion is not suitable for a lot of measurements.

The FLXA202/FLXA21 is capable of converting a measured pH value into concentration for display. Parameters required for concentration calculation can be arbitrarily set by the user. Those parameters are as follows:

Unit: The default value is %. The unit can be selected from among mg/L, g/L, and ppm.

pH: The default values are 0 and 14 pH (0 to 14). They are the pH zero and span required for conversion to concentration.

Concentration: The default value are 0 and 100%. Concentration for each pH can be set.

Concentration can be assigned to the pH value zero and span individually.

## 16.2.7 Sensor diagnostic settings

This screen is used to set items relating to sensor diagnostics displayed on the screens invoked

by pressing .

Gauges are displayed for only parameters that have been enabled in “Sensor diag. settings.”

Parameters set to Disable are provided with a bar display.

The setting parameters include Input 1 imp., Input 2 imp., Progress time, and Heat cycle.

When input impedance is set “High” (section 16.2.5), “FINE” value can be changed. When input impedance is set “Low”, its “High limit” and “Low limit” will be the limits for diagnostic.

For FU20F sensors, Impedance 1 is “High” and Impedance 2 is “Low”.

It is also possible to set the “Bad limits” of the progress time and heat cycle and the “Heat cycle temp” and “Heat cycle time” of the heat cycle.

- **Define SENCOM status**

Set the parameters for analyzing the SENCOM sensor. They are displayed on the detail screen. The parameters are Sterilized temp., Sterilized time, High temp.1, High temp.2, Low pH value, and High pH value.

## 16.3 Output setup

The general procedure is to first define the function of the output, Output or Simulate. Then, set the process parameters associated with the output. On the Output, an output of measured value is selected. On the Simulate, a simulation value can be set.

And, the parameters for HOLD function can be set on this setting.

- **Output**

The output signal is a current value specified by the following parameters.

### Process parameter

The available process parameters depend on the selected "Sensor type" on the Sensor setup and the selected "Measurement" type on the Measurement setup.

The output of the selected process parameter is shown as a bar on the bottom of the Main display. And its parameter symbol (for example, PH1) is shown above the bar, too. When a selected process parameter is displayed as a measurement value, the top left number or character is turned to be white number or character on black background (for example, **PH1**). (Refer to the section 1.2.)

Process parameters can be selected from among:

pH1, Temperature 1, and ORP1:      SENCOM module's measured values

### Setup

Select one of the output methods: Linear and Table.

Linear:      Set the 0% and 100% values.

Table:      This allows the configuration of an output curve by 21 points (5% intervals).  
(The 0% and 100% values must be entered.)

### Burn

Select the designated output in case of a fault from among Off, Low, and High. See "16.4 Error configuration" to set the output.

Off:      Output depends on the measured value.

Low:      Output is fixed to 3.6 mA

High:      Output is fixed to 22.0 mA.

### Damping time

This is the time taken for a response to a step input change to reach 90% of the final value (attenuation time). Set this time in sec.

- **Simulate**

When this function is selected, an output of the instrument will be a fixed current value set in % of the output span. The output span range is -2.5% to 112.5% (3.6 mA to 22.0 mA).

When "Simulate" is selected, regardless of hold setting, the output is always simulated value.

## ■ Configure Hold

On the Configure Hold, settings are performed to hold of the mA output at a preset value. (Refer to the section 17.4.) This is enabled only if “mA” is “Output.”

During the Commissioning or the Quick Setup, the mA output is automatically held. The preset value depends on a setting on the “Last or fixed”.

“Last”: The preset value is a value measured just before hold condition.

“Fixed”: The preset value is a value set in the “Fixed value mA”.

When the “Fixed” is selected, set a mA value in the “Fixed value mA”.

Selection on the “Hold during Calibration/Wash” decides to activate or deactivate the hold function automatically during calibration or wash.

“Enabled”: Activation of the automatic hold function

“Disabled”: No automatic hold function

Only when the “PH201G” is selected on the Communication, the message of “Hold during Calibration/Wash” is displayed. On other selections, the message of “Hold during Calibration” is displayed.

## 16.4 Error configuration

In Error configuration, configure the statuses of various error causes.

This allows the system to notify the user of the occurrence of an error according to the status categories in the Error configuration.

Select a status category from among Off, Warn. (Warning), and Fault.

“Fault” automatically performs burn-out. When Burn has been set to Off (16.3 Output setup), only the error message is displayed.

“Warn.” displays an error message.

When selecting PH201G in the communication setting, make sure that the “Fail contact” setting is appropriate.

The settable causes of errors are determined based on the settings of the Sensor setup and Measurement setup, and a status category is set to the causes displayed in the Errors 1/3 to 3/3 screens.

**Table 16.3** Error configuration

Display item	Description	Default
pH too high	The pH value exceeds 16.00.	Warn.
pH too low	The pH value is lower than -2.00.	Warn.
Temperature too high	Measured process temperature is higher than the maximum limit.	Warn.
Temperature too low	Measured process temperature is lower than the minimum limit.	Warn.
ORP too high	The ORP value is higher than 1500 mV.	Off
ORP too low	The ORP value is lower than -1500 mV.	Off
rH too high	The rH value is higher than 100.	Off
rH too low	The rH value is lower than 0.	Off
Matrix config. error	The temperature compensation matrix is not set properly (see Section 16.2.3).	Fault
Calib. time exceeded	Calibration time exceeds the calibration interval (see Section 16.2.4).	Off
Wash half-time error	The response to wash is abnormal.	Off
Impedance 1 too high	The sensor must be checked.	Off
Impedance 1 too low		
Impedance 2 too high		
Impedance 2 too low		
SENCOM changed	The SENCOM sensor has been changed. This error setting can be set to either Off or Warn..	Warn.

## CAUTION

If canceling an error configuration could be risky, do not cancel it as a dangerous situation may result.

## NOTE

The “Impedance 1 too high/too low” and “Impedance 2 too high/too low” error items are displayed in the Error configuration screen. In general, for a pH sensor, “Impedance 1” means “glass electrode,” and for an ORP sensor, it means “metal electrode.” “Impedance 2” represents the reference electrode in all cases.

## NOTE

Before using sensors which do not have any temperature measuring elements, set both of “Temperature too high” and “Temperature too low” to Off on the “Error setting” screen. Due to the open input of temperature signal, a false error may happen as if temperature goes over a high limit or a low limit.

## 16.5 Logbook configuration

In “Logbook configuration,” the user configures information to be saved to a logbook or initializes the logbooks.

Logbooks are used to keep an electronic record of events such as error messages, calibrations, and programmed data changes. By referring to this log, users can, for instance, easily determine maintenance or replacement schedules.

In “Logbook configuration,” the user can select “Off,” “1-1,” or “1-2” for each item of interest to be logged.

The SENCOM logbook cannot be specified.

This can be done for items displayed on the Settings logbook 1/3 to 3/3 screens. Assigning 1-1 or 1-2 to each item allows information to be organized and logged in a logbook.

## NOTE

Some events such as power-on are saved into the logbook “1-1”. This logbook may be full earlier. It is recommended that important information be saved into the logbook “1-2”.

16

For “Erase logbook”, a specified logbook “1-1”, “1-2” or “SENCOM” can be erased individually.

When the “Warn if logbook full” is set to “Yes”, a warning is given when the logbook come to near full (up to 3 pages for the SENCOM logbook, up to 13 pages for others).

## NOTE

When the logbook gets full, the oldest information is erased automatically.

## 16.6 Advanced setup

Advanced setup is used to set functions relating to matters other than measurements such as the selection of settings, tag setting, password setting for protecting calibration and commissioning operations, date setting, and communication setting.

(“Factory setup” is for service engineers only; there is no item to be set by the user.)

### 16.6.1 Settings

In “Settings,” select an item to be set as the default value from among “No action,” “Load factory settings,” “Save user settings,” and “Load user settings.”

When the default values are loaded, the instrument will be restarted. (In the case of “Save user settings,” it will not be restarted.)

The following parameters are not included in the defaults:

- Tag
- The contents of all logbooks

## NOTE

When the “Save user setting” is only selected, save of the user-set parameters will start at once.



To avoid wrong selection, operation in this Settings must be done by , not by touching the menu message.

SENCOM

If you select “Load factory settings,” the instrument will be set to the default settings at factory shipment.

When this item is selected, a screen prompting whether to restart is displayed. If this is no problem, press “Yes.” Then the “Loading ...” message appears and blinks and loading is started. When the factory settings have been loaded, the instrument will be restarted.

When “Save user settings” is selected, the current settings can be saved as the defaults. When this item is selected, the user settings will start to be saved immediately. After saving the

parameters, press  or  to change the display because this save doesn't have restart function.

If “Load user settings” is selected, the settings saved as user settings can be set as the defaults.

When this item is selected, a screen prompting whether to restart is displayed. If this is no problem, press “Yes.” Then the “Loading ...” message appears and blinks and loading is started. When the user settings have been loaded, the instrument will be restarted.

## 16.6.2 Tag

A tag provides a symbolic reference to an instrument and is generally defined to be unique throughout the control system at one plant site. A tag can contain up to 12 alphanumeric characters. The default value is SENCOM.

The tag is displayed at the top of the main display.

## 16.6.3 Passwords

Calibration and commissioning operations can be separately protected by each password. To protect execute operations, enter a password in Execute's input field. To protect commissioning operations, enter a password in Commissioning's input field. By default, both input fields are empty. When a password input field is empty, operation is not password-protected. A password can contain up to 8 characters.

When you set a password, always take a note of it.

When a password is set, input of the password is necessary to enter the password-protected operation. After inputting the password, the display will change to an operator ID input display. When an operator ID is input, its operation is recorded into a logbook. The input of an operator ID is not necessary to enter the operation. An operator ID can contain up to 4 characters.

## 16.6.4 Date/Time

The Logbooks and trend graphs use the clock/calendar as a reference. The current date and time is set here. The time display format can be selected from among three types.

## 16.6.5 Communication

In “Communication,” select the communication setting from among None, HART, and PH201G. The burn down current value is 3.6 mA.

### NOTE

---

To make the change of “Communication” valid, turn off the power supply once, and reboot.

---

In the case of “None,” there is not the problem even if you do not change it as “HART” of default value.

## ■ HART

Select this menu when HART communication (HART 5) is made.

In the HART setup screen, specify the network address and set up parameters for SV, TV, and FV.

(PV is linked with the “process parameter” setting in “Output settings” and cannot be changed here.)

### ● Network address

For 1-to-1 communication, leave the default value [0] unchanged. For multi-drop where multiple HART devices are connected on a bus, set addresses in 1 to 15. In this case, the mA output will be fixed to 4 mA.

### ● PV

PV is a parameter selected for analog output; it cannot be changed here.

### ● SV, TV, FV

The SV, TV, and FV parameters are items that the user must set up. Selectable items differ depending on the sensor type in “Sensor setup” and settings in “Measurement setup.”

If blank is selected for a parameter, items below that parameter must all be set to blank. If an item is blank, those below it cannot be set to a status other than blank.

For more information on HART communication, see the Technical Information (TI 12A01A02-60E) in the attached CD-ROM.

## ■ PH201G

Select this menu if the PH201G distributor is connected to the instrument.

In the PH201G setup screen, make settings for “Hold contact,” “Fail contact,” and “Wash contact.”

### ● Hold contact

Select Disabled or Enabled.

When this item is enabled, the output will be held according to the setting of “Hold type” on the Hold setup screen.

### ● Fail contact

Select a status from among “Fail + Warn,” “Fail only,” and “Disabled.”

This setting depends on the error configuration. See “16.4 Error configuration.”

“Fail” corresponds to “Fault.”

### ● Wash contact

Select Disabled or Enabled.

When this item is enabled, items for a wash can be set on the Wash settings screen.

In the Wash settings screen, set the interval time, wash time, and recovery time and setup of various washes.

Interval time:      Set the wash interval in hours.



- Wash time/measure time: Set the wash time in minutes. In a continuous wash, wash time is replaced by measure time.
- Recovery time: Set the recovery time in minutes.
- Manual wash: Select "Disabled" or "Enabled."  
When this item is enabled, a wash cycle can be activated manually. On the Calibration/Wash screen, press the "Start manual wash cycle" to perform a manual wash.
- Imp2 wash: Select "Disabled" or "Enabled."  
When this item is enabled, a wash cycle can be started if the "Impedance 2 too high" error occurs with respect to the reference electrode.
- Continuous wash: Select "Disabled" or "Enabled."  
A continuous wash cycle is started at the instant when this item is enabled. In a continuous wash, the "Measure time" and "Interval time" are reversed (see Figure 16.4).

When a continuous wash is disabled

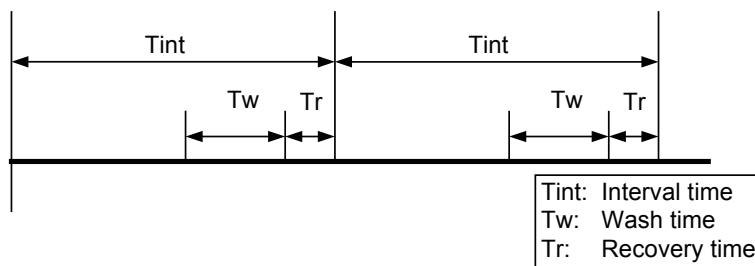

When a continuous wash is enabled

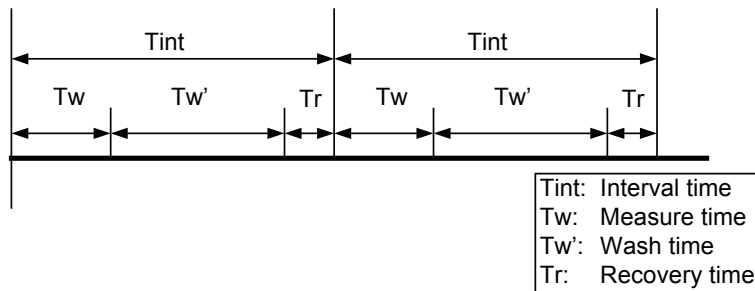

F050605\_2.ai

Figure 16.4

The instrument has a function for checking whether measurements are normally made after wash, allowing you to check a sensor response.

The wash recovery check is performed by making use of the time to recover half the wash-cycle pH change. The half the wash-cycle pH change recovery time replaces the relaxation time by the recovery time.

Whether to conduct the wash recovery check can be set on the Error settings 2/3 screen. Half the wash-cycle pH change refers to half the value ( $1/2\Delta\text{pH}$ ) of the difference ( $\Delta\text{pH}$ ) between the pH value during normal measurement of an example in Figure 16.5 and the pH value detected during wash. If the pH value during wash is greater than  $1/2\Delta\text{pH}$  when  $1/3 t_R$  has elapsed, the electrode is assumed to be good. If it is smaller than  $1/2\Delta\text{pH}$ , then the electrode is assumed to be bad.

However, for applications where the pH during wash shows almost the same value as the normal pH, the difference will be approximately zero. In such a case, disable the wash recovery check. An example of such applications is the monitoring of waste water pH. If you select water jet cleaning in such a case, the normal pH as well as the washing time pH will be around pH 7; the difference will be approximately zero, so the recovery time check will not work normally.

This function is available either for ORP measurement only.

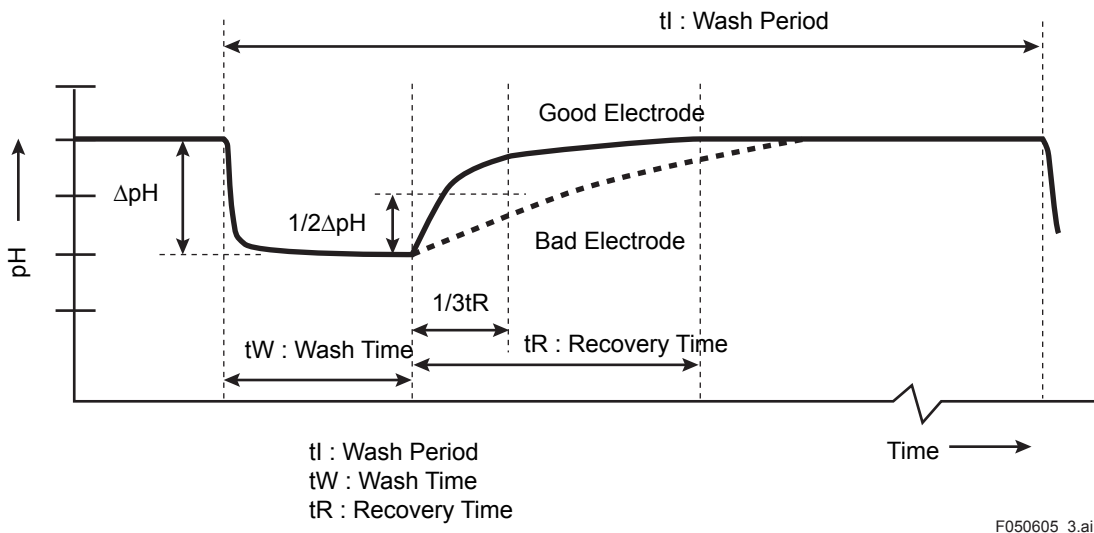

Figure 16.5

### 16.6.6 Factory setup

For “Factory setup,” there is no item to be set by the user.

#### NOTE

This menu is for service engineers only. This section is protected by a password. Attempting to change data in the factory adjustment menu without the proper instructions and equipment could result in corruption of the instrument setup and damage the performance of the unit.

### 16.7 Display setup

This screen is used to make various settings relating to screen display.

#### NOTE

Settable items differ depending on settings in “Sensor setup” and “Measurement setup.”

#### 16.7.1 Main display

Three measurement values can be set to display on the Main display as a primary value (1st line), a second value (2nd line) and a third value (3rd line) respectively.

On the “Additional text”, a text of up to 12 alphanumeric characters can be assigned to each measurement value.

Additional texts are displayed on the Main display, and are useful for identifying measurements. In some cases, not all 12 characters can be displayed due to the letters; check the texts displayed on the Main display after setting. If a part of the text is missing, adjust the number of characters.

## 16.7.2 Trend

This screen is used to make settings for the Trend Graph Screen.

Set the process parameters to be displayed for each trend. They can be set for the 1st to 3rd trends. When all three process parameters are set “Empty”, there is no trend display (no trend button).

- **X-axis: Timing**

Select the X-axis timing's time span on the trend graph display from a list.

- **Y-axis: Limits**

Set the Y-axis high and low limits on the trend graph display on a Trend screen basis.

### **NOTE**

---

Updating the trend display setup resets the current trend graph and starts a new one.

---

## 16.7.3 Auto Return

When no operation is performed for the time set in “Auto Return”, the display returns to the Monitor display (or to the Main display when the MONITOR display is disabled) and the analyzer returns to a normal measuring mode. (When the Trend display is selected, the Auto Return doesn't work.)

Select the time from among Disable, 10 min, and 60 min. When the Auto Return function is not used, select “Disable.”

### **NOTE**

---

A default is “10 min”. When maintenance like a calibration that may take much time is performed, “60 min” or “Disable” is recommended to be selected.

---

## 16.7.4 Adjust contrast

The LCD screen contrast can be adjusted.

Pressing the ▲ ▼ keys adjusts the contrast in 11 levels from +5 to –5 (including the default value of “0”).

## 16.7.5 MONITOR display

Select “Enable” so that the Monitor display becomes available. A default is “Enable”.

During Hold/Wash condition and a warning/fault condition, the Main display is displayed to indicate the condition.

# 17. CALIBRATION OF SENCOM pH/ORP

The FLXA202/FLXA21 checks the status of sensors including the connection.

While an error is issued, calibration cannot be performed.

## NOTE

Do not disconnect the sensor during calibration.

Before pH measurement, calibrate the pH sensor with the standard solution.

Before ORP measurement, check the electrode as a part of regular maintenance.

## NOTE

A default is “10 min” for “Auto Return”. When maintenance like a calibration that may take much time is performed, “60 min” or “Disable” is recommended to be selected. (Refer to the section 16.7.3.)

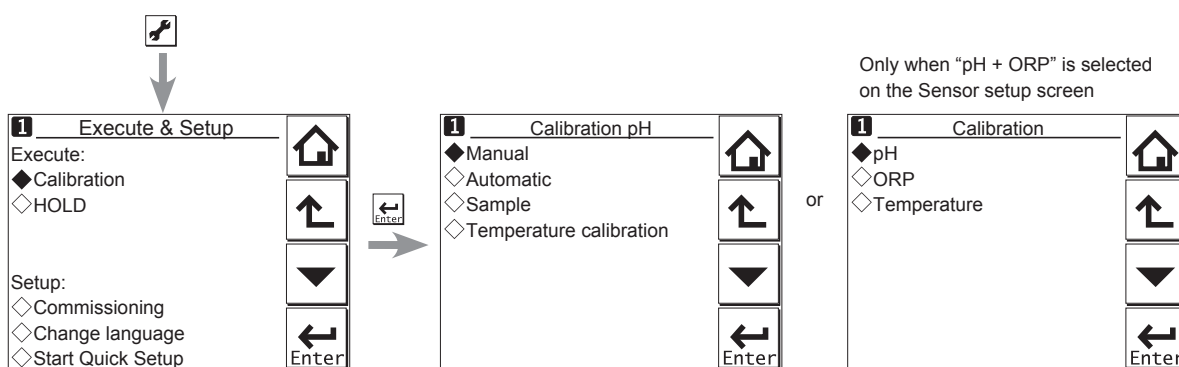

**Figure 17.1 Calibration**

The calibration items include pH, ORP, rH, and Temperature.

The item to be calibrated is determined according to the settings made in the Sensor setup and Measurement setup in Commissioning.

Press  to select Execute: Calibration, choose the item to be calibrated, configure the calibration settings, then perform calibration.

## NOTE

Note the following when performing calibration with buffer solutions.

1. Before starting a calibration, make sure the electrode system is properly cleaned and the electrodes are fully functional. They must then be rinsed with clean water to avoid contamination of the calibration solution(s).
2. Always use fresh buffer solution to avoid the risk of introducing errors from contaminated or old solutions. Buffers supplied as liquids have a limited shelf life, especially alkaline buffers, which absorb CO<sub>2</sub> from the air.
3. Yokogawa strongly recommends NIST/DIN 19266 buffer standards for the best accuracy and buffer capacity. Commercially adjusted buffers (e.g., pH 7.00, 9.00 or 10.00) are a compromise as a standard, and are often supplied without a temperature dependency curve. Their stability will never be as good as NIST (JIS equivalent) solutions.

Always ensure that the sensors are properly conditioned, clean and filled with the correct electrolyte solution (if appropriate) before starting a calibration. Refer to the sensor instructions for details.

## 17.1 pH calibration

There are the Manual, Automatic, and Sample modes of pH calibration.

### 17.1.1 Manual calibration

The unit is adjusted to match the value of the buffer standards or a process solution with a known pH value (buffer solution).

The user determines the pH value, temperature influence, and stability.

Select the calibration type from among [zero/slope], [zero/slope/ITP(3point)], and [zero/slope1,2 (3point)].

Calibration is performed stepwise; follow the prompts displayed on the screen.

A stability check is conducted at each measurement point. Proceed to the next step only after the reading has stabilized.

At calibration, we advise leaving the sensors for three to five minutes in the buffer solution before proceeding to the next step even when the reading has stabilized. This will give reliable and accurate calibration results.

#### NOTE

When a sensor or an electrode is exchanged or replaced, sensor wellness data should be reset.

When a sensor is replaced, the replacement can be recorded manually into a logbook. (Refer to the figure 15.11.)

#### ● zero/slope

This calibration type is one-point or two-point calibration.

One-point calibration performs the zero adjustment only. Two-point calibration performs the zero and slope adjustments.

#### ● zero/slope/ITP(3point)

This calibration type is ITP-type three-point calibration.

If ITP does not have pH 7, three-point calibration is performed to obtain the zero (asymmetry), slope (sensitivity), and ITP (isothermal point) for calibration.

#### Limitations

- Three different buffer solutions whose difference in pH value between buffer solutions is 1 pH or more should be used.  
(1st buffer < 2nd buffer < 3rd buffer or 1st buffer > 2nd buffer > 3rd buffer)
- The 2nd buffer solution should be pH  $7 \pm 2$ .
- The temperature difference between the 2nd and 3rd buffer solutions should be 5°C or less. The temperatures of the 2nd and 3rd buffer solutions should be at least 20°C higher or lower than the temperature of the 1st buffer solution.
- To calculate the pH value of the 3rd buffer solution ( $\text{pH}_{3\text{cal}}$ ), insert the pH and temperature values of the 1st and 2nd buffer solutions and the temperature value of the 3rd buffer solution into the following equation.

$$\text{pH}_{3\text{cal}} = \text{ITP} - \frac{\left( \frac{t_3 - t_1}{t_2 - t_1} (273.15 + t_2)(\text{ITP} - \text{pH}_2) + \left(1 - \frac{t_3 - t_1}{t_2 - t_1}\right) \times (273.15 + t_1)(\text{ITP} - \text{pH}_1) \right)}{(273.15 + t_3)}$$

$\text{pH}_n$ : pH value of n-th buffer solution

$T_n$ : Temperature of n-th buffer solution (°C)

ITP: ITP value displayed in calibration settings (see section 16.2.4)  
Assign 7.00 as the ITP value when a specific value is not available or for the first calibration of a sensor.

Do not use the 3rd solution whose pH value is within  $\text{pH}_{3\text{cal}} \pm 1$ .

### ● zero/slope1,2(3point)

This calibration type is the line-segment type three-point calibration.

If the relation between electromotive force and pH is not in proportion for a wide range, divide the relevant range into two sections and obtain the zero (asymmetry) and slope (sensitivity) in each section to perform calibration.

#### Limitations

- Three different buffer solutions whose difference in pH value between buffer solutions is 1 pH or more should be used.  
(1st buffer < 2nd buffer < 3rd buffer or 1st buffer > 2nd buffer > 3rd buffer)
- The temperature difference between the 1st and 2nd buffer solutions should be 20°C or less.
- The temperature difference between the 2nd and 3rd buffer solutions should be 20°C or less.

## 17.1.2 Automatic calibration

Calibration can easily be performed by following the calibration menus.

Pre-select the buffer solution to be used from among NIST/DIN 19266, DIN 19267, US, and User defined buffer in Commissioning → Measurement setup → Calibration settings → pH settings → Buffers (select set). See also Appendix table 1.

If you select User defined buffer, calibration is performed based on the conditions registered in buffer tables 1 to 3. Use of the proper buffer table allows the system to perform reliable calibration.

In the same way as manual pH calibration, select the calibration type from among [zero/slope], [zero/slope/ITP(3point)], and [zero/slope1,2(3point)].

Calibration is performed stepwise; follow the prompts displayed on the screen.

A stability check is conducted at each measurement point. Proceed to the next step only after the reading has stabilized.

### NOTE

When a sensor or an electrode is exchanged or replaced, sensor wellness data should be reset.

When a sensor is replaced, the replacement can be recorded manually into a logbook. (Refer to the figure 15.11.)

● **zero/slope**

Select the solution that works with the “buffer solution” selected in calibration settings and perform calibration by following the prompts on the screen.

● **zero/slope/ITP(3point)**

Calibration is performed in the sequence of the sequence selection menu (Table 17.1) of the solution that works with the “buffer solution” selected in calibration settings. Perform calibration by following the prompts on the screen.

**Limitations**

- Three different buffer solutions whose difference in pH value between buffer solutions is 1 pH or more should be used.  
(1st buffer < 2nd buffer < 3rd buffer or 1st buffer > 2nd buffer > 3rd buffer)
- The 2nd buffer solution in the buffer table in the Free programmable screen should be pH 7 ± 2 (at 25°C).
- Either of the following conditions should be met.
  - The temperature difference between the 1st and 2nd buffer solutions should be 5°C or less. The temperature of the 1st and 2nd buffer solutions is at least 20°C higher or lower than the temperature of the 3rd buffer solution.
  - The temperature difference between the 2nd and 3rd buffer solutions should be 5°C or less. The temperature of the 2nd and 3rd buffer solutions is at least 20°C higher or lower than the temperature of the 1st buffer solution.

● **zero/slope1,2(3point)**

Calibration is performed in the sequence of the sequence selection menu (Table 17.1) of the solution that works with the “buffer solution” selected in calibration settings. Perform calibration by following the prompts on the screen.

**Limitations**

- Three different buffer solutions whose difference in pH value between buffer solutions is 1 pH or more should be used.  
(1st buffer < 2nd buffer < 3rd buffer or 1st buffer > 2nd buffer > 3rd buffer)
- The temperature difference between the 1st and 2nd buffer solutions should be 20°C or less.
- The temperature difference between the 2nd and 3rd buffer solutions should be 20°C or less.

**Table 17.1 Selection of Buffer Solutions in Three-point Calibration**

Buffer settings	Buffer sequence selection menus
NIST/DIN 19266	PH1.7→PH6.9→PH9.2
	PH4.0→PH6.9→PH9.2
	PH9.2→PH6.9→PH1.7
	PH9.2→PH6.9→PH4.0
DIN 19267	PH4.7→PH6.8→PH9.2
	PH9.2→PH6.8→PH4.7
US	PH4.0→PH7.0→PH10.0
	PH10.0→PH7.0→PH4.0
User defined buffer	table1→table2→table3
	able3→table2→table1

### 17.1.3 Sample calibration

A sample calibration is a single-point calibration for only the zero (asymmetric). It adjusts the recorded reading to a collected sample value. Press [Take Sample] to record a collected sample value in memory. Re-enter the Sample Cal. screen and press [Start calibration] to perform a sample calibration. This updates the recorded data.

#### NOTE

---

When a sensor or an electrode is exchanged or replaced, sensor wellness data should be reset. When a sensor is replaced, the replacement can be recorded manually into a logbook. (Refer to the figure 15.11.)

---

## 17.2 Temperature calibration

For the most accurate measurements, it is important to have a precise temperature measurement. Measure the temperature with a high-precision thermometer and adjust the sensor reading accordingly. For best accuracy, this should be done as near to the normal operating temperature as possible.

## 17.3 ORP calibration (rH calibration)

The calibration modes for ORP or rH are "Manual" and "Sample". No automatic calibration feature is available in an ORP or rH calibration.

Calibration is performed stepwise. Follow the prompts displayed on the screen.

A stability check is made at each measurement point. Proceed to the next step only after the reading has stabilized.

#### NOTE

---

When a sensor or an electrode is exchanged or replaced, sensor wellness data should be reset. When a sensor is replaced, the replacement can be recorded manually into a logbook. (Refer to the figure 15.11.)

---



## 17.4 HOLD

The FLXA202/FLXA21 has a function to hold the mA output at a preset value (default: "Last"). Use this menu to hold the output.

For the settings, see "■ Configure Hold" on page 16-11.

During commissioning or quick setup, the output is automatically held.

Setting "Hold during Calibration/Wash" to "Disabled" deactivates the hold function during calibration or washing.

Press  to select Execute: HOLD and then choose Manual Hold ON or Manual Hold OFF. This allows you to set up manual hold.

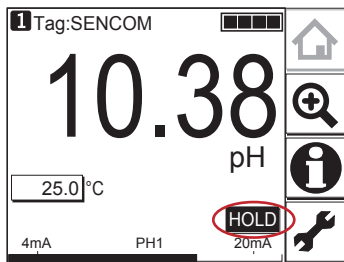

Figure 17.2 Example of the display with the manual hold enabled

To cancel manual hold, press the lit  section on the Main display.

# 18. MAINTENANCE

## ■ Periodic maintenance

The FLXA202/FLXA21 requires very little periodic maintenance, except to make sure the front window is kept clean in order to permit a clear view of the display and allow proper operation of the touchscreen. If the window becomes soiled, clean it using a soft damp cloth or soft tissue.

To deal with more stubborn stains, a neutral detergent may be used.

When you must open the front cover and/or glands, make sure that the seals are clean and correctly fitted when the unit is re-assembled in order to maintain the housing's weatherproof integrity against water and water vapor.

The pH measurement uses high impedance sensors and may otherwise be prone to problems caused by exposure of the circuitry to condensation.

### CAUTION

Never use harsh chemicals or solvents. In the event that the window does become heavily stained or scratched, refer to the parts list for replacement part numbers.

## ● Battery

The FLXA202/FLXA21 has a logbook feature that uses a clock to provide the timings. The instrument contains a lithium cell (battery) to continue the clock function while the power is turned off. Although the cell has an expected working life of 10 years, this is not guaranteed. When this cell needs replacing, contact your nearest Yokogawa service center.

## ■ Periodic maintenance of the sensor

Please follow the manual of each sensor about the maintenance of the sensor.

## ● Predictive maintenance

The FLXA202/FLXA21 has a unique prediction function (wellness check).



By making settings concerning the sensor wellness check, you can grasp the condition of the sensor in the gauge display in the Detail screen and carry out predictive maintenance.

See section 4.2.7, 7.1.7, 10.1.7, 13.2.7, or 16.2.7, Sensor diag. settings.



# 19. TROUBLESHOOTING



When a  or  indicator is displayed on the Main display, detailed error information can be given by pressing this indicator-button.

See “■ Information button” on page 1-10.

For setting of error items, refer to the Error configuration of the section 4.4, 7.3, 10.3, 13.4, or 16.4. For each error item, Warning or Fault will be indicated. Except these error items set on the Error configuration, some errors will be indicated.

## ■ Installation of sensor module

When a sensor module is not fixed properly, an error message on the figure 19.1 may be displayed. Check the sensor module installation and lock mechanism.

On a 2-sensor measurement, if the different type sensors (for example, pH and SC) are installed, an error message on the figure 19.2 will be displayed.

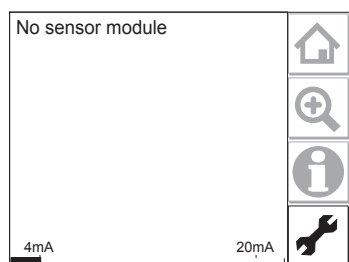

Figure 19.1 Error message when no sensor module is installed

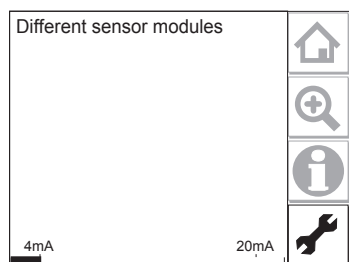

Figure 19.2 Error message for wrong combination of 2 sensor modules

19

PH

SC

ISC

DO

SENCOM

## ■ FLXA21 Replacement of Modules

Only authorized person of Yokogawa is allowed to replace modules.  
Be sure to keep the replacement procedure below.

### CAUTION

Turn off the power supply to the analyzer before replacement of modules.

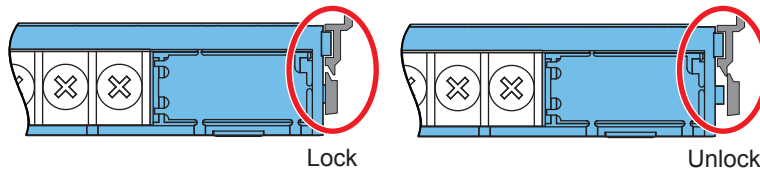

Figure 19.3 Locking the module

Do not hold the upper fine part when pulling out the module.  
First, unlock the module by releasing the lock mechanism on the left and right of the module.  
Use a slotted (flat head) screwdriver to pull-out the module. Before pull-out the module, loose a terminal screw to hook a screwdriver.

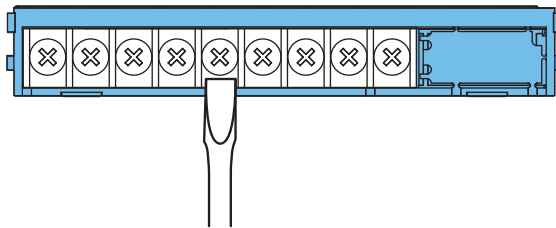

Figure 19.4 Pull-out the module

After replacement of modules, wire the sensor.

### NOTE

When the wiring of sensors is finished, be sure to attach the wiring covers. Furthermore, make sure the module is locked with the mechanisms on the left and right of the module.

### NOTE

Confirm that all locking-tabs (including for BLANK slots) are “Locked” position when close the front panel.

If locking-tabs are “Unlock” position, the front panel may be interfered with locking-tabs.

- **Checking nameplates of safety marking**

In case of Intrinsic safety type or type "n" or nonincendive model, confirm the name plate on the housing assembly and the sensor module. See "■ Mark position of explosion protected type" on page v.

**CAUTION**

---

Intrinsic safety type or type n or nonincendive housing assembly /sensor module are certified independently.

So they must be combined appropriately.

---

**CAUTION**

---

Don't use General Purpose housing assembly / sensor module as Intrinsic safety type module.

---



# Appendix 1 For pH/ORP

## ■ Buffer tables

The following tables show the details of the buffer solutions selectable in Calibration settings of pH (Section 4.2.4) (unit: pH).

**Table 1 NIST (IEC 60746-2)/DIN 19266**

	0°C	5°C	10°C	15°C	20°C	25°C	30°C	35°C	38°C	40°C	45°C	50°C	55°C	60°C	70°C	80°C	90°C	95°C
<b>1.68 pH</b>		1.668	1.670	1.672	1.675	1.679	1.683	1.688	1.691	1.694	1.700	1.707	1.715	1.723	1.743	1.766	1.792	1.806
<b>4.01 pH</b>	4.003	3.999	3.998	3.999	4.002	4.008	4.015	4.024	4.030	4.035	4.047	4.060	4.075	4.091	4.126	4.164	4.205	4.227
<b>6.87 pH</b>	6.984	6.951	6.923	6.900	6.881	6.865	6.853	6.844	6.840	6.838	6.834	6.833	6.834	6.836	6.845	6.859	6.877	6.886
<b>9.18 pH</b>	9.464	9.395	9.332	9.276	9.225	9.180	9.139	9.102	9.081	9.068	9.038	9.011	8.985	8.962	8.921	8.885	8.850	8.833

**Table 2 DIN 19267 (German buffers) so called: technical buffer solutions**

	0°C	10°C	20°C	25°C	30°C	40°C	50°C	60°C	70°C	80°C	90°C
<b>4.65 pH DIN</b>	4.670	4.660	4.650	4.650	4.650	4.660	4.680	4.700	4.720	4.750	4.790
<b>6.79 pH DIN</b>	6.890	6.840	6.800	6.790	6.780	6.760	6.760	6.760	6.760	6.780	6.800
<b>9.23 pH DIN</b>	9.480	9.370	9.270	9.230	9.180	9.090	9.000	8.920	8.880	8.850	8.820

**Table 3 US technical buffers**

	0°C	5°C	10°C	15°C	20°C	25°C	30°C	35°C	40°C	45°C	50°C	55°C	60°C
<b>4.0 pH US</b>	4.000	3.998	3.997	3.998	4.001	4.005	4.001	4.018	4.027	4.038	4.050	4.064	4.080
<b>7.0 pH US</b>	7.120	7.090	7.060	7.040	7.020	7.000	6.990	6.980	6.988	6.978	6.970	6.890	6.980
<b>10.0 pH US</b>	10.317	10.245	10.179	10.118	10.062	10.012	9.966	9.926	9.889	9.856	9.828	9.828	9.828

**Table 4 FREE PROGRAMMABLE (Default settings based on rounded NIST values).**

	0°C	5°C	10°C	15°C	20°C	25°C	30°C	35°C	40°C	45°C	50°C	55°C	60°C	65°C	70°C	75°C	80°C
<b>buffer 4</b>	4.00	4.00	4.00	4.00	4.00	4.01	4.02	4.02	4.04	4.05	4.06	4.08	4.09	4.11	4.13	4.15	4.16
<b>buffer 7</b>	6.98	6.95	6.92	6.90	6.88	6.87	6.85	6.84	6.84	6.83	6.83	6.83	6.84	6.84	6.85	6.85	6.86
<b>buffer 9</b>	9.46	9.40	9.33	9.28	9.23	9.18	9.14	9.10	9.07	9.04	9.01	8.99	8.96	8.94	8.92	8.90	8.89

The freely programmable table is populated with a basic set of data to provide a start for the user configuration. This table is intended for the user to be able to choose his buffer solutions to suit his own preference. The data concerning the pH temperature characteristic will need to be obtained from the supplier of the buffers.

### NOTE

Yokogawa recommend the use of NIST (primary buffer standards) rather than buffers which have been adjusted by the addition of acid or alkaline materials to the buffer composition. In this way the customer gets a recognized standard, as well as the best buffer capacity (the ability to resist pH change with contamination).

App.

PH

SENCOM



## Matrix temperature compensation

Table 5 shows the defaults for the matrix temperature compensation selectable in Temperature compensation (Section 4.2.3).

**Table 5 Defaults for the matrix temperature compensation (Reference temperature (Tref.): 25.0°C)**

	Temp. range	Solution 1 (Min.)	Solution 2	Solution 3	Solution 4	Solution 5 (Max.)
<b>Tref.</b>	(25.0°C)	6.40 pH	7.00 pH	7.30 pH	7.60 pH	9.00 pH
<b>Tmin. (T1)</b>	5.0°C	6.42 pH	7.38 pH	7.94 pH	8.31 pH	9.74 pH
<b>T2</b>	25.0°C	6.40 pH	7.00 pH	7.30 pH	7.60 pH	9.00 pH
<b>T3</b>	45.0°C	6.34 pH	6.70 pH	6.86 pH	7.06 pH	8.40 pH
<b>T4</b>	65.0°C	6.23 pH	6.45 pH	6.54 pH	6.67 pH	7.91 pH
<b>Tmax. (T5)</b>	85.0°C	6.11 pH	6.25 pH	6.31 pH	6.40 pH	7.51 pH

## User setting

Delete the matrix and then enter new values as shown in Table 6. Gray areas are mandatory. Other areas can be omitted.

**Table 6 Example of user setting (Reference temperature (Tref.): 25.0°C)**

	Temp. range	Solution 1 (Min.)	Solution 2	Solution 3	Solution 4	Solution 5 (Max.)
<b>Tref.</b>	(25.0°C)	6.40 pH	7.00 pH	7.30 pH	7.60 pH	9.00 pH
<b>Tmin. (T1)</b>	5.0°C	6.42 pH	7.38 pH	7.94 pH	8.31 pH	9.74 pH
<b>T2</b>	25.0°C	6.40 pH	7.00 pH	7.30 pH	7.60 pH	9.00 pH
<b>T3</b>	45.0°C	6.34 pH	6.70 pH	6.86 pH	7.06 pH	8.40 pH
<b>T4</b>	65.0°C	6.23 pH	6.45 pH	6.54 pH	6.67 pH	7.91 pH
<b>Tmax. (T5)</b>	85.0°C	6.11 pH	6.25 pH	6.31 pH	6.40 pH	7.51 pH

Note: The gray areas must be entered.

The reference temperature is set in the Temperature Compensation menu (default: 25.0°C).

Input temperatures for compensation in the Temp. ranges menu.

Input values from Solution 1 (low pH) to Solution 5 (high pH).

After entering all values, select “Check values?” to verify that there is no error. This function checks if the matrix is consistently incremental or decremental. If any error is found, its location is specified.

When there is no error, the matrix is compensated linearly and the blanks of the table (if any) are filled. If some areas are left empty without running “Check values?”, a 1st/2nd comp. matrix error will be issued.

## Changing the settings

If any setting is accidentally changed, values to the right of the relevant arrow in Table 7 are all initialized.

**Table 7 Parameters that initialize other values**

Sensor type ->	Measurement ->	Output: Process parameter ->	Linear: 0% value, 100% value
			Table
			Communication: HART: PV
			Display setup: Individual display (Main display)
		Trend Graph Screen ->	Y-axis (low, high)
			Communication: HART
			Impedance settings

## ■ Checking ORP sensor electrodes

The normal functionality of the ORP sensor electrode is determined by measuring the ORP value of the solution with a known ORP value, and by checking if the value is within the tolerable range.

To check the ORP sensor before regular operation, follow the procedure below.

The electrode is checked in measurement mode.

### ● Solution for checking

Use solutions with a known ORP value, such as quinhydrone, ferrous, and other solutions.

### ● Checking procedure

- (1) Pour 50 to 100 ml of the solution into a clean 200-ml beaker.
- (2) Remove the ORP sensor from the holder. Flush the measurement solution remaining on the sensor with water and wipe off the water. If the detecting part and liquid outlet of the sensor are stained, clean them with water.
- (3) Immerse the tip of the ORP sensor into the solution. Read the ORP value after the reading becomes stable (usually 5 to 10 minutes).

Measure the solution temperature and check if the ORP value at the temperature is in the tolerable range.

### ● Yokogawa's checking solution and tolerable range

Yokogawa offers the following reagents for checking. Use them as described below.

Quinhydrone (part number: K9024EC)

Ferrous (part number: K9024ED)

#### Quinhydrone solution

Put one bag of the reagent into a wide-mouthed jar (at least 250 ml) and pour deionized water into the jar to make a total solution volume of 250 ml. Cold deionized water may not dissolve the reagent completely and the reagent may partly float on the surface, but this does not cause any problem for measurement.

#### Ferrous solution

Put one bag of the reagent into a wide-mouthed jar (at least 250 mL) and pour 2 mol/l solution of sulfuric acid to make a total solution volume of 250 ml.

When using concentrated sulfuric acid, first pour approximately 150 ml of pure water into a wide-mouthed jar that contains the reagent. Add 14 ml of concentrated sulfuric acid while stirring the solution. Add more pure water to further dissolve the reagent and make a total solution volume of 250 ml.

## CAUTION

Be careful to touch the concentrated sulfuric acid.

Figure 1 shows the ORP values of the checking solutions prepared with Yokogawa's reagents. If the measured ORP value is in the tolerable range, the electrode of the ORP sensor is working normally.

If the ORP value is out of the range, calibrate the sensor. If the ORP value is slightly out of range, verify whether the checking solution has been properly prepared.

App.

PH

SENCOM

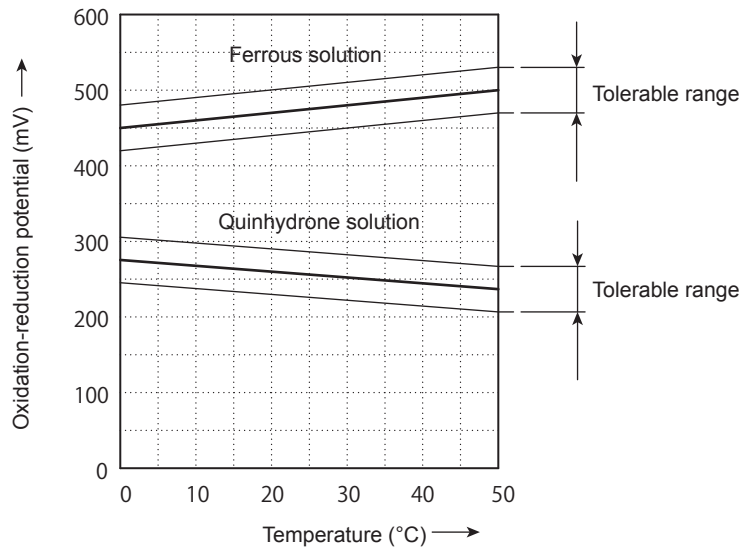

Figure 1 Oxidation-Reduction Potential given by Checking Solution (Reference electrode: 3.3 mol KCl - AgCl)

# Appendix 2 For SC (Conductivity)

## ■ Temperature compensation

The conductivity of a solution is very dependent on temperature. Typically for every 1°C change in temperature the solution conductivity will change by approximately 2%. The effect of temperature varies from one solution to another and is determined by several factors like solution composition, concentration and temperature range. A coefficient ( $\alpha$ ) is introduced to express the amount of temperature influence in % change in conductivity/°C. In almost all applications this temperature influence must be compensated before the conductivity reading can be interpreted as an accurate measure of concentration or purity.

### ● NaCl (standard temperature compensation)

The FLXA202/FLXA21 has the default temperature compensation function based on a sodium chloride (NaCl) solution. This function can be used for various applications and is compatible with the NaCl compensation function of typical laboratory or portable instruments.

**Table 1 NaCl compensation according to IEC 60746-3 with Tref. = 25°C**

Temperature (°C)	Ratio*	Temperature compensation coefficient (%/°C)	Temperature (°C)	Ratio*	Temperature compensation coefficient (%/°C)
0	0.54	1.8	100	2.68	2.2
10	0.72	1.9	110	2.90	2.2
20	0.90	2.0	120	3.12	2.2
25	1.00	—	130	3.34	2.2
30	1.10	2.0	140	3.56	2.2
40	1.31	2.0	150	3.79	2.2
50	1.53	2.1	160	4.03	2.2
60	1.76	2.2	170	4.23	2.2
70	1.99	2.2	180	4.42	2.2
80	2.22	2.2	190	4.61	2.2
90	2.45	2.2	200	4.78	2.2

\*: The ratio of the conductivity at respective temperatures to the conductivity at the reference temperature.

### ● Temperature compensation coefficient (TC)

Set the temperature compensation coefficient based on the degree of influence of temperature on the conductivity (%/°C).

If the temperature compensation coefficient of the sample solution is known from laboratory experiments or has been previously determined, enter the value.

The setting range is between 0.00 and 10.0%. By combining with the reference temperature setting, a linear compensation function can be obtained. This is applicable to all kinds of chemical solution.

#### <Configure calculated temperature coefficient (TC).>

Follow routing

Commissioning >> Measurement setup >> Temp.compensation >> T.C.

Enter the temperature coefficient calculated from the following formula:

App.

SC

**A. Calculation of temperature coefficient factor (With known conductivity at reference temperature).**

$$\alpha = \frac{K_t - K_{ref}}{T - T_{ref}} \times \frac{100}{K_{ref}}$$

$\alpha$  = Temperature compensation factor in %/°C

T = Measured temperature in °C

$K_t$  = Conductivity at T

$T_{ref}$  = Reference temperature

$K_{ref}$  = Conductivity at  $T_{ref}$

**B. Calculation of temperature coefficient factor (with two known conductivity values at different temperatures)**

Measure the conductivity of the liquid at two temperatures, one below the reference and above the reference temperature with the temperature coefficient set to 0,00%/°C and use the following equation to calculate a temperature coefficient ( $\alpha$ ).

$$K_{ref} = \frac{K_T}{1 + \alpha (T - T_{ref})}$$

$$K_{ref} = \frac{K_1}{1 + \alpha (T_1 - T_{ref})} = \frac{K_2}{1 + \alpha (T_2 - T_{ref})}$$

$$K_1(1 + \alpha (T_2 - T_{ref})) = K_2(1 + \alpha (T_1 - T_{ref}))$$

$$K_1 \cdot \alpha (T_2 - T_{ref}) - K_2 \cdot \alpha (T_1 - T_{ref}) = K_2 - K_1$$

$$\alpha = \frac{K_2 - K_1}{K_1(T_2 - T_{ref}) - K_2(T_1 - T_{ref})}$$

Where  $T_1, T_2$ : liquid temperature (°C)

$K_1$ : conductivity at  $T_1$  (°C)

$K_2$ : conductivity at  $T_2$  (°C)

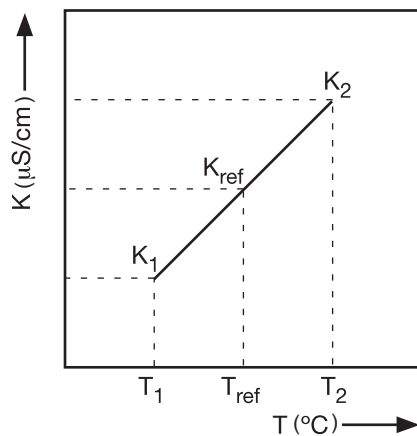

**Figure 1** Conductivity

## &lt;Calculation example&gt;

Calculate the temperature coefficient of a liquid from the following data.

Conductivity 124.5  $\mu\text{S}/\text{cm}$  at a liquid temperature of 18.0 °C and a conductivity 147.6  $\mu\text{S}/\text{cm}$  at a liquid temperature of 31.0 °C.

Substituting the data in the above formula gives the following result.

$$\alpha = \frac{147.6 - 124.5}{124.5 \times (31.0 - 25) - 147.6 \times (18.0 - 25)} \times 100 = 1.298 \% / ^\circ\text{C}$$

Set the temperature coefficient in the FLXA202/FLXA21 converter.

When the temperature coefficient already set is accurate, the conductivity to be displayed must be constant regardless of liquid temperature. The following check will make sure that the temperature coefficient already set is accurate.

If, when the liquid temperature is lowered, a larger conductivity value is indicated, the temperature coefficient already set is too small.

The opposite also applies. If a smaller conductivity value is indicated, the temperature coefficient already set is too large. In either case, change the temperature coefficient so that the conductivity no longer changes.

## ● Matrix

Matrix means temperature compensation with the temperature compensation matrix.

The temperature compensation matrix is a table of conductivity values at different temperatures and concentrations.

Ready-made matrixes and user-defined matrixes are available.

### <Ready-made matrixes>

Ready-made temperature compensation matrixes are available for common inorganic acids and bases. Those for ammonia and morpholine are also available.

**Table 2 Ready-made temperature compensation matrixes**

Select matrix	Compound to be measured	Concentration	Temperature	Details
Ammonia 0..50ppb	Ammonia	0 to 50 ppb	0 to 90 °C	Table A
Morpholine 0..500ppb	Morpholine	0 to 500 ppb	0 to 90 °C	Table B
Ammonia 15..30%	Ammonia	15 to 30%	10 to 50 °C	Table C
Sulfuric acid 0..27%	H <sub>2</sub> SO <sub>4</sub>	0 to 27%	-1.1 to 98.9 °C	Table D
Sulfuric acid 39..85%	H <sub>2</sub> SO <sub>4</sub>	39 to 85%	-17.8 to 115.6 °C	Table E
Sulfuric acid 93..100%	H <sub>2</sub> SO <sub>4</sub>	93 to 100%	10 to 90 °C	Table F
NaOH 0..15%	NaOH	0 to 15%	0 to 100 °C	Table G
NaOH 25..50%	NaOH	25 to 50%	0 to 80 °C	Table H
HCl 0..200ppb	HCl	0 to 200 ppb	0 to 100 °C	Table I
HCl 0..18%	HCl	0 to 18.2%	-10 to 65 °C	Table J
HCl 24..44%	HCl	23.7 to 43.8%	-20 to 65 °C	Table K
HNO <sub>3</sub> 0..25%	HNO <sub>3</sub>	0 to 24.80%	0 to 80 °C	Table L
HNO <sub>3</sub> 35..88%	HNO <sub>3</sub>	35.0 to 87.7%	-16 to 60 °C	Table M

The ready-made temperature compensation matrixes are listed in Table A to M where temperatures are in the column and concentrations are in the rows.

Table A Ammonia 0..50ppb (Conductivity unit: µS/cm)

Solutions (Conc.) Temp.ranges		Solut. Min.	Solu- tion 2	Solu- tion 3	Solu- tion 4	Solu- tion 5	Solu- tion 6	Solu- tion 7	Solu- tion 8	Solu- tion 9	Solut. Max.
		0 ppb	1 ppb	2 ppb	3 ppb	5 ppb	7 ppb	10 ppb	20 ppb	30 ppb	50 ppb
Tmin.	0 °C	0.0116	0.0173	0.0229	0.0320	0.0502	0.0688	0.0966	0.178	0.259	0.423
2.	10 °C	0.0230	0.0284	0.0337	0.0442	0.0651	0.0879	0.122	0.225	0.328	0.535
3.	20 °C	0.0419	0.0466	0.0512	0.0622	0.0842	0.111	0.150	0.274	0.398	0.648
4.	30 °C	0.0710	0.0749	0.0788	0.0895	0.111	0.139	0.181	0.325	0.469	0.758
5.	40 °C	0.114	0.117	0.120	0.130	0.149	0.178	0.221	0.382	0.543	0.866
6.	50 °C	0.173	0.176	0.178	0.186	0.203	0.231	0.273	0.448	0.623	0.974
7.	60 °C	0.251	0.254	0.256	0.263	0.278	0.304	0.344	0.531	0.718	1.09
8.	70 °C	0.350	0.353	0.356	0.363	0.377	0.402	0.439	0.637	0.835	1.23
9.	80 °C	0.471	0.475	0.479	0.486	0.501	0.526	0.563	0.770	0.977	1.39
Tmax.	90 °C	0.611	0.617	0.623	0.631	0.647	0.671	0.707	0.923	1.14	1.57
Tref.	25.0 °C	0.0565	0.0608	0.0650	0.0759	0.0976	0.125	0.166	0.300	0.434	0.703

Table B Morpholine 0..500ppb (Conductivity unit: µS/cm)

Solutions (Conc.) Temp.ranges		Solut. Min.	Solu- tion 2	Solu- tion 3	Solu- tion 4	Solu- tion 5	Solu- tion 6	Solu- tion 7	Solu- tion 8	Solu- tion 9	Solut. Max.
		0 ppb	10 ppb	20 ppb	30 ppb	50 ppb	70 ppb	100 ppb	200 ppb	300 ppb	500 ppb
Tmin.	0 °C	0.0116	0.0252	0.0272	0.0370	0.0565	0.0724	0.0963	0.144	0.192	0.288
2.	10 °C	0.0230	0.0316	0.0402	0.0537	0.0807	0.104	0.139	0.212	0.285	0.431
3.	20 °C	0.0419	0.0502	0.0585	0.0749	0.108	0.139	0.185	0.287	0.389	0.592
4.	30 °C	0.0710	0.0781	0.0851	0.103	0.140	0.178	0.235	0.367	0.499	0.763
5.	40 °C	0.113	0.119	0.124	0.143	0.181	0.224	0.289	0.452	0.614	0.938
6.	50 °C	0.173	0.177	0.181	0.199	0.234	0.281	0.351	0.544	0.736	1.12
7.	60 °C	0.251	0.254	0.257	0.273	0.306	0.354	0.427	0.648	0.869	1.31
8.	70 °C	0.350	0.354	0.357	0.372	0.403	0.452	0.526	0.773	1.02	1.52
9.	80 °C	0.471	0.476	0.481	0.497	0.528	0.578	0.654	0.932	1.22	1.77
Tmax.	90 °C	0.611	0.619	0.626	0.642	0.674	0.724	0.798	1.10	1.41	2.03
Tref.	25.0 °C	0.0565	0.0642	0.0718	0.0890	0.124	0.159	0.210	0.327	0.444	0.678

Table C Ammonia 15..30% (Conductivity unit: mS/cm)

Solutions (Conc.) Temp.ranges		Solut. Min.	Solu- tion 2	Solu- tion 3	Solu- tion 4	Solu- tion 5	Solu- tion 6	Solu- tion 7	Solu- tion 8	Solu- tion 9	Solut. Max.
		15 %	16 %	18 %	19 %	20 %	22 %	24 %	26 %	28 %	30 %
Tmin.	10 °C	0.480	0.430	0.355	0.320	0.295	0.250	0.215	0.185	0.155	0.130
2.	15 °C	0.580	0.530	0.440	0.400	0.370	0.315	0.265	0.235	0.205	0.170
3.	18 °C	0.649	0.600	0.506	0.466	0.433	0.372	0.316	0.277	0.238	0.190
4.	20 °C	0.695	0.645	0.550	0.510	0.475	0.410	0.350	0.305	0.260	0.215
5.	25 °C	0.820	0.770	0.650	0.610	0.560	0.490	0.420	0.360	0.310	0.254
6.	30 °C	0.930	0.870	0.755	0.700	0.650	0.560	0.485	0.420	0.355	0.292
7.	35 °C	1.04	0.970	0.843	0.780	0.733	0.638	0.553	0.477	0.403	0.331
8.	40 °C	1.14	1.07	0.930	0.860	0.815	0.715	0.620	0.533	0.450	0.370
9.	45 °C	1.25	1.16	1.02	0.945	0.890	0.783	0.675	0.581	0.490	0.402
Tmax.	50 °C	1.35	1.26	1.10	1.03	0.965	0.850	0.730	0.628	0.530	0.433
Tref.	25.0 °C	0.820	0.770	0.650	0.610	0.560	0.490	0.420	0.360	0.310	0.254

Table D Sulfonic acid 0..27% (Conductivity unit: S/cm)

Solutions (Conc.)		Solut. Min.	Solu-tion 2	Solu-tion 3	Solu-tion 4	Solu-tion 5	Solu-tion 6	Solu-tion 7	Solu-tion 8	Solu-tion 9	Solut. Max.
Temp.ranges		0 %	5 %	8 %	12 %	14 %	17 %	20 %	22 %	24 %	27 %
Tmin.	-1.1 °C	0	0.1496	0.2330	0.3275	0.3695	0.4225	0.4640	0.4850	0.5005	0.5140
2.	10.0 °C	0	0.1813	0.3845	0.4030	0.4355	0.5210	0.5725	0.5980	0.6160	0.6340
3.	21.1 °C	0	0.2102	0.3330	0.4740	0.5335	0.6145	0.6805	0.7140	0.7385	0.7625
4.	32.2 °C	0	0.2351	0.3740	0.5360	0.6070	0.7030	0.7810	0.8225	0.8540	0.8860
5.	43.3 °C	0	0.2574	0.4130	0.5945	0.6735	0.7835	0.8755	0.9250	0.9635	1.0050
6.	54.4 °C	0	0.2674	0.4450	0.6455	0.7315	0.8533	0.9600	1.0190	1.0660	1.1180
7.	60.0 °C	0	0.2853	0.4600	0.6670	0.7570	0.8860	0.9980	1.0600	1.1110	1.1700
8.	71.1 °C	0	0.3007	0.4860	0.7070	0.8060	0.9470	1.0710	1.1400	1.1970	1.2640
9.	87.8 °C	0	0.3217	0.5210	0.7605	0.8665	1.0250	1.1630	1.2420	1.3100	1.3940
Tmax.	98.9 °C	0	0.3335	0.5420	0.7885	0.9025	1.0650	1.2160	1.3020	1.3760	1.4690
Tref.	25.0 °C	0	0.2190	0.3470	0.4960	0.5590	0.6450	0.7160	0.7520	0.7790	0.8060

Table E Sulfonic acid 39..85% (Conductivity unit: S/cm)

Solutions (Conc.)		Solut. Min.	Solu-tion 2	Solu-tion 3	Solu-tion 4	Solu-tion 5	Solu-tion 6	Solu-tion 7	Solu-tion 8	Solu-tion 9	Solut. Max.
Temp.ranges		39 %	44 %	50 %	55 %	60 %	65 %	70 %	75 %	80 %	85 %
Tmin.	-17.8 °C	0.2775	0.2500	0.2125	0.1770	0.1385	0.1020	0.0710	0.0435	0.0140	0
2.	4.4 °C	0.5225	0.4695	0.4000	0.3265	0.2750	0.2105	0.1500	0.0990	0.0655	0.0610
3.	21.1 °C	0.7220	0.6590	0.5700	0.4670	0.3950	0.3085	0.2315	0.1650	0.1200	0.1100
4.	32.2 °C	0.8600	0.7895	0.6870	0.5715	0.4870	0.3850	0.2950	0.2190	0.1655	0.1530
5.	43.3 °C	0.9225	0.9190	0.8080	0.6770	0.5830	0.4670	0.3640	0.2785	0.2190	0.2040
6.	54.4 °C	1.1250	1.0510	0.9305	0.7825	0.6770	0.5505	0.4400	0.3475	0.2825	0.2620
7.	65.6 °C	1.2490	1.1760	1.0530	0.8950	0.7810	0.6430	0.5220	0.4210	0.3495	0.3255
8.	82.2 °C	1.4340	1.3670	1.2370	1.0640	0.9390	0.7900	0.6570	0.5430	0.4620	0.4315
9.	98.9 °C	1.5950	1.5400	1.4150	1.2350	1.1000	0.9370	0.7960	0.6750	0.5880	0.5450
Tmax.	115.6 °C	1.7350	1.6920	1.5660	1.4250	1.2600	1.0910	0.9345	0.8110	0.7190	0.6630
Tref.	25.0 °C	0.7700	0.7050	0.6110	0.5040	0.4270	0.3350	0.2530	0.1840	0.1360	0.1250

Table F Sulfonic acid 93..100% (Conductivity unit: S/cm)

Solutions (Conc.)		Solut. Min.	Solu-tion 2	Solu-tion 3	Solu-tion 4	Solu-tion 5	Solu-tion 6	Solu-tion 7	Solu-tion 8	Solu-tion 9	Solut. Max.
Temp.ranges		93.0 %	94.0 %	95.0 %	95.5 %	96.0 %	97.0 %	97.5 %	98.0 %	99.0 %	100.0 %
Tmin.	10 °C	0.0860	0.0835	0.0800	0.0768	0.0735	0.0640	0.0563	0.0485	0.0225	0
2.	20 °C	0.1153	0.1143	0.1110	0.1086	0.1051	0.0961	0.0895	0.0812	0.0580	0.0085
3.	25 °C	0.1320	0.1310	0.1260	0.1230	0.1190	0.1090	0.1020	0.0920	0.0640	0.0105
4.	30 °C	0.1490	0.1467	0.1414	0.1375	0.1332	0.1220	0.1138	0.1035	0.0703	0.0125
5.	40 °C	0.1897	0.1860	0.1787	0.1739	0.1680	0.1520	0.1410	0.1295	0.0869	0.0171
6.	50 °C	0.2323	0.2275	0.2190	0.2124	0.2041	0.1833	0.1710	0.1574	0.1067	0.0219
7.	60 °C	0.2787	0.2715	0.2604	0.2530	0.2440	0.2200	0.2053	0.1884	0.1275	0.0279
8.	70 °C	0.3284	0.3196	0.3065	0.2970	0.2853	0.2594	0.2420	0.2255	0.1495	0.0240
9.	80 °C	0.3826	0.3714	0.3550	0.3450	0.3332	0.3015	0.2813	0.2570	0.1732	0.0404
Tmax.	90 °C	0.4390	0.4250	0.4050	0.3923	0.3775	0.3405	0.3175	0.2910	0.1975	0.0460
Tref.	25.0 °C	0.1320	0.1310	0.1260	0.1230	0.1190	0.1090	0.1020	0.0920	0.0640	0.0105

App.

SC



Table G NaOH 0..15% (Conductivity unit: S/cm)

Solutions (Conc.) Temp.ranges		Solut. Min.	Solu- tion 2	Solu- tion 3	Solu- tion 4	Solu- tion 5	Solu- tion 6	Solu- tion 7	Solu- tion 8	Solu- tion 9	Solut. Max.
		0 %	1 %	3 %	4 %	5 %	6 %	8 %	10 %	12 %	15 %
Tmin.	0 °C	0	0.035	0.087	0.113	0.133	0.150	0.176	0.195	0.206	0.215
2.	10 °C	0	0.042	0.109	0.140	0.167	0.190	0.226	0.255	0.274	0.293
3.	18 °C	0	0.047	0.125	0.163	0.195	0.221	0.267	0.303	0.327	0.345
4.	25 °C	0	0.052	0.142	0.183	0.222	0.256	0.313	0.355	0.381	0.410
5.	30 °C	0	0.056	0.153	0.200	0.242	0.278	0.338	0.389	0.424	0.467
6.	40 °C	0	0.063	0.179	0.233	0.281	0.323	0.396	0.458	0.502	0.551
7.	50 °C	0	0.070	0.201	0.265	0.320	0.368	0.454	0.527	0.580	0.645
8.	60 °C	0	0.080	0.223	0.293	0.355	0.410	0.507	0.592	0.658	0.742
9.	80 °C	0	0.100	0.270	0.350	0.425	0.493	0.612	0.721	0.814	0.936
Tmax.	100 °C	0	0.119	0.315	0.407	0.495	0.574	0.717	0.850	0.967	1.130
Tref.	25.0 °C	0	0.052	0.142	0.183	0.222	0.256	0.313	0.355	0.381	0.410

Table H NaOH 25..50% (Conductivity unit: S/cm)

Solutions (Conc.) Temp.ranges		Solut. Min.	Solu- tion 2	Solu- tion 3	Solu- tion 4	Solu- tion 5	Solu- tion 6	Solu- tion 7	Solu- tion 8	Solu- tion 9	Solut. Max.
		25 %	28 %	30 %	32 %	35 %	38 %	40 %	42 %	45 %	50 %
Tmin.	0 °C	0.140	0.100	0.075	0.060	0.040	0.024	0.017	0.012	0.010	0.007
2.	10 °C	0.212	0.174	0.148	0.124	0.094	0.074	0.063	0.053	0.038	0.025
3.	18 °C	0.270	0.232	0.207	0.184	0.153	0.131	0.120	0.105	0.090	0.078
4.	25 °C	0.352	0.313	0.289	0.266	0.233	0.207	0.194	0.180	0.162	0.146
5.	30 °C	0.411	0.372	0.347	0.323	0.291	0.264	0.248	0.233	0.214	0.195
6.	40 °C	0.528	0.489	0.463	0.440	0.405	0.373	0.354	0.337	0.317	0.293
7.	50 °C	0.645	0.605	0.580	0.556	0.520	0.482	0.460	0.441	0.420	0.390
8.	60 °C	0.796	0.766	0.746	0.724	0.694	0.660	0.639	0.623	0.604	0.570
9.	75 °C	1.023	1.007	0.995	0.980	0.955	0.925	0.908	0.893	0.873	0.839
Tmax.	80 °C	1.098	1.086	1.078	1.066	1.042	1.015	0.997	0.982	0.963	0.929
Tref.	25.0 °C	0.352	0.313	0.289	0.266	0.233	0.207	0.194	0.180	0.162	0.146

Table I HCl 0..200ppb (Conductivity unit: µS/cm)

Solutions (Conc.) Temp.ranges		Solut. Min.	Solu- tion 2	Solu- tion 3	Solu- tion 4	Solu- tion 5	Solu- tion 6	Solu- tion 7	Solu- tion 8	Solu- tion 9	Solut. Max.
		0 ppb	1 ppb	2 ppb	4 ppb	10 ppb	20 ppb	50 ppb	100 ppb	150 ppb	200 ppb
Tmin.	0 °C	0.0116	0.0135	0.0161	0.0228	0.0472	0.0912	0.2256	0.4504	0.6755	0.9005
2.	10 °C	0.0230	0.0253	0.0281	0.0352	0.0630	0.1163	0.2834	0.5645	0.8462	1.1280
3.	20 °C	0.0420	0.0446	0.0476	0.0550	0.0843	0.1443	0.3407	0.6755	1.0115	1.3479
4.	30 °C	0.0713	0.0743	0.0776	0.0852	0.1149	0.1785	0.3993	0.7837	1.1714	1.5599
5.	40 °C	0.1144	0.1177	0.1212	0.1291	0.1588	0.2234	0.4617	0.8904	1.3261	1.7636
6.	50 °C	0.1746	0.1781	0.1819	0.1901	0.2198	0.2838	0.5316	0.9969	1.4758	1.9584
7.	60 °C	0.2549	0.2586	0.2626	0.2711	0.3009	0.3637	0.6139	1.1058	1.6213	2.1439
8.	70 °C	0.3577	0.3617	0.3658	0.3745	0.4044	0.4657	0.7127	1.2198	1.7638	2.3198
9.	80 °C	0.4842	0.4883	0.4926	0.5015	0.5313	0.5910	0.8312	1.3419	1.9045	2.4858
Tmax.	100 °C	0.8052	0.8094	0.8137	0.8225	0.8515	0.9075	1.1273	1.6153	2.1819	2.7844
Tref.	25.0 °C	0.0551	0.0579	0.0611	0.0686	0.0982	0.1604	0.3697	0.7299	1.0921	1.4549

Table J HCl 0..18% (Conductivity unit: S/cm)

Solutions (Conc.)		Solut. Min.	Solu-tion 2	Solu-tion 3	Solu-tion 4	Solu-tion 5	Solu-tion 6	Solu-tion 7	Solu-tion 8	Solu-tion 9	Solut. Max.
Temp.ranges		0 %	3.65 %	5.48 %	7.30 %	9.12 %	11.0 %	12.8 %	14.6 %	16.4 %	18.2 %
Tmin.	-10 °C	0	0.174	0.226	0.277	0.329	0.362	0.390	0.409	0.427	0.439
2.	0 °C	0	0.212	0.294	0.364	0.421	0.464	0.489	0.514	0.538	0.552
3.	10 °C	0	0.262	0.362	0.445	0.512	0.566	0.603	0.629	0.654	0.668
4.	15 °C	0	0.284	0.395	0.481	0.554	0.610	0.653	0.681	0.708	0.722
5.	20 °C	0	0.312	0.431	0.526	0.600	0.658	0.706	0.737	0.768	0.783
6.	25 °C	0	0.332	0.459	0.563	0.647	0.713	0.764	0.794	0.824	0.837
7.	30 °C	0	0.359	0.497	0.607	0.692	0.760	0.815	0.850	0.885	0.901
8.	45 °C	0	0.425	0.587	0.721	0.830	0.914	0.978	1.02	1.06	1.08
9.	55 °C	0	0.468	0.648	0.796	0.917	1.01	1.08	1.13	1.17	1.17
Tmax.	65 °C	0	0.509	0.705	0.867	1.00	1.10	1.18	1.23	1.28	1.31
Tref.	25.0 °C	0	0.332	0.459	0.563	0.647	0.713	0.764	0.794	0.824	0.837

Table K HCl 24..44% (Conductivity unit: S/cm)

Solutions (Conc.)		Solut. Min.	Solu-tion 2	Solu-tion 3	Solu-tion 4	Solu-tion 5	Solu-tion 6	Solu-tion 7	Solu-tion 8	Solu-tion 9	Solut. Max.
Temp.ranges		23.7 %	25.6 %	29.2 %	31.0 %	32.8 %	34.7 %	36.5 %	38.3 %	40.1 %	43.8 %
Tmin.	-20 °C	0.354	0.351	0.342	0.335	0.328	0.319	0.312	0.303	0.295	0.277
2.	0 °C	0.560	0.555	0.538	0.524	0.511	0.497	0.482	0.467	0.452	0.424
3.	10 °C	0.670	0.661	0.635	0.620	0.604	0.587	0.570	0.553	0.537	0.504
4.	15 °C	0.722	0.712	0.685	0.669	0.652	0.635	0.616	0.597	0.579	0.540
5.	20 °C	0.783	0.771	0.739	0.720	0.700	0.679	0.658	0.637	0.617	0.576
6.	25 °C	0.830	0.818	0.786	0.768	0.748	0.728	0.707	0.686	0.662	0.622
7.	30 °C	0.898	0.885	0.849	0.827	0.805	0.782	0.759	0.736	0.714	0.667
8.	45 °C	1.07	1.06	1.01	0.989	0.964	0.938	0.911	0.883	0.855	0.797
9.	55 °C	1.19	1.17	1.12	1.09	1.06	1.03	1.00	0.970	0.940	0.910
Tmax.	65 °C	1.30	1.28	1.23	1.20	1.17	1.14	1.11	1.08	1.05	1.02
Tref.	25.0 °C	0.830	0.818	0.786	0.768	0.748	0.728	0.707	0.686	0.662	0.622

Table L HNO<sub>3</sub> 0..25% (Conductivity unit: S/cm)

Solutions (Conc.)		Solut. Min.	Solu-tion 2	Solu-tion 3	Solu-tion 4	Solu-tion 5	Solu-tion 6	Solu-tion 7	Solu-tion 8	Solu-tion 9	Solut. Max.
Temp.ranges		0 %	3.12 %	6.20 %	9.30 %	12.40 %	15.32 %	17.72 %	20.11 %	22.46 %	24.80 %
Tmin.	0 °C	0	0.1140	0.2259	0.3120	0.3980	0.4472	0.4854	0.5236	0.5498	0.5760
2.	18 °C	0	0.1606	0.3178	0.4345	0.5512	0.6062	0.6559	0.7055	0.7368	0.7680
3.	20 °C	0	0.1650	0.3215	0.4395	0.5575	0.6236	0.6742	0.7248	0.7568	0.7888
4.	25 °C	0	0.1780	0.3490	0.4760	0.6030	0.6655	0.7186	0.7717	0.8119	0.8520
5.	30 °C	0	0.1900	0.3665	0.5002	0.6339	0.7065	0.7619	0.8172	0.8555	0.8938
6.	40 °C	0	0.2110	0.4095	0.5588	0.7081	0.7860	0.8451	0.9042	0.9511	0.9980
7.	50 °C	0	0.2600	0.4507	0.6154	0.7801	0.8620	0.9239	0.9857	1.044	1.102
8.	60 °C	0	0.3100	0.4899	0.6699	0.8498	0.9345	0.9982	1.062	1.133	1.205
9.	70 °C	0	0.3330	0.5273	0.7223	0.9173	1.004	1.068	1.132	1.219	1.306
Tmax.	80 °C	0	0.3560	0.5660	0.7770	0.9826	1.069	1.133	1.198	1.302	1.407
Tref.	25.0 °C	0	0.1780	0.3490	0.4760	0.6030	0.6655	0.7186	0.7715	0.8119	0.8520

App.

SC

Table M HNO<sub>3</sub> 35..88% (Conductivity unit: S/cm)

Solutions (Conc.)		Solut. Min.	Solu- tion 2	Solu- tion 3	Solu- tion 4	Solu- tion 5	Solu- tion 6	Solu- tion 7	Solu- tion 8	Solu- tion 9	Solut. Max.
		35.0 %	37.2 %	43.3 %	49.6 %	55.8 %	62.0 %	75.0 %	76.6 %	82.0 %	87.7 %
Tmin.	-16 °C	0.412	0.400	0.368	0.334	0.288	0.254	0.163	0.147	0.089	0.044
2.	0 °C	0.576	0.555	0.507	0.456	0.404	0.352	0.227	0.208	0.128	0.060
3.	10 °C	0.678	0.666	0.614	0.555	0.493	0.438	0.268	0.246	0.153	0.069
4.	18 °C	0.770	0.754	0.700	0.634	0.565	0.506	0.300	0.277	0.172	0.077
5.	20 °C	0.786	0.776	0.721	0.654	0.583	0.512	0.310	0.290	0.175	0.079
6.	25 °C	0.842	0.831	0.784	0.714	0.636	0.559	0.340	0.315	0.185	0.081
7.	30 °C	0.895	0.886	0.827	0.754	0.672	0.590	0.370	0.335	0.190	0.083
8.	40 °C	1.001	0.995	0.938	0.858	0.774	0.690	0.430	0.375	0.200	0.087
9.	50 °C	1.105	1.095	1.038	0.958	0.874	0.790	0.485	0.415	0.210	0.091
Tmax.	60 °C	1.205	1.195	1.138	1.058	0.974	0.890	0.530	0.455	0.220	0.095
Tref.	25.0 °C	0.842	0.831	0.784	0.714	0.636	0.559	0.340	0.315	0.185	0.081

<User-defined matrixes>

The user-defined temperature compensation matrix is a matrix defined by users. Enter values as shown in Table 3. The gray areas must be entered.

Table 3 Example of user-defined matrix (Reference temperature (Tref.): 25.0 °C, Conductivity unit: S/cm)

Solutions (Conc.)		Solut. Min.	Solut. Max.	Solu- tion 2	Solu- tion 3	Solu- tion 4	Solu- tion 5	Solu- tion 6	Solu- tion 7	Solu- tion 8	Solu- tion 9
		0 %	15 %	1 %	3 %	4 %	5 %	6 %	8 %	10 %	12 %
Tref.	(25.0 °C)	0.013	0.410	0.052	0.142	0.183	0.222	0.256	0.313	0.355	0.381
Tmin.	0 °C	0.009	0.215	0.035	0.087	0.113	0.133	0.150	0.176	0.195	0.206
Tmax.	100 °C	0.025	1.13	0.119	0.315	0.407	0.495	0.574	0.717	0.850	0.967
2.	10 °C	0.010	0.293	0.042	0.109	0.140	0.167	0.190	0.226	0.255	0.274
3.	18 °C	0.012	0.357	0.047	0.125	0.163	0.195	0.221	0.267	0.303	0.327
4.	25 °C	0.013	0.410	0.052	0.142	0.183	0.222	0.256	0.313	0.355	0.381
5.	30 °C	0.014	0.468	0.056	0.153	0.200	0.242	0.278	0.338	0.389	0.424
6.	40 °C	0.015	0.551	0.067	0.179	0.233	0.281	0.323	0.396	0.458	0.502
7.	50 °C	0.017	0.645	0.070	0.201	0.265	0.320	0.368	0.454	0.527	0.580
8.	60 °C	0.018	0.742	0.080	0.223	0.293	0.355	0.410	0.507	0.592	0.658
9.	80 °C	0.021	0.936	0.100	0.270	0.350	0.425	0.493	0.612	0.721	0.814

Note: This table is as shown on the screen. The gray areas must be entered.

Set the reference temperature in the Temp. comp. screen (default: 25.0°C).

Input concentration values in the Solution screen.

The values must be entered in ascending order from Solution (Min.) to Solution (Max.). Solution (Min.) and Solution (Max.) must be entered.

Input temperatures for compensation in the Temp. ranges screen.

Input the conductivity values\* at respective temperatures in the Solution (Min.) screen and those in the Solution (Max.) screen. Input other values, if any, in the Solution n screen.

\*: Enter the precompensated conductivity.

All cells of two user-defined matrixes are blank as a default. If any cells are not blank, clear them.

After entering all values, select "Check values?" to verify that there is no error.

This function checks if the matrix is consistently incremental or decremental. If any error is found, its location is specified.

If there is no error, the matrix is compensated linearly and the blanks of the table (if any) are filled. If some areas are left empty without running "Check values?", a 1st/2nd comp. matrix error will be issued.

## ■ Temperature compensation error

The temperature compensation error (alarm) is issued in any of the following cases.

### ● TC

The error is issued when:

(measured temperature – reference temperature) < –90/compensation coefficient

The default of the temperature compensation coefficient is 2.10%/°C.

For example, when the reference temperature is 25°C, the temperature compensation coefficient is 2.10%/°C and the measured temperature is lower than –17.9°C, the error will be issued.

Temperature compensation is performed even while an alarm is being issued.

### ● Matrix

The error is issued when the temperature or the precompensated conductivity is out of the range of the temperature compensation matrix.

In this case, however, the temperature compensation is performed by extrapolation even while an alarm is being issued.

### ● All

When the conductivity is around zero, the temperature compensation error may be issued. In this case, the temperature compensation is not performed, and the precompensated conductivity is displayed.

Whether the conductivity is around zero or not is determined by the temperature and conductivity of solutions. For example, when the temperature is 20°C and the conductivity is lower than 0.033 µS/cm, the conductivity is determined to be around zero.

When measuring the conductivity around zero in air calibration or when the conductivity to be measured is around zero, an alarm may be issued.

## NOTE

To display the precompensated conductivity, set the Method to “None”.

Select Measurement setup → Temp. compensation.

## ■ TDS readings

The concept of Total Dissolved Solids (TDS) is widely used as an indication of the total solute concentration in water and is a widely accepted water quality standard. The determination is simply made by evaporation and weighing the residue. As the heat treatment converts the chemical properties of the solution, some solutes that contribute to the total conductivity will not be found in the residue. Also some combinations of solutes will become volatile at the drying temperature. The same applies for those solutes that do not contribute to the conductivity but do end up in the residue. When one (or a few) solute is dominant in the solution, these problems may be neglected and TDS will have a direct correlation with the conductivity.

Next is a graph that shows the correlation between the specific conductance and concentrations (by weight) for six salts. The factor by which the conductivity should be multiplied to come to a TDS reading ranges from 0.4 to 0.7 up to a conductivity of 500 µS/cm. At a conductance of approximately 3000 µS/cm the range would be from 0.5 and 1.0.

The FLXA202/FLXA21 measures conductivity. This value can be used to display TDS values on the main display. One should use the additional concentration table. The unit for the TDS reading can be set to ppm or ppb.

App.

SC

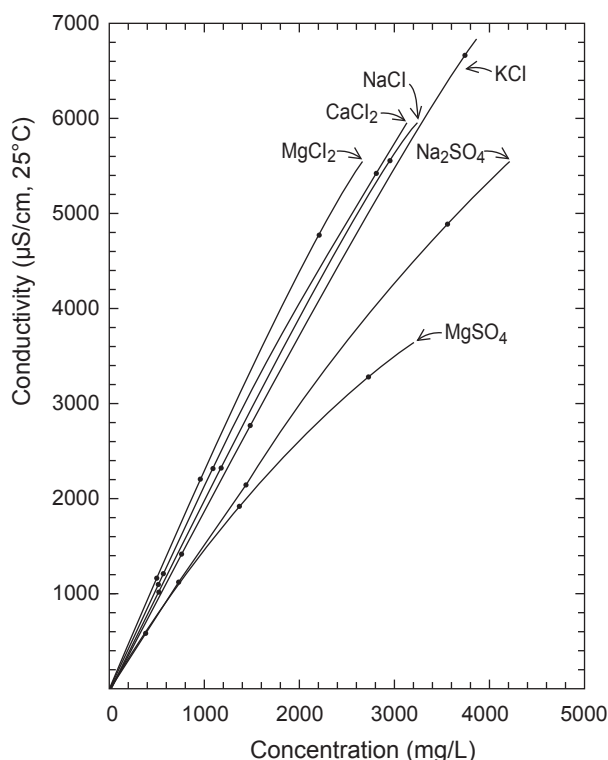

Figure 2 Relations of concentration and conductivity

## ■ Calibration solutions for conductivity

The calibration (cell constant) of a sensor does not change unless the sensor is damaged. It can also appear to change because of coating of the electrodes, or partial blockage. It does not make sense to regularly recalibrate the FLXA202/FLXA21.

A calibration check, however, is another matter. When the objective is clearly defined as a diagnostic exercise a regular check can bring an extra level of security and confidence to the measurement.

Sensor damage, and/or coatings can be difficult to see and the calibration check can confirm their presence, by a deviation from the known solution conductivity. The remedial action should be to clean the sensor, and carefully check for blockage or damage (not simply to recalibrate).

Higher conductivity solutions should be used where possible. The lower the conductivity of the test solution, the easier it is to contaminate. Carbon dioxide from the air can be quickly absorbed to cause an error. All containers must be suitably clean, and all materials suitably pure. Outside of a well-equipped laboratory these conditions are hard to meet.

Also note that the check must be performed with due regard to the cell constant of the sensor, as it limits the effective working range. The documentation provided with the sensor should be consulted to determine its maximum working value. By using a checking solution close to the upper range limit of the sensor, the detection of contamination is better. A slightly contaminated sensor may read perfectly at lower conductivity, but show significant errors at higher values. This is caused by the early onset of polarization, the factor that limits the upper range of the sensor in any case. Polarization is seen in contaminated sensors, and it is for this reason that there is a sophisticated polarization check built into the FLXA202/FLXA21.

FLXA202/FLXA21 is programmed with the following table of conductivity of Potassium Chloride (KCl) solutions at 25°C. This is used in the Automatic Cell Constant setting calibration feature. (See chapter 9 on calibration) The table is derived from the Standards laid down in “International Recommendation No. 56 of the Organisation Internationale de Métrologie Legale”.

**Table 4 KCl values at 25 °C**

Standard solution	mol/l	mg KCl/kg of solution	Conductivity
1.000 M KCl	1.0	71135.2	111.31 mS/cm
0.100 M KCl	0.1	7419.13	12.852 mS/cm
0.010 M KCl	0.01	745.263	1.4083 mS/cm
0.005 M KCl	0.005	373.29	0.7182 mS/cm
0.002 M KCl	0.002	149.32	0.2916 mS/cm
0.001 M KCl	0.001	74.66	0.1469 mS/cm

If it is more convenient, the user may make solutions from Sodium Chloride (NaCl or common table salt) with the help of the following relationship table. This table is derived from the IEC norm 60746-3.

**Table 5 NaCl values at 25 °C**

Weight %	mg/kg	Conductivity
0.001	10	21.4 µS/cm
0.003	30	64.0 µS/cm
0.005	50	106 µS/cm
0.01	100	210 µS/cm
0.03	300	617 µS/cm
0.05	500	1.03 mS/cm
0.1	1000	1.99 mS/cm
0.3	3000	5.69 mS/cm
0.5	5000	9.48 mS/cm
1	10000	17.6 mS/cm
3	30000	48.6 mS/cm
5	50000	81.0 mS/cm
10	100000	140 mS/cm

For resistivity measurement the standard resistivity units of the calibration solution can be calculated as follows:

$$R = 1000/G \text{ (k}\Omega\cdot\text{cm if } G = \mu\text{S/cm)}$$

$$\text{Example: 0.001\% weight} \quad R = 1000/21.4 = 46.7 \text{ k}\Omega\cdot\text{cm}$$

## ■ Monitoring of Purified Water and WFI according to USP<645>

First published in the USP23 (The United States Pharmacopeia, ed. 23), the USP <645> describes a procedure of measuring the conductivity of Purified Water and WFI (Water for Injection) instead of the previous complicated monitoring procedure. This procedure consists of three stages for measuring the conductivity of Purified Water and WFI. On the stage 1, firstly the temperature of the water and the non-temperature-compensated conductivity of the water are measured, and this conductivity is compared with the limit conductivity value of the corresponding temperature directed by USP<645>. (Refer to Figure 3.) If the conductivity is higher than the limit value, the procedure will proceed to the stage 2.

The FLXA202/FLXA21 has the limit values of USP<645> built in the firmware. When the error configuration is set for this monitoring, the FLXA202/FLXA21 checks the non-temperature-compensated conductivity with the limit value. If the conductivity is higher than the limit value, an error will be generated. A safety margin to the limit value can be set on the FLXA202/FLXA21 to generate an error below limit value. (Refer to the section 7.3.)

When the safety margin is set at 20%, for example, an error will be generated when the non-temperature-compensated conductivity goes higher than the 80% of the limit value at all temperatures. For example, if the temperature is 64 °C. and the safety margin is set at 20%, then an error will be generated at  $0.8 \times 2.2 \mu\text{S/cm} = 1.76 \mu\text{S/cm}$ . (2.2 µS/cm is the USP<645> limit value at 64°C). In resistivity mode, an error will be generated at a non-temperature-compensated resistivity of 0.568 MΩ (=1/1.76 µS/cm).

App.

SC

The USP<645> limit value is a non-temperature-compensated conductivity. When a measuring conductivity needs to be shown on the main or home display as a non-temperature-compensated conductivity, set the temperature compensation on “None”. (Refer to the section 7.1.4.)

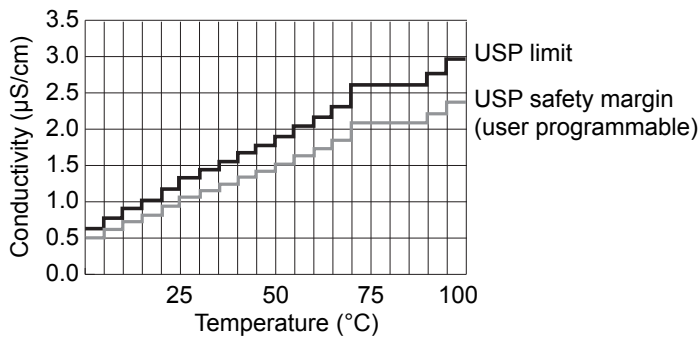

Figure 3 Conductivity limit value and temperature directed by USP<645>

## ■ Changing the settings

If any setting is accidentally changed, values to the right of the relevant arrow in Table 6 are all initialized.

Table 6 Parameters that initialize other values

Measurement ->	Output: Process parameter ->	Linear: 0% value, 100% value
		Table
		Communication: HART: PV
	Display setup: Individual display (Main display)	
	Trend Graph Screen ->	Y-axis (low, high)
Communication: HART		
Configure sensor: Measuring unit ->	Display setup: Individual display (Main display): unit	



# Appendix 3 For ISC (Inductive Conductivity)

## ■ Temperature compensation

The conductivity of a solution is very dependent on temperature. Typically for every 1°C change in temperature the solution conductivity will change by approximately 2%. The effect of temperature varies from one solution to another and is determined by several factors like solution composition, concentration and temperature range. A coefficient ( $\alpha$ ) is introduced to express the amount of temperature influence in % change in conductivity/°C. In almost all applications this temperature influence must be compensated before the conductivity reading can be interpreted as an accurate measure of concentration or purity.

### ● NaCl (standard temperature compensation)

The FLXA202/FLXA21 has the default temperature compensation function based on a sodium chloride (NaCl) solution. This function can be used for various applications and is compatible with the NaCl compensation function of typical laboratory or portable instruments.

**Table 1 NaCl compensation according to IEC 60746-3 with Tref. = 25°C**

Temperature (°C)	Ratio*	Temperature compensation coefficient (%/°C)	Temperature (°C)	Ratio*	Temperature compensation coefficient (%/°C)
0	0.54	1.8	100	2.68	2.2
10	0.72	1.9	110	2.90	2.2
20	0.90	2.0	120	3.12	2.2
25	1.00	—	130	3.34	2.2
30	1.10	2.0	140	3.56	2.2
40	1.31	2.0	150	3.79	2.2
50	1.53	2.1	160	4.03	2.2
60	1.76	2.2	170	4.23	2.2
70	1.99	2.2	180	4.42	2.2
80	2.22	2.2	190	4.61	2.2
90	2.45	2.2	200	4.78	2.2

\*: The ratio of the conductivity at respective temperatures to the conductivity at the reference temperature.

### ● Temperature compensation coefficient (TC)

Set the temperature compensation coefficient based on the degree of influence of temperature on the conductivity (%/°C).

If the temperature compensation coefficient of the sample solution is known from laboratory experiments or has been previously determined, enter the value.

The setting range is between 0.00 and 10.0%. By combining with the reference temperature setting, a linear compensation function can be obtained. This is applicable to all kinds of chemical solution.

#### <Configure calculated temperature coefficient (TC).>

Follow routing

Commissioning >> Measurement setup >> Temp.compensation >> T.C.

Enter the temperature coefficient calculated from the following formula:

App.

ISC



**A. Calculation of temperature coefficient factor (With known conductivity at reference temperature).**

$$\alpha = \frac{K_t - K_{ref}}{T - T_{ref}} \times \frac{100}{K_{ref}}$$

$\alpha$  = Temperature compensation factor in %/°C

T = Measured temperature in °C

$K_t$  = Conductivity at T

$T_{ref}$  = Reference temperature

$K_{ref}$  = Conductivity at  $T_{ref}$

**B. Calculation of temperature coefficient factor (with two known conductivity values at different temperatures)**

Measure the conductivity of the liquid at two temperatures, one below the reference and above the reference temperature with the temperature coefficient set to 0,00%/°C and use the following equation to calculate a temperature coefficient ( $\alpha$ ).

$$K_{ref} = \frac{K_T}{1 + \alpha (T - T_{ref})}$$

$$K_{ref} = \frac{K_1}{1 + \alpha (T_1 - T_{ref})} = \frac{K_2}{1 + \alpha (T_2 - T_{ref})}$$

$$K_1(1 + \alpha (T_2 - T_{ref})) = K_2(1 + \alpha (T_1 - T_{ref}))$$

$$K_1 \cdot \alpha (T_2 - T_{ref}) - K_2 \cdot \alpha (T_1 - T_{ref}) = K_2 - K_1$$

$$\alpha = \frac{K_2 - K_1}{K_1(T_2 - T_{ref}) - K_2(T_1 - T_{ref})}$$

Where  $T_1, T_2$ : liquid temperature (°C)

$K_1$ : conductivity at  $T_1$  (°C)

$K_2$ : conductivity at  $T_2$  (°C)

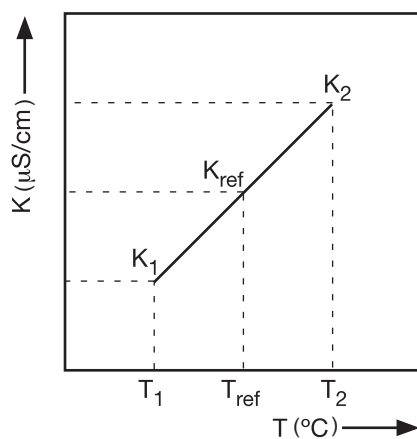

Figure 1 Conductivity

## &lt;Calculation example&gt;

Calculate the temperature coefficient of a liquid from the following data.

Conductivity 124.5  $\mu\text{S}/\text{cm}$  at a liquid temperature of 18.0 °C and a conductivity 147.6  $\mu\text{S}/\text{cm}$  at a liquid temperature of 31.0 °C.

Substituting the data in the above formula gives the following result.

$$\alpha = \frac{147.6 - 124.5}{124.5 \times (31.0 - 25) - 147.6 \times (18.0 - 25)} \times 100 = 1.298 \text{ \%/}^\circ\text{C}$$

Set the temperature coefficient in the FLXA202/FLXA21 converter.

When the temperature coefficient already set is accurate, the conductivity to be displayed must be constant regardless of liquid temperature. The following check will make sure that the temperature coefficient already set is accurate.

If, when the liquid temperature is lowered, a larger conductivity value is indicated, the temperature coefficient already set is too small.

The opposite also applies. If a smaller conductivity value is indicated, the temperature coefficient already set is too large. In either case, change the temperature coefficient so that the conductivity no longer changes.

## ● Matrix

Matrix means temperature compensation with the temperature compensation matrix.

The temperature compensation matrix is a table of conductivity values at different temperatures and concentrations.

Ready-made matrixes and user-defined matrixes are available.

### <Ready-made matrixes>

Ready-made temperature compensation matrixes are available for common inorganic acids and bases.

**Table 2 Ready-made temperature compensation matrixes**

Select matrix	Compound to be measured	Concentration	Temperature	Details
Sulfonic acid 1..5%	H <sub>2</sub> SO <sub>4</sub>	1 to 5%	0 to 100°C	Table A
Sulfonic acid 0..27%	H <sub>2</sub> SO <sub>4</sub>	0 to 27%	-1.1 to 98.9°C	Table B
Sulfonic acid 39..85%	H <sub>2</sub> SO <sub>4</sub>	39 to 85%	-17.8 to 115.6°C	Table C
Sulfonic acid 93..100%	H <sub>2</sub> SO <sub>4</sub>	93 to 100%	10 to 90°C	Table D
HCl 1..5%	HCl	1 to 5%	0 to 60°C	Table E
HCl 0..18%	HCl	0 to 18.2%	-10 to 65°C	Table F
HCl 24..44%	HCl	23.7 to 43.8%	-20 to 65°C	Table G
HNO <sub>3</sub> 1..5%	HNO <sub>3</sub>	1 to 5%	0 to 80°C	Table H
HNO <sub>3</sub> 0..25%	HNO <sub>3</sub>	0 to 24.80%	0 to 80°C	Table I
HNO <sub>3</sub> 35..88%	HNO <sub>3</sub>	35.0 to 87.7%	-16 to 60°C	Table J
NaOH 1..5%	NaOH	1 to 5%	0 to 100°C	Table K
NaOH 0..15%	NaOH	0 to 15%	0 to 100°C	Table L
NaOH 25..50%	NaOH	25 to 50%	0 to 80°C	Table M

The ready-made temperature compensation matrixes are listed in Table A to M where temperatures are in the column and concentrations are in the rows.

Table A Sulfonic acid 1..5% (Conductivity unit: S/cm)

Solutions (Conc.)		Solut. Min.	Solu-tion 2	Solu-tion 3	Solu-tion 4	Solu-tion 5	Solu-tion 6	Solu-tion 7	Solu-tion 8	Solu-tion 9	Solut. Max.
Temp.ranges		1.0 %	1.5 %	2.0 %	2.5 %	3.0 %	3.3 %	3.7 %	4.0 %	4.5 %	5.0 %
Tmin.	0 °C	0.0338	0.0487	0.0635	0.0793	0.0950	0.105	0.115	0.124	0.139	0.154
2.	10 °C	0.0391	0.0571	0.0750	0.0931	0.111	0.123	0.134	0.146	0.163	0.180
3.	20 °C	0.0444	0.0655	0.0865	0.107	0.127	0.141	0.154	0.167	0.186	0.205
4.	30 °C	0.0491	0.0727	0.0963	0.119	0.141	0.156	0.172	0.186	0.207	0.228
5.	40 °C	0.0533	0.0789	0.104	0.129	0.154	0.170	0.187	0.203	0.226	0.249
6.	50 °C	0.0575	0.0850	0.113	0.139	0.166	0.184	0.202	0.220	0.245	0.270
7.	63 °C	0.0606	0.0899	0.119	0.148	0.177	0.196	0.216	0.235	0.262	0.289
8.	75 °C	0.0637	0.0949	0.126	0.157	0.189	0.209	0.229	0.249	0.278	0.307
9.	88 °C	0.0659	0.0988	0.132	0.165	0.197	0.218	0.240	0.261	0.291	0.322
Tmax.	100 °C	0.0680	0.103	0.138	0.172	0.206	0.228	0.251	0.273	0.305	0.336
Tref.	25.0 °C	0.0470	0.0697	0.0923	0.114	0.135	0.149	0.164	0.178	0.198	0.218

Table B Sulfonic acid 0..27% (Conductivity unit: S/cm)

Solutions (Conc.)		Solut. Min.	Solu-tion 2	Solu-tion 3	Solu-tion 4	Solu-tion 5	Solu-tion 6	Solu-tion 7	Solu-tion 8	Solu-tion 9	Solut. Max.
Temp.ranges		0 %	5 %	8 %	12 %	14 %	17 %	20 %	22 %	24 %	27 %
Tmin.	-1.1 °C	0	0.1496	0.2330	0.3275	0.3695	0.4225	0.4640	0.4850	0.5005	0.5140
2.	10.0 °C	0	0.1813	0.3845	0.4030	0.4355	0.5210	0.5725	0.5980	0.6160	0.6340
3.	21.1 °C	0	0.2102	0.3330	0.4740	0.5335	0.6145	0.6805	0.7140	0.7385	0.7625
4.	32.2 °C	0	0.2351	0.3740	0.5360	0.6070	0.7030	0.7810	0.8225	0.8540	0.8860
5.	43.3 °C	0	0.2574	0.4130	0.5945	0.6735	0.7835	0.8755	0.9250	0.9635	1.0050
6.	54.4 °C	0	0.2674	0.4450	0.6455	0.7315	0.8533	0.9600	1.0190	1.0660	1.1180
7.	60.0 °C	0	0.2853	0.4600	0.6670	0.7570	0.8860	0.9980	1.0600	1.1110	1.1700
8.	71.1 °C	0	0.3007	0.4860	0.7070	0.8060	0.9470	1.0710	1.1400	1.1970	1.2640
9.	87.8 °C	0	0.3217	0.5210	0.7605	0.8665	1.0250	1.1630	1.2420	1.3100	1.3940
Tmax.	98.9 °C	0	0.3335	0.5420	0.7885	0.9025	1.0650	1.2160	1.3020	1.3760	1.4690
Tref.	25.0 °C	0	0.2190	0.3470	0.4960	0.5590	0.6450	0.7160	0.7520	0.7790	0.8060

Table C Sulfonic acid 39..85% (Conductivity unit: S/cm)

Solutions (Conc.)		Solut. Min.	Solu-tion 2	Solu-tion 3	Solu-tion 4	Solu-tion 5	Solu-tion 6	Solu-tion 7	Solu-tion 8	Solu-tion 9	Solut. Max.
Temp.ranges		39 %	44 %	50 %	55 %	60 %	65 %	70 %	75 %	80 %	85 %
Tmin.	-17.8 °C	0.2775	0.2500	0.2125	0.1770	0.1385	0.1020	0.0710	0.0435	0.0140	0
2.	4.4 °C	0.5225	0.4695	0.4000	0.3265	0.2750	0.2105	0.1500	0.0990	0.0655	0.0610
3.	21.1 °C	0.7220	0.6590	0.5700	0.4670	0.3950	0.3085	0.2315	0.1650	0.1200	0.1100
4.	32.2 °C	0.8600	0.7895	0.6870	0.5715	0.4870	0.3850	0.2950	0.2190	0.1655	0.1530
5.	43.3 °C	0.9225	0.9190	0.8080	0.6770	0.5830	0.4670	0.3640	0.2785	0.2190	0.2040
6.	54.4 °C	1.1250	1.0510	0.9305	0.7825	0.6770	0.5505	0.4400	0.3475	0.2825	0.2620
7.	65.6 °C	1.2490	1.1760	1.0530	0.8950	0.7810	0.6430	0.5220	0.4210	0.3495	0.3255
8.	82.2 °C	1.4340	1.3670	1.2370	1.0640	0.9390	0.7900	0.6570	0.5430	0.4620	0.4315
9.	98.9 °C	1.5950	1.5400	1.4150	1.2350	1.1000	0.9370	0.7960	0.6750	0.5880	0.5450
Tmax.	115.6 °C	1.7350	1.6920	1.5660	1.4250	1.2600	1.0910	0.9345	0.8110	0.7190	0.6630
Tref.	25.0 °C	0.7700	0.7050	0.6110	0.5040	0.4270	0.3350	0.2530	0.1840	0.1360	0.1250

Table D Sulfonic acid 93..100% (Conductivity unit: S/cm)

Solutions (Conc.) Temp.ranges		Solut. Min.	Solu- tion 2	Solu- tion 3	Solu- tion 4	Solu- tion 5	Solu- tion 6	Solu- tion 7	Solu- tion 8	Solu- tion 9	Solut. Max.
		93.0 %	94.0 %	95.0 %	95.5 %	96.0 %	97.0 %	97.5 %	98.0 %	99.0 %	100.0 %
Tmin.	10 °C	0.0860	0.0835	0.0800	0.0768	0.0735	0.0640	0.0563	0.0485	0.0225	0
2.	20 °C	0.1153	0.1143	0.1110	0.1086	0.1051	0.0961	0.0895	0.0812	0.0580	0.0085
3.	25 °C	0.1320	0.1310	0.1260	0.1230	0.1190	0.1090	0.1020	0.0920	0.0640	0.0105
4.	30 °C	0.1490	0.1467	0.1414	0.1375	0.1332	0.1220	0.1138	0.1035	0.0703	0.0125
5.	40 °C	0.1897	0.1860	0.1787	0.1739	0.1680	0.1520	0.1410	0.1295	0.0869	0.0171
6.	50 °C	0.2323	0.2275	0.2190	0.2124	0.2041	0.1833	0.1710	0.1574	0.1067	0.0219
7.	60 °C	0.2787	0.2715	0.2604	0.2530	0.2440	0.2200	0.2053	0.1884	0.1275	0.0279
8.	70 °C	0.3284	0.3196	0.3065	0.2970	0.2853	0.2594	0.2420	0.2255	0.1495	0.0240
9.	80 °C	0.3826	0.3714	0.3550	0.3450	0.3332	0.3015	0.2813	0.2570	0.1732	0.0404
Tmax.	90 °C	0.4390	0.4250	0.4050	0.3923	0.3775	0.3405	0.3175	0.2910	0.1975	0.0460
Tref.	25.0 °C	0.1320	0.1310	0.1260	0.1230	0.1190	0.1090	0.1020	0.0920	0.0640	0.0105

Table E HCl 1..5% (Conductivity unit: S/cm)

Solutions (Conc.) Temp.ranges		Solut. Min.	Solu- tion 2	Solu- tion 3	Solu- tion 4	Solu- tion 5	Solu- tion 6	Solu- tion 7	Solu- tion 8	Solu- tion 9	Solut. Max.
		1.0 %	1.5 %	2.0 %	2.5 %	3.0 %	3.3 %	3.7 %	4.0 %	4.5 %	5.0 %
Tmin.	0 °C	0.0650	0.0950	0.125	0.152	0.179	0.196	0.213	0.229	0.251	0.273
2.	5 °C	0.0737	0.107	0.141	0.172	0.202	0.221	0.240	0.258	0.283	0.308
3.	10 °C	0.0823	0.120	0.157	0.191	0.225	0.246	0.267	0.288	0.316	0.344
4.	15 °C	0.0910	0.132	0.173	0.211	0.248	0.271	0.294	0.317	0.348	0.379
5.	20 °C	0.0987	0.143	0.188	0.229	0.270	0.295	0.320	0.345	0.378	0.412
6.	30 °C	0.114	0.166	0.217	0.265	0.313	0.342	0.372	0.401	0.439	0.477
7.	38 °C	0.125	0.182	0.239	0.290	0.342	0.373	0.406	0.438	0.479	0.521
8.	45 °C	0.135	0.198	0.260	0.315	0.370	0.404	0.440	0.474	0.520	0.565
9.	53 °C	0.147	0.214	0.281	0.340	0.400	0.437	0.475	0.512	0.564	0.616
Tmax.	60 °C	0.159	0.230	0.301	0.366	0.430	0.469	0.510	0.549	0.608	0.666
Tref.	25.0 °C	0.106	0.154	0.202	0.247	0.291	0.318	0.346	0.373	0.409	0.444

Table F HCl 0..18% (Conductivity unit: S/cm)

Solutions (Conc.) Temp.ranges		Solut. Min.	Solu- tion 2	Solu- tion 3	Solu- tion 4	Solu- tion 5	Solu- tion 6	Solu- tion 7	Solu- tion 8	Solu- tion 9	Solut. Max.
		0 %	3.65 %	5.48 %	7.30 %	9.12 %	11.0 %	12.8 %	14.6 %	16.4 %	18.2 %
Tmin.	-10 °C	0	0.174	0.226	0.277	0.329	0.362	0.390	0.409	0.427	0.439
2.	0 °C	0	0.212	0.294	0.364	0.421	0.464	0.489	0.514	0.538	0.552
3.	10 °C	0	0.262	0.362	0.445	0.512	0.566	0.603	0.629	0.654	0.668
4.	15 °C	0	0.284	0.395	0.481	0.554	0.610	0.653	0.681	0.708	0.722
5.	20 °C	0	0.312	0.431	0.526	0.600	0.658	0.706	0.737	0.768	0.783
6.	25 °C	0	0.332	0.459	0.563	0.647	0.713	0.764	0.794	0.824	0.837
7.	30 °C	0	0.359	0.497	0.607	0.692	0.760	0.815	0.850	0.885	0.901
8.	45 °C	0	0.425	0.587	0.721	0.830	0.914	0.978	1.02	1.06	1.08
9.	55 °C	0	0.468	0.648	0.796	0.917	1.01	1.08	1.13	1.17	1.17
Tmax.	65 °C	0	0.509	0.705	0.867	1.00	1.10	1.18	1.23	1.28	1.31
Tref.	25.0 °C	0	0.332	0.459	0.563	0.647	0.713	0.764	0.794	0.824	0.837

App.

ISC

Table G HCl 24.44% (Conductivity unit: S/cm)

Solutions (Conc.) Temp.ranges		Solut. Min.	Solu- tion 2	Solu- tion 3	Solu- tion 4	Solu- tion 5	Solu- tion 6	Solu- tion 7	Solu- tion 8	Solu- tion 9	Solut. Max.
		23.7 %	25.6 %	29.2 %	31.0 %	32.8 %	34.7 %	36.5 %	38.3 %	40.1 %	43.8 %
Tmin.	-20 °C	0.354	0.351	0.342	0.335	0.328	0.319	0.312	0.303	0.295	0.277
2.	0 °C	0.560	0.555	0.538	0.524	0.511	0.497	0.482	0.467	0.452	0.424
3.	10 °C	0.670	0.661	0.635	0.620	0.604	0.587	0.570	0.553	0.537	0.504
4.	15 °C	0.722	0.712	0.685	0.669	0.652	0.635	0.616	0.597	0.579	0.540
5.	20 °C	0.783	0.771	0.739	0.720	0.700	0.679	0.658	0.637	0.617	0.576
6.	25 °C	0.830	0.818	0.786	0.768	0.748	0.728	0.707	0.686	0.662	0.622
7.	30 °C	0.898	0.885	0.849	0.827	0.805	0.782	0.759	0.736	0.714	0.667
8.	45 °C	1.07	1.06	1.01	0.989	0.964	0.938	0.911	0.883	0.855	0.797
9.	55 °C	1.19	1.17	1.12	1.09	1.06	1.03	1.00	0.970	0.940	0.910
Tmax.	65 °C	1.30	1.28	1.23	1.20	1.17	1.14	1.11	1.08	1.05	1.02
Tref.	25.0 °C	0.830	0.818	0.786	0.768	0.748	0.728	0.707	0.686	0.662	0.622

Table H HNO<sub>3</sub> 1.5% (Conductivity unit: S/cm)

Solutions (Conc.) Temp.ranges		Solut. Min.	Solu- tion 2	Solu- tion 3	Solu- tion 4	Solu- tion 5	Solu- tion 6	Solu- tion 7	Solu- tion 8	Solu- tion 9	Solut. Max.
		1.0%	1.5 %	2.0 %	2.5 %	3.0 %	3.3 %	3.7 %	4.0 %	4.5 %	5.0 %
Tmin.	0 °C	0.0395	0.0578	0.0761	0.0948	0.1134	0.1246	0.1360	0.1472	0.1634	0.1795
2.	10 °C	0.0485	0.0704	0.0923	0.1149	0.1374	0.1510	0.1650	0.1786	0.1987	0.2188
3.	15 °C	0.0529	0.0767	0.1004	0.1249	0.1494	0.1642	0.1795	0.1943	0.2163	0.2384
4.	20 °C	0.0574	0.0830	0.1085	0.1350	0.1614	0.1774	0.1940	0.2100	0.2340	0.2580
5.	30 °C	0.0694	0.0989	0.1283	0.1583	0.1882	0.2061	0.2246	0.2425	0.2683	0.2940
6.	40 °C	0.0814	0.1148	0.1481	0.1816	0.2150	0.2348	0.2552	0.2750	0.3025	0.3300
7.	50 °C	0.0907	0.1276	0.1645	0.2010	0.2375	0.2591	0.2814	0.3030	0.3333	0.3635
8.	60 °C	0.0999	0.1404	0.1808	0.2204	0.2600	0.2834	0.3076	0.3310	0.3640	0.3970
9.	70 °C	0.1139	0.1564	0.1989	0.2392	0.2795	0.3036	0.3284	0.3525	0.3875	0.4225
Tmax.	80 °C	0.1278	0.1724	0.2170	0.2580	0.2990	0.3238	0.3493	0.3740	0.4110	0.4480
Tref.	25.0 °C	0.0634	0.0909	0.1184	0.1466	0.1748	0.1918	0.2093	0.2263	0.2511	0.2760

Table I HNO<sub>3</sub> 0.25% (Conductivity unit: S/cm)

Solutions (Conc.) Temp.ranges		Solut. Min.	Solu- tion 2	Solu- tion 3	Solu- tion 4	Solu- tion 5	Solu- tion 6	Solu- tion 7	Solu- tion 8	Solu- tion 9	Solut. Max.
		0 %	3.12 %	6.20 %	9.30 %	12.40 %	15.32 %	17.72 %	20.11 %	22.46 %	24.80 %
Tmin.	0 °C	0	0.1140	0.2259	0.3120	0.3980	0.4472	0.4854	0.5236	0.5498	0.5760
2.	18 °C	0	0.1606	0.3178	0.4345	0.5512	0.6062	0.6559	0.7055	0.7368	0.7680
3.	20 °C	0	0.1650	0.3215	0.4395	0.5575	0.6236	0.6742	0.7248	0.7568	0.7888
4.	25 °C	0	0.1780	0.3490	0.4760	0.6030	0.6655	0.7186	0.7717	0.8119	0.8520
5.	30 °C	0	0.1900	0.3665	0.5002	0.6339	0.7065	0.7619	0.8172	0.8555	0.8938
6.	40 °C	0	0.2110	0.4095	0.5588	0.7081	0.7860	0.8451	0.9042	0.9511	0.9980
7.	50 °C	0	0.2600	0.4507	0.6154	0.7801	0.8620	0.9239	0.9857	1.044	1.102
8.	60 °C	0	0.3100	0.4899	0.6699	0.8498	0.9345	0.9982	1.062	1.133	1.205
9.	70 °C	0	0.3330	0.5273	0.7223	0.9173	1.004	1.068	1.132	1.219	1.306
Tmax.	80 °C	0	0.3560	0.5660	0.7770	0.9826	1.069	1.133	1.198	1.302	1.407
Tref.	25.0 °C	0	0.1780	0.3490	0.4760	0.6030	0.6655	0.7186	0.7715	0.8119	0.8520

Table J HNO<sub>3</sub> 35..88% (Conductivity unit: S/cm)

Solutions (Conc.) Temp.ranges		Solut. Min.	Solu- tion 2	Solu- tion 3	Solu- tion 4	Solu- tion 5	Solu- tion 6	Solu- tion 7	Solu- tion 8	Solu- tion 9	Solut. Max.
		35.0 %	37.2 %	43.3 %	49.6 %	55.8 %	62.0 %	75.0 %	76.6 %	82.0 %	87.7 %
Tmin.	-16 °C	0.412	0.400	0.368	0.334	0.288	0.254	0.163	0.147	0.089	0.044
2.	0 °C	0.576	0.555	0.507	0.456	0.404	0.352	0.227	0.208	0.128	0.060
3.	10 °C	0.678	0.666	0.614	0.555	0.493	0.438	0.268	0.246	0.153	0.069
4.	18 °C	0.770	0.754	0.700	0.634	0.565	0.506	0.300	0.277	0.172	0.077
5.	20 °C	0.786	0.776	0.721	0.654	0.583	0.512	0.310	0.290	0.175	0.079
6.	25 °C	0.842	0.831	0.784	0.714	0.636	0.559	0.340	0.315	0.185	0.081
7.	30 °C	0.895	0.886	0.827	0.754	0.672	0.590	0.370	0.335	0.190	0.083
8.	40 °C	1.001	0.995	0.938	0.858	0.774	0.690	0.430	0.375	0.200	0.087
9.	50 °C	1.105	1.095	1.038	0.958	0.874	0.790	0.485	0.415	0.210	0.091
Tmax.	60 °C	1.205	1.195	1.138	1.058	0.974	0.890	0.530	0.455	0.220	0.095
Tref.	25.0 °C	0.842	0.831	0.784	0.714	0.636	0.559	0.340	0.315	0.185	0.081

Table K NaOH 1..5% (Conductivity unit: S/cm)

Solutions (Conc.) Temp.ranges		Solut. Min.	Solu- tion 2	Solu- tion 3	Solu- tion 4	Solu- tion 5	Solu- tion 6	Solu- tion 7	Solu- tion 8	Solu- tion 9	Solut. Max.
		1.0 %	1.5 %	2.0 %	2.5 %	3.0 %	3.3 %	3.7 %	4.0 %	4.5 %	5.0 %
Tmin.	0 °C	0.0310	0.0460	0.0610	0.0735	0.0860	0.0923	0.0987	0.105	0.116	0.127
2.	10 °C	0.0398	0.0584	0.0770	0.0933	0.110	0.119	0.128	0.137	0.151	0.165
3.	20 °C	0.0486	0.0708	0.0930	0.113	0.133	0.145	0.157	0.169	0.186	0.204
4.	30 °C	0.0576	0.0833	0.109	0.133	0.157	0.172	0.187	0.202	0.222	0.242
5.	40 °C	0.0668	0.0959	0.125	0.154	0.182	0.200	0.217	0.235	0.258	0.281
6.	50 °C	0.0760	0.109	0.141	0.174	0.207	0.227	0.248	0.268	0.294	0.319
7.	63 °C	0.0868	0.124	0.162	0.199	0.236	0.258	0.281	0.304	0.334	0.364
8.	75 °C	0.0975	0.140	0.182	0.223	0.264	0.289	0.314	0.339	0.374	0.408
9.	88 °C	0.108	0.155	0.203	0.247	0.291	0.319	0.347	0.375	0.413	0.452
Tmax.	100 °C	0.119	0.171	0.223	0.271	0.318	0.348	0.380	0.410	0.453	0.495
Tref.	25.0 °C	0.0530	0.0770	0.101	0.123	0.145	0.158	0.172	0.185	0.204	0.223

Table L NaOH 0..15% (Conductivity unit: S/cm)

Solutions (Conc.) Temp.ranges		Solut. Min.	Solu- tion 2	Solu- tion 3	Solu- tion 4	Solu- tion 5	Solu- tion 6	Solu- tion 7	Solu- tion 8	Solu- tion 9	Solut. Max.
		0 %	1 %	3 %	4 %	5 %	6 %	8 %	10 %	12 %	15 %
Tmin.	0 °C	0	0.035	0.087	0.113	0.133	0.150	0.176	0.195	0.206	0.215
2.	10 °C	0	0.042	0.109	0.140	0.167	0.190	0.226	0.255	0.274	0.293
3.	18 °C	0	0.047	0.125	0.163	0.195	0.221	0.267	0.303	0.327	0.345
4.	25 °C	0	0.052	0.142	0.183	0.222	0.256	0.313	0.355	0.381	0.410
5.	30 °C	0	0.056	0.153	0.200	0.242	0.278	0.338	0.389	0.424	0.467
6.	40 °C	0	0.063	0.179	0.233	0.281	0.323	0.396	0.458	0.502	0.551
7.	50 °C	0	0.070	0.201	0.265	0.320	0.368	0.454	0.527	0.580	0.645
8.	60 °C	0	0.080	0.223	0.293	0.355	0.410	0.507	0.592	0.658	0.742
9.	80 °C	0	0.100	0.270	0.350	0.425	0.493	0.612	0.721	0.814	0.936
Tmax.	100 °C	0	0.119	0.315	0.407	0.495	0.574	0.717	0.850	0.967	1.130
Tref.	25.0 °C	0	0.052	0.142	0.183	0.222	0.256	0.313	0.355	0.381	0.410

App.

ISC

Table M NaOH 25..50% (Conductivity unit: S/cm)

Solutions (Conc.)		Solut. Min.	Solu- tion 2	Solu- tion 3	Solu- tion 4	Solu- tion 5	Solu- tion 6	Solu- tion 7	Solu- tion 8	Solu- tion 9	Solut. Max.
		25 %	28 %	30 %	32 %	35 %	38 %	40 %	42 %	45 %	50 %
Tmin.	0 °C	0.140	0.100	0.075	0.060	0.040	0.024	0.017	0.012	0.010	0.007
2.	10 °C	0.212	0.174	0.148	0.124	0.094	0.074	0.063	0.053	0.038	0.025
3.	18 °C	0.270	0.232	0.207	0.184	0.153	0.131	0.120	0.105	0.090	0.078
4.	25 °C	0.352	0.313	0.289	0.266	0.233	0.207	0.194	0.180	0.162	0.146
5.	30 °C	0.411	0.372	0.347	0.323	0.291	0.264	0.248	0.233	0.214	0.195
6.	40 °C	0.528	0.489	0.463	0.440	0.405	0.373	0.354	0.337	0.317	0.293
7.	50 °C	0.645	0.605	0.580	0.556	0.520	0.482	0.460	0.441	0.420	0.390
8.	60 °C	0.796	0.766	0.746	0.724	0.694	0.660	0.639	0.623	0.604	0.570
9.	75 °C	1.023	1.007	0.995	0.980	0.955	0.925	0.908	0.893	0.873	0.839
Tmax.	80 °C	1.098	1.086	1.078	1.066	1.042	1.015	0.997	0.982	0.963	0.929
Tref.	25.0 °C	0.352	0.313	0.289	0.266	0.233	0.207	0.194	0.180	0.162	0.146

<User-defined matrixes>

The user-defined temperature compensation matrix is a matrix defined by users. Enter values as shown in Table 3. The gray areas must be entered.

Table 3 Example of user-defined matrix (Reference temperature (Tref.): 25.0 °C, Conductivity unit: S/cm)

Solutions (Conc.)		Solut. Min.	Solut. Max.	Solu- tion 2	Solu- tion 3	Solu- tion 4	Solu- tion 5	Solu- tion 6	Solu- tion 7	Solu- tion 8	Solu- tion 9
		0 %	15 %	1 %	3 %	4 %	5 %	6 %	8 %	10 %	12 %
Tref.	(25.0 °C)	0.013	0.410	0.052	0.142	0.183	0.222	0.256	0.313	0.355	0.381
Tmin.	0 °C	0.009	0.215	0.035	0.087	0.113	0.133	0.150	0.176	0.195	0.206
Tmax.	100 °C	0.025	1.13	0.119	0.315	0.407	0.495	0.574	0.717	0.850	0.967
2.	10 °C	0.010	0.293	0.042	0.109	0.140	0.167	0.190	0.226	0.255	0.274
3.	18 °C	0.012	0.357	0.047	0.125	0.163	0.195	0.221	0.267	0.303	0.327
4.	25 °C	0.013	0.410	0.052	0.142	0.183	0.222	0.256	0.313	0.355	0.381
5.	30 °C	0.014	0.468	0.056	0.153	0.200	0.242	0.278	0.338	0.389	0.424
6.	40 °C	0.015	0.551	0.067	0.179	0.233	0.281	0.323	0.396	0.458	0.502
7.	50 °C	0.017	0.645	0.070	0.201	0.265	0.320	0.368	0.454	0.527	0.580
8.	60 °C	0.018	0.742	0.080	0.223	0.293	0.355	0.410	0.507	0.592	0.658
9.	80 °C	0.021	0.936	0.100	0.270	0.350	0.425	0.493	0.612	0.721	0.814

Note: This table is as shown on the screen. The gray areas must be entered.

Set the reference temperature in the Temp. comp. screen (default: 25.0°C).

Input concentration values in the Solution screen.

The values must be entered in ascending order from Solution (Min.) to Solution (Max.). Solution (Min.) and Solution (Max.) must be entered.

Input temperatures for compensation in the Temp. ranges screen.

Input the conductivity values\* at respective temperatures in the Solution (Min.) screen and those in the Solution (Max.) screen. Input other values, if any, in the Solution n screen.

\*: Enter the precompensated conductivity.

All cells of two user-defined matrixes are blank as a default. If any cells are not blank, clear them.

After entering all values, select "Check values?" to verify that there is no error.

This function checks if the matrix is consistently incremental or decremental. If any error is found, its location is specified.

If there is no error, the matrix is compensated linearly and the blanks of the table (if any) are filled. If some areas are left empty without running "Check values?", a 1st/2nd comp. matrix error will be issued.



## ■ Temperature compensation error

The temperature compensation error (alarm) is issued in any of the following cases.

### ● TC

The error is issued when:

(measured temperature – reference temperature) < –90/compensation coefficient

The default of the temperature compensation coefficient is 2.10%/°C.

For example, when the reference temperature is 25°C, the temperature compensation coefficient is 2.10%/°C and the measured temperature is lower than –17.9°C, the error will be issued.

Temperature compensation is performed even while an alarm is being issued.

### ● Matrix

The error is issued when the temperature or the precompensated conductivity is out of the range of the temperature compensation matrix.

In this case, however, the temperature compensation is performed by extrapolation even while an alarm is being issued.

### ● All

When the conductivity is around zero, the temperature compensation error may be issued. In this case, the temperature compensation is not performed, and the precompensated conductivity is displayed.

Whether the conductivity is around zero or not is determined by the temperature and conductivity of solutions. For example, when the temperature is 20°C and the conductivity is lower than 0.033 µS/cm, the conductivity is determined to be around zero.

When measuring the conductivity around zero in air calibration or when the conductivity to be measured is around zero, an alarm may be issued.

## NOTE

To display the precompensated conductivity, set the Method to “None”.

Select Measurement setup → Temp. compensation.

## ■ Calibration solutions for conductivity

The calibration (cell constant) of a sensor does not change unless the sensor is damaged.

It can also appear to change because of coating of the electrodes, or partial blockage.

It does not make sense to regularly recalibrate the FLXA202/FLXA21.

A calibration check, however, is another matter. When the objective is clearly defined as a diagnostic exercise a regular check can bring an extra level of security and confidence to the measurement.

Sensor damage, and/or coatings can be difficult to see and the calibration check can confirm their presence, by a deviation from the known solution conductivity. The remedial action should be to clean the sensor, and carefully check for blockage or damage (not simply to recalibrate).

Higher conductivity solutions should be used where possible. The lower the conductivity of the test solution, the easier it is to contaminate. Carbon dioxide from the air can be quickly absorbed to cause an error. All containers must be suitably clean, and all materials suitably pure. Outside of a well-equipped laboratory these conditions are hard to meet.



FLXA202/FLXA21 is programmed with the following table of conductivity of Potassium Chloride (KCl) solutions at 25°C. This is used in the Automatic Cell Constant setting calibration feature. (See section 11.2) The table is derived from the Standards laid down in “International Recommendation No. 56 of the Organisation Internationale de Métrologie Legale”.

**Table 4 KCl values at 25 °C**

mol/l	mg KCl/kg of solution	Conductivity
0.001	74.66	0.1469 mS/cm
0.002	149.32	0.2916 mS/cm
0.005	373.29	0.7182 mS/cm
0.01	745.263	1.4083 mS/cm
0.1	7419.13	12.852 mS/cm
1.0	71135.2	111.31 mS/cm

If it is more convenient, the user may make solutions from Sodium Chloride (NaCl or common table salt) with the help of the following relationship table. This table is derived from the IEC norm 60746-3.

**Table 5 NaCl values at 25 °C**

Weight %	mg/kg	Conductivity
0.001	10	21.4 μS/cm
0.003	30	64.0 μS/cm
0.005	50	106 μS/cm
0.01	100	210 μS/cm
0.03	300	617 μS/cm
0.05	500	1.03 mS/cm
0.1	1000	1.99 mS/cm
0.3	3000	5.69 mS/cm
0.5	5000	9.48 mS/cm
1	10000	17.6 mS/cm
3	30000	48.6 mS/cm
5	50000	81.0 mS/cm
10	100000	140 mS/cm

## ■ Measurement principle

Contrary to contact electrode conductivity, the EXA ISC Series analyses the conductivity without any contact between electrodes and process fluid. The measurement is based on inductive coupling of 2 ring transformers (Toroids) by the liquid.

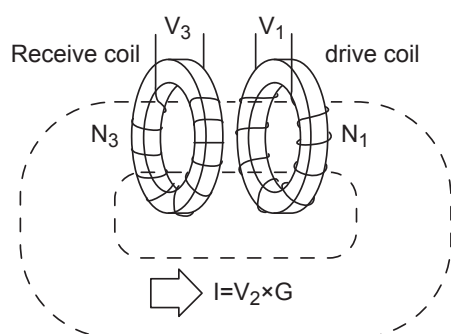

The converter supplies a reference voltage at a high frequency to the “drive coil”. The core of this coil is of a high permeability magnetic material, and a strong magnetic field is generated in the toroid.

The liquid passes through the hole in the toroid and can be considered as a “one turn” secondary winding.

The magnetic field will induce a voltage in this secondary winding. The induced current in the liquid winding is proportional to this voltage and the conductance of the liquid “one turn winding” is according to Ohm’s law.

The conductance ( $1/R$ ) is proportional to the specific conductivity and a constant factor that is determined by the geometry of the sensor (length divided by surface area of the hole in the toroid) and the installation of the sensor.

There are 2 toroids mounted in the “dough nut” shaped sensor. The liquid also flows through the second toroid and therefore the liquid turn can be considered as a primary winding of the second ring transformer.

The current in the liquid will create a magnetic field in the second toroid. The induced voltage being the result of this magnetic field can be measured as an output.

The output voltage of this “receive coil” is therefore proportional to the specific conductivity of the process liquid.

## ■ Changing the settings

If any setting is accidentally changed, values to the right of the relevant arrow in Table 6 are all initialized.

**Table 6 Parameters that initialize other values**

Measurement ->	Output: Process parameter ->	Linear: 0% value, 100% value
		Table
		Communication: HART: PV
	Display setup: Main display	
	Trend Graph Screen ->	Y-axis (low, high)
	Communication: HART	
Configure sensor: Measuring unit ->	Display setup: Main display: unit	



# Appendix 4 For DO (Dissolved Oxygen)

## ■ Dissolved oxygen

Dissolved oxygen means the oxygen dissolved in water.

Its concentration is expressed as the amount of oxygen per unit volume of water (mg/L or ppm).

The solubility of oxygen in water varies depending on water temperature, salinity, atmospheric pressure, etc.

The sensors used in FLXA202/FLXA21 use the membrane electrode method to measure the dissolved oxygen.

Two methods are available: galvanic cell method and polarographic method.

## ■ Compensation

There are three compensation methods for FLXA202/FLXA21: temperature compensation, salinity compensation, and process pressure compensation.

Salinity and temperature compensations meet ISO 5814 (see Table 1).

There is no need to change the setting for normal usage.

Use the salinity compensation when measuring a solution containing salt (see Section 13.2.4).

For operation at high altitude, adjust the pressure value for the process pressure compensation (see Section 13.2.5).

**Table 1 Solubility of oxygen in water as a function of temperature and salinity**

Temperature (°C)	Solubility of oxygen in water in equilibrium with air at 101.325 kPa (mg/l)	Correction to be subtracted for each degree of salinity expressed in g/kg of total salts (NaCl) in water (mg/l)
0	14.62	0.0875
1	14.22	0.0843
2	13.83	0.0818
3	13.46	0.0789
4	13.11	0.0760
5	12.77	0.0739
6	12.45	0.0714
7	12.14	0.0693
8	11.84	0.0671
9	11.56	0.0650
10	11.29	0.0632
11	11.03	0.0614
12	10.78	0.0593
13	10.54	0.0582
14	10.31	0.0561
15	10.08	0.0545
16	9.87	0.0532
17	9.66	0.0514
18	9.47	0.0500
19	9.28	0.0489
20	9.09	0.0475
21	8.91	0.0464
22	8.74	0.0453
23	8.58	0.0443
24	8.42	0.0432
25	8.26	0.0421
26	8.11	0.0407
27	7.97	0.0400
28	7.83	0.0389
29	7.69	0.0382
30	7.56	0.0371

ISO 5814:1990(E)

App.

DO

**Table 2 Solubility of oxygen in water as a function of temperature and pressure**

Temperature (°C)	Pressure [kPa (atm) *1]						
	111.5 (1.1)	101.3 (1.0)	91.2 (0.9)	81.1 (0.8)	70.9 (0.7)	60.8 (0.6)	50.7 (0.5)
	Solubility (mg/l)						
0.0	16.09	13.14	11.69	10.21	8.74	8.74	7.27
5.0	14.06	11.48	10.20	8.91	7.62	7.62	6.34
10.0	12.43	10.15	9.00	7.86	6.71	6.71	5.58
15.0	11.10	9.05	8.03	7.01	5.98	5.98	4.96
20.0	10.02	8.14	7.23	6.30	5.37	5.37	4.44
25.0	9.12	7.40	6.56	5.70	4.84	4.84	4.00
30.0	8.35	6.76	5.99	5.19	4.60	4.60	3.62
35.0	7.69	6.22	5.47	4.75	4.01	4.01	3.28
40.0	7.10	5.72	5.03	4.34	3.65	3.65	2.96

ISO 5814:1990(E)

\*1: Units at standard barometric pressure (normal atmospheric pressure at sea level): 101.325 kPa = 101.325 kN/m<sup>2</sup> = 1 atm = 760 mmHg

**Table 3 Variation of atmospheric pressure with respect to altitude**

Altitude (m)	Mean atmospheric pressure (kPa)
0	101.3
100	100.1
200	98.8
300	97.6
400	96.4
500	95.2
600	94.0
700	92.8
800	91.7
900	90.5
1000	89.4
1100	88.3
1200	87.2
1300	86.1
1400	85.0
1500	84.0
1600	82.9
1700	81.9
1800	80.9
1900	79.9
2000	78.9
2100	77.9

ISO 5814:1990(E)

## ■ Changing the settings

If any setting is accidentally changed, values to the right of the relevant arrow in Table 4 are all initialized.

**Table 4 Parameters that initialize other values**

Sensor type ->	Sensor sensitivity
	Calibration settings: Limits and timing: Zero, Slope (low, high)
Output: Process parameter ->	Linear: 0% value, 100% value
	Table
	Communication: HART: PV
Trend Graph Screen ->	Y-axis (low, high)
	Communication: HART
Configure sensor: Unit ->	Trend: Y-axis: Limits: Oxygen (low, high)

# Appendix 5 Control Drawings

## App. 5.1 ATEX and IECEx

### FLXA202/FLXA21: Intrinsic safety “ia”

Model: FLXA21 /FLXA202

Date: February 19, 2010

11 Drawings

11.1 Control Drawing (for 4–20mA Type)

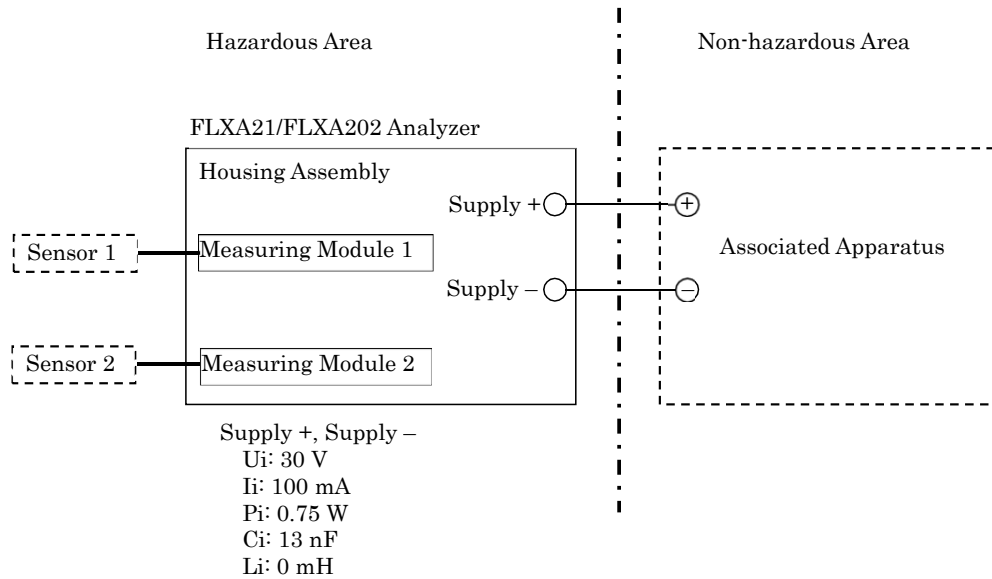

Measuring Module 1, 2

	Type of Measuring Module		
	pH, SC, DO	ISC	SENCOM
Uo	11.76 V	11.76 V	5.36 V
Io	116.5 mA	60.6 mA	106.16 mA
Po	0.3424 W	0.178 W	0.1423 W
Co	100 nF	100 nF	31 μF
Lo	1.7 mH	8 mH	0.45 mH

App.

PH

SC

ISC

DO

SENCOM

Rev.4: July. 25, 2016

Doc. No.: IKE039-A12 P.1

Yokogawa Electric Corporation

Model: FLXA21 /FLXA202

Date: Mar 24, 2013

## Specific Conditions of Use

- When the enclosure of the Analyzer is made of aluminum alloy (FLXA202), and when the Analyzer used in an explosive atmosphere requiring equipment of Category 1 G or EPL Ga, it must be installed in such a way that, even in the event of rare incidents, an ignition source due to impact friction sparks is excluded.
  
- When accessing the display window or other non-metallic parts of the enclosure of FLXA202/FLXA21, take following measures to minimize the risk of explosion from electrostatic discharge.  
Also, avoid any actions that cause the generation of electrostatic charge, such as rubbing with a dry cloth.

To avoid electrostatic charge on the operator,

- Earth the operator through a wrist-strap, or
- Operate FLXA202/FLXA21 on the conductive floors, wearing anti-static work clothes and electrostatic safety shoes, or
- Neutralize the operator and FLXA202/FLXA21 by a static elimination bar which has a metal part earthed through resistor from 100k $\Omega$  to 100M $\Omega$ .

In case that those measures cannot be taken or static electricity cannot be suppressed, bring a gas detector and make sure there is no ignition capable atmosphere around FLXA202/FLXA21 before the operation.

## Notes:

1. The associated apparatus must be a linear source.
2. Measuring Module 2 is not necessarily installed. As for ISC module and SENCOM module, only one module is permitted to be installed at a time.
3. Sensor 1 and Sensor 2 may be simple apparatus or intrinsically safe apparatus.
4. WARNING – POTENTIAL ELECTROSTATIC CHARGING HAZARD – SEE USER'S MANUAL

Rev.2: July. 25, 2016

Doc. No.: IKE039-A12 P.1-1

Yokogawa Electric Corporation

# App. 5.2 CSA

## FLXA202/FLXA21:

### Intrinsic safety, Nonincendive, FLXA202: Type of protection 'n'

Model: FLXA21 / FLXA202

Date: May 29, 2017

Control drawing (4-20mA type)

Installation for Zone 0, 1 / Division 1

Applicable models: FLXA21-D-x-x-CD-xx-xx-A-..., FLXA202-D-x-x-CD-xx-xx-A-...

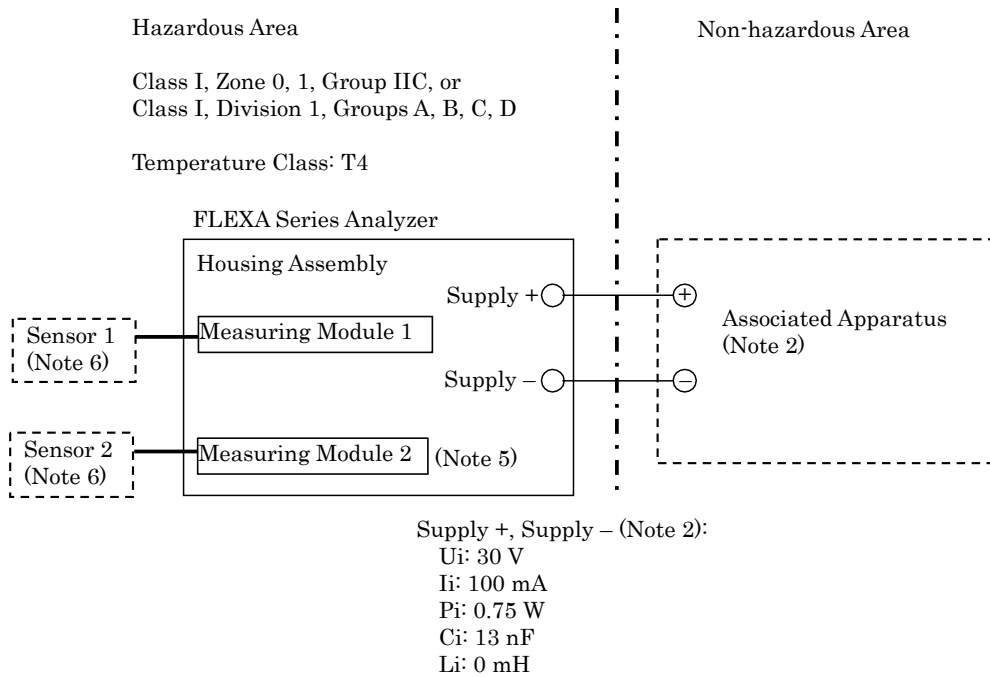

Measuring Module 1, 2 (Note 6):

	Type of Measuring Module		
	pH, SC, DO	ISC	SENCOM
U <sub>o</sub>	11.76 V	11.76 V	5.36 V
I <sub>o</sub>	116.5 mA	60.6 mA	106.16 mA
P <sub>o</sub>	0.3424 W	0.178 W	0.1423 W
C <sub>o</sub>	100 nF	100 nF	31 μF
L <sub>o</sub>	1.7 mH	8 mH	0.45 mH

Specific conditions of use

- Electrostatic charges on the non-metallic or coated parts of the two wire analyzer shall be avoided.
- In the case where the enclosure of the analyzer is made of Aluminum, if it is mounted in Zone 0, it must be installed such, that even in the event of rare incidents, ignition sources due to impact and friction sparks are excluded.

Rev.

Doc. No.: ICS032-A71 P.1

Yokogawa Electric Corporation

App.

PH

SC

ISC

DO

SENCOM



Model: FLXA21 / FLXA202

Date: May 29, 2017

Installation for Zone 2 / Division 2

Applicable models: FLXA21-D-x-x-CD-xx-xx-A-...; FLXA21-D-x-x-DD-xx-xx-A-...;  
 FLXA202-D-x-x-CD-xx-xx-A-...; FLXA202-D-x-x-DD-xx-xx-A-...  
 FLXA202-D-x-x-DE-xx-xx-A-...

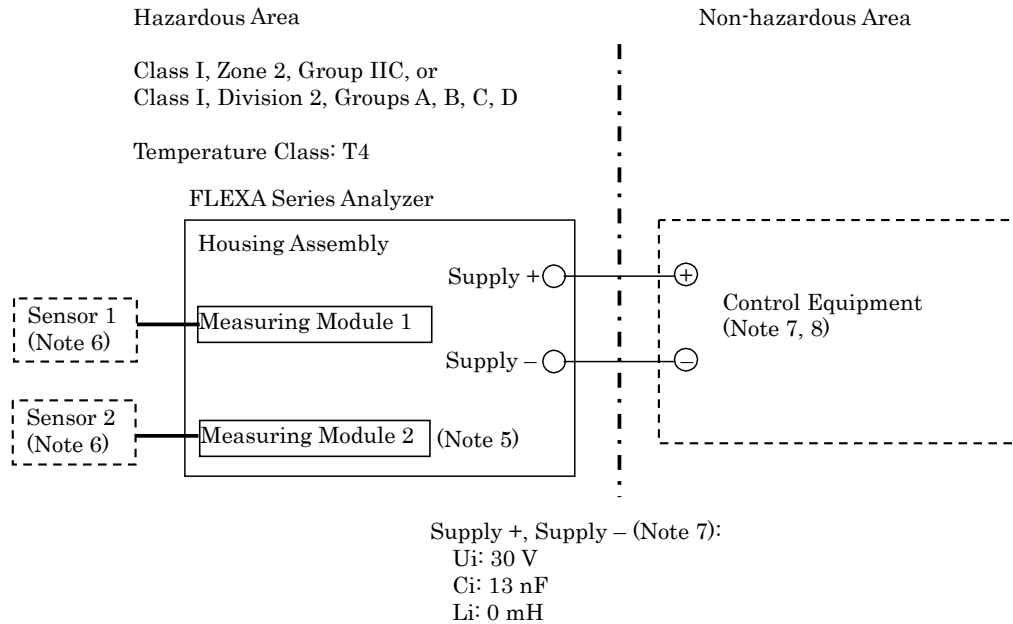

Measuring Module 1, 2 (Note 6):

	Type of Measuring Module		
	pH, SC, DO	ISC	SENCOM
Uo	11.76 V	11.76 V	5.36 V
Io	116.5 mA	60.6 mA	106.16 mA
Po	0.3424 W	0.178 W	0.1423 W
Co	100 nF	100 nF	31 μF
Lo	1.7 mH	8 mH	0.45 mH

Specific condition of use

- Electrostatic charges on the non-metallic or coated parts of the two wire analyzer shall be avoided.

Specific conditions of use for FLXA202-D-x-x-DE-xx-xx-A-... when it is used as “Ex nA ic”

- The cable glands accompanying the equipment may not provide sufficient clamping. Additional clamping of the cable shall be provided to ensure that pulling and twisting are not transmitted to the termination. Alternatively, Ex d, Ex e, or Ex n cable glands which provide sufficient clamping shall be used instead of the accompanying cable gland.
- The gaskets of the cable glands shall be protected from light.
- Analyzer must be installed in such a way that the air vent is physically protected from any possible impact.

Rev.

Doc. No.: ICS032-A71 P.2

Yokogawa Electric Corporation

Model: FLXA21 / FLXA202

Date: May 29, 2017

## Notes:

1. Installation must be in accordance with the Canadian Electric Code Part I (C22.1), ANSI/ISA-RP12.06.01 and relevant local codes.
2. The associated apparatus must be a linear source meeting the following conditions.

$$\begin{aligned}U_o \text{ (or } V_{oc}) &\leq U_i \\I_o \text{ (or } I_{sc}) &\leq I_i \\P_o &\leq P_i \\C_o \text{ (or } C_a) &\geq C_i + C_{cable} \\L_o \text{ (or } L_a) &\geq L_i + L_{cable}\end{aligned}$$

3. Control equipment connected to the associated apparatus must not use or generate a voltage which exceeds  $U_m$  of the associated apparatus.
4. The control drawing of the associated apparatus must be followed when installing the equipment.
5. Measuring Module 2 is not always installed. As for ISC module and SENCOM module, only one module is permitted to be installed at a time.
6. When installed in Zone 0 or 1, or Division 1, Sensor 1 and Sensor 2 may be simple apparatus or intrinsically safe apparatus meeting the conditions below. When installed in Zone 2 or Division 2, Sensor 1 and Sensor 2 may be simple apparatus or non-incendive field wiring apparatus meeting the conditions below, or alternatively, they may be equipment suitable for Zone 2 or Division 2 respectively, if a suitable wiring method other than non-incendive field wiring is employed.

$$\begin{aligned}U_i \text{ (or } V_{max}) &\geq U_o \\I_i \text{ (or } I_{max}) &\geq I_o \\P_i &\geq P_o \\C_i &\leq C_o - C_{cable} \\L_i &\leq L_o - L_{cable}\end{aligned}$$

7. The control equipment must be an associated non-incendive field wiring apparatus meeting the conditions below. Alternatively, it may be general-purpose equipment, if a suitable wiring method other than non-incendive field wiring is employed.

$$\begin{aligned}U_o \text{ (or } V_{oc}) &\leq U_i \\C_o \text{ (or } C_a) &\geq C_i + C_{cable} \\L_o \text{ (or } L_a) &\geq L_i + L_{cable}\end{aligned}$$

8. When FLXA202-D-x-x-DE-xx-xx-A... is used as "Ex nA ic", it must be installed in accordance with one of the following:
  - a) in a SELV or PELV system, or
  - b) via a safety isolating transformer complying with the requirements of IEC 61558-2-6, or a technically equivalent standard, or
  - c) directly connected to apparatus complying with IEC60950 series, IEC61010-1, or a technically equivalent standard, or
  - d) fed directly from cells or batteries.
9. When FLXA202-D-x-x-DE-xx-xx-A... is used as "Ex nA ic" and with the accompanying cable glands, cable with an external diameter of 6 to 12 mm must be used for field wiring. The cable glands must be secured with a tightening torque of 6 Nm so that they can be released only with the aid of a tool. Unused cable gland shall be sealed with the accompanying metal plug.

Rev.

Doc. No.: ICS032-A71 P.3

Yokogawa Electric Corporation

App.

PH

SC

ISC

DO

SENCOM

Model: FLXA21 / FLXA202

Date: May 29, 2017

10. WARNING – POTENTIAL ELECTROSTATIC CHARGING HAZARD  
AVERTISSEMENT – DANGER POTENTIEL DE CHARGES ÉLECTROSTATIQUES
11. WARNING – SUBSTITUTION OF COMPONENTS MAY IMPAIR INTRINSIC SAFETY  
AVERTISSEMENT – LA SUBSTITUTION DE COMPOSANTS PEUT COMPROMETTRE LA  
SÉCURITÉ INTRINSÈQUE.
12. WARNING – SUBSTITUTION OF COMPONENTS MAY IMPAIR SUITABILITY FOR  
ZONE 2 / DIVISION 2  
AVERTISSEMENT – LA SUBSTITUTION DE COMPOSANTS PEUT RENDRE CE MATÉRIEL  
INACCEPTABLE POUR LES EMPLACEMENTS DE ZONE 2 / DIVISION 2

Rev.

Doc. No.: ICS032-A71 P.4

Yokogawa Electric Corporation

# App. 5.3 FM

## FLXA202/FLXA21:

### Intrinsic safety, Nonincendive

Model: FLEXA Series

Date: April 17, 2015

Control drawing (4–20 mA type)

Installation for Division 1 / Zone 0, 1

Applicable models: FLXA21-D-x-x-CD-xx-xx-A-..., FLXA202-D-x-x-CD-xx-xx-A-...

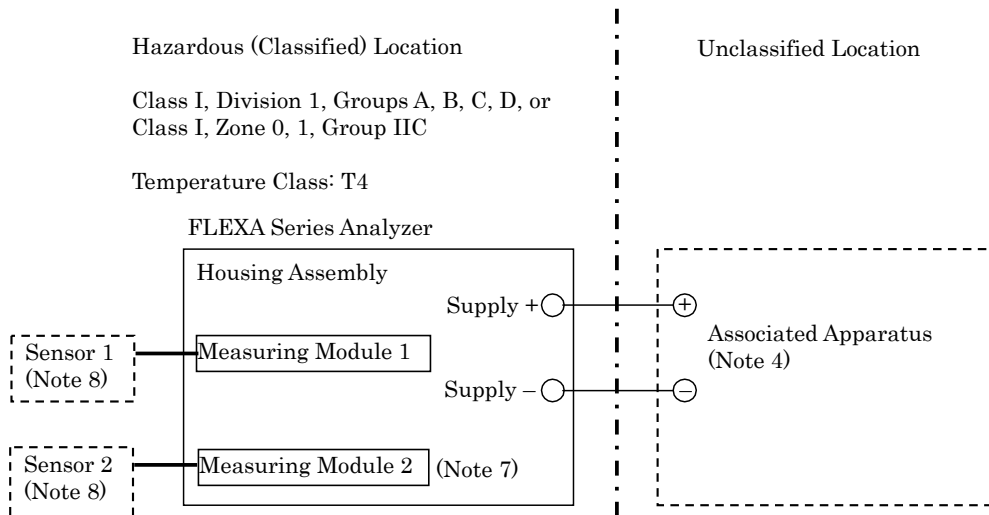

Supply +, Supply – (Note 4):

- Ui: 30 V
- Ii: 100 mA
- Pi: 0.75 W
- Ci: 13 nF
- Li: 0 mH

Measuring Module 1, 2 (Note 8):

	Type of Measuring Module		
	pH, SC, DO	ISC	SENCOM
Uo	11.76 V	11.76 V	5.36 V
Io	116.5 mA	60.6 mA	106.16 mA
Po	0.3424 W	0.178 W	0.1423 W
Co	100 nF	100 nF	31 µF
Lo	1.7 mH	8 mH	0.45 mH

Specific conditions of use:

- Electrostatic charges on the non-metallic or coated parts of the two wire analyzer shall be avoided.
- In the case where the enclosure of the analyzer is made of Aluminum, if it is mounted in ZONE 0, it must be installed such that, even in the event of rare incidents, ignition sources due to impact and friction sparks are excluded.

Rev.1: May 29, 2017

Doc. No.: IFM039-A71 P.1

Yokogawa Electric Corporation

App.

PH

SC

ISC

DO

SENCOM

Model: FLEXA Series

Date: April 17, 2015

Installation for Division 2 / Zone 2

Applicable models: FLXA21-D-x-x-CD-xx-xx-A-..., FLXA21-D-x-x-DD-xx-xx-A-...;  
 FLXA202-D-x-x-CD-xx-xx-A-..., FLXA202-D-x-x-DD-xx-xx-A-...

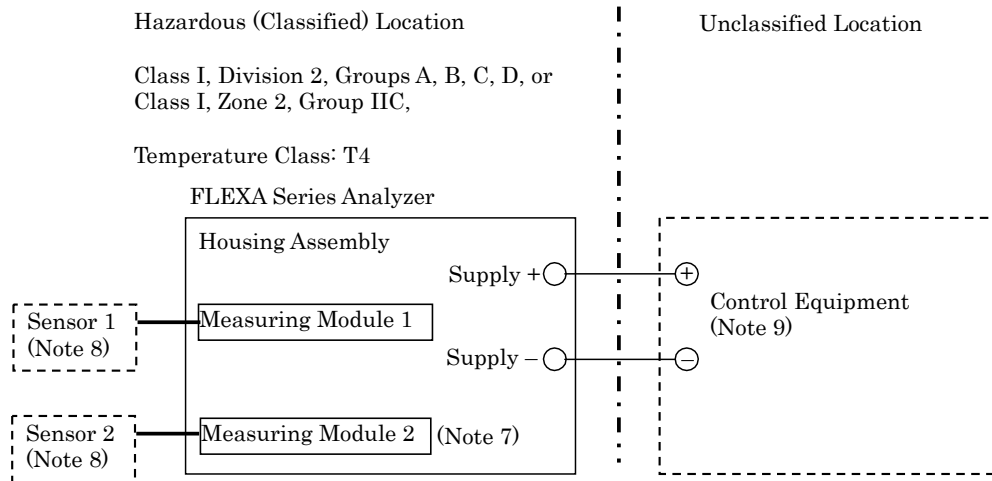

Supply +, Supply - (Note 9):

U: 30 V  
 Ci: 13 nF  
 Li: 0 mH

Measuring Module 1, 2 (Note 8):

	Type of Measuring Module		
	pH, SC, DO	ISC	SENCOM
U <sub>o</sub>	11.76 V	11.76 V	5.36 V
I <sub>o</sub>	116.5 mA	60.6 mA	106.16 mA
P <sub>o</sub>	0.3424 W	0.178 W	0.1423 W
C <sub>o</sub>	100 nF	100 nF	31 μF
L <sub>o</sub>	1.7 mH	8 mH	0.45 mH

Specific condition of use:

- Electrostatic charges on the non-metallic or coated parts of the two wire analyzer shall be avoided.

Rev.1: May 29, 2017

Doc. No.: IFM039-A71 P.2

Yokogawa Electric Corporation

Model: FLEXA Series

Date: May 29, 2017

Notes:

1. This drawing replaces the former control drawing IKE039-A12.
2. No revision to this drawing without prior approval of FM.
3. Installation must be in accordance with the National Electric Code (NFPA 70), ANSI/ISA-RP12.06.01 and relevant local codes.
4. The associated apparatus must be an FM-approved linear source meeting the following conditions.

$$\begin{aligned}
 U_o \text{ (or } V_{oc}) &\leq U_i \\
 I_o \text{ (or } I_{sc}) &\leq I_i \\
 P_o &\leq P_i \\
 C_o \text{ (or } C_a) &\geq C_i + C_{cable} \\
 L_o \text{ (or } L_a) &\geq L_i + L_{cable}
 \end{aligned}$$

5. Control equipment connected to the associated apparatus must not use or generate a voltage which exceeds  $U_m$  of the associated apparatus.
6. The control drawing of the associated apparatus must be followed when installing the equipment.
7. Measuring Module 2 is not always installed. As for ISC module and SENCOM module, only one module is permitted to be installed at a time.
8. When installed in Division 1, Zone 0 or Zone 1, Sensor 1 and Sensor 2 may be simple apparatus or intrinsically safe apparatus meeting the conditions below.  
When installed in Division 2 or Zone 2, Sensor 1 and Sensor 2 may be simple apparatus or nonincendive field wiring apparatus meeting the conditions below, or alternatively, they may be equipment suitable for Division 2 or Zone 2 respectively, if a suitable wiring method other than nonincendive field wiring is employed.

$$\begin{aligned}
 U_i \text{ (or } V_{max}) &\geq U_o \\
 I_i \text{ (or } I_{max}) &\geq I_o \\
 P_i &\geq P_o \\
 C_i &\leq C_o - C_{cable} \\
 L_i &\leq L_o - L_{cable}
 \end{aligned}$$

9. The control equipment must be an FM-approved associated nonincendive field wiring apparatus meeting the conditions below. Alternatively, it may be general-purpose equipment, if a suitable wiring method other than nonincendive filed wiring is employed.

$$\begin{aligned}
 U_o \text{ (or } V_{oc}) &\leq U_i \\
 C_o \text{ (or } C_a) &\geq C_i + C_{cable} \\
 L_o \text{ (or } L_a) &\geq L_i + L_{cable}
 \end{aligned}$$

10. WARNING – POTENTIAL ELECTROSTATIC CHARGING HAZARD – WHEN THE EQUIPMENT IS USED IN HAZARDOUS LOCATIONS, AVOID ANY ACTION WHICH GENERATE ELECTROSTATIC DISCHARGE SUCH AS RUBBING WITH A DRY CLOTH.
11. WARNING – IN THE CASE WHERE THE ENCLOSURE OF THE ANALYZER IS MADE OF ALUMINUM, IF IT IS MOUNTED IN ZONE 0, IT MUST BE INSTALLED SUCH THAT, EVEN IN THE EVENT OF RARE INCIDENTS, IGNITION SOURCES DUE TO IMPACT AND FRICTION SPARKS ARE EXCLUDED
12. WARNING – SUBSTITUTION OF COMPONENTS MAY IMPAIR INTRINSIC SAFETY AND SUITABILITY FOR DIVISION 2 / ZONE 2.

Rev.

Doc. No.: IFM039-A71 P.3

Yokogawa Electric Corporation

App.

PH

SC

ISC

DO

SENCOM

# App. 5.4 ATEX (Type n) FLXA202: Type of protection 'n'

Model: FLXA202

Date: December 25, 2015

Control Drawing

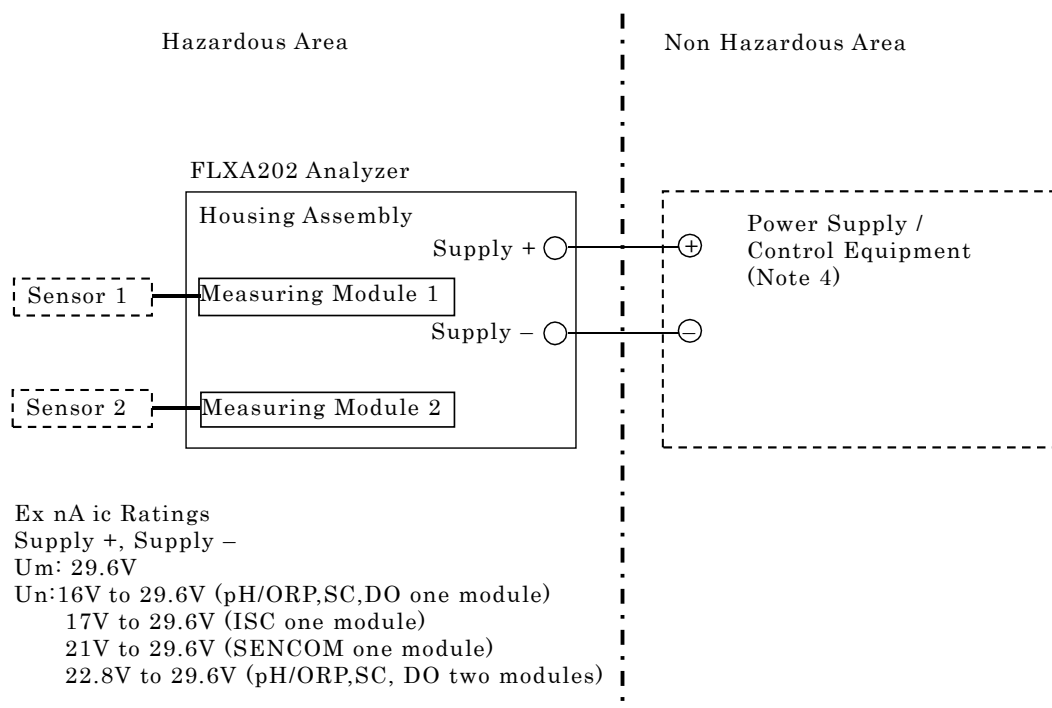

Ex nA ic Ratings  
 Supply +, Supply -  
 Um: 29.6V  
 Un: 16V to 29.6V (pH/ORP,SC,DO one module)  
     17V to 29.6V (ISC one module)  
     21V to 29.6V (SENCOM one module)  
     22.8V to 29.6V (pH/ORP,SC, DO two modules)

Measuring Module 1, 2

	Type of Measuring Module		
	pH, SC, DO	ISC	SENCOM
Uo	11.76 V	11.76 V	5.36 V
Io	116.5 mA	60.6 mA	106.16 mA
Po	0.3424 W	0.178 W	0.1423 W
Co	100 nF	100 nF	31 µF
Lo	1.7 mH	8 mH	0.45 mH

Specific condition of use

- Electrostatic charges on the non-metallic or coated parts of the two wire analyzer shall be avoided.
- The cable gland accompanying the equipment may not provide sufficient clamping. Additional clamping of the cable shall be provided to ensure that pulling and twisting are not transmitted to the termination. Alternatively, an Ex d, Ex e, or Ex n cable gland which provides sufficient clamping shall be used instead of the accompanying cable gland.
- Analyzer must be installed in such a way that the air vent is physically protected from any possible impact.

Rev. 1: July 24, 2017

Doc.No.: NKE053-A71 P.1

Yokogawa Electric Corporation

Model: FLXA202

Date: December 25, 2015

## Notes:

1. Installation must be in accordance with EN60079-14 and relevant local codes.
2. Measuring Module 2 is not always installed. As for ISC module and SENCOM module, only one module is permitted to be installed at a time.
3. When installed in an area where the use of Category 3 G equipment is required, Sensor 1 and Sensor 2 may be simple apparatus, intrinsically safe apparatus meeting conditions below, or other Category 3 G equipment.

$$U_i \text{ (or } V_{\max}) \geq U_o$$

$$I_i \text{ (or } I_{\max}) \geq I_o$$

$$P_i \geq P_o$$

$$C_i \leq C_o - C_{\text{cable}}$$

$$L_i \leq L_o - L_{\text{cable}}$$

4. FLXA202 Analyzer must be installed in accordance with one of the following:
  - a) in a SELV or PELV system, or
  - b) via a safety isolating transformer complying with the requirements of IEC 61558-2-6, or a technically equivalent standard, or
  - c) directly connected to apparatus complying with IEC60950 series, IEC61010-1, or a technically equivalent standard, or
  - d) fed directly from cells or batteries.
5. When FLXA202 Analyzer is installed with accompanying cable glands, cable with an external diameter of 6 mm to 12 mm must be used for field wiring. The cable glands must be secured with a tightening torque of 6 Nm so that they can be released only with the aid of a tool. Unused cable gland shall be sealed with the accompanying metal plug.
6. The gaskets of the cable glands shall be protected from light.

App.

PH

SC

ISC

DO

SENCOM

Rev. 1: July 24, 2017

Doc.No.: NKE053-A71 P.2

Yokogawa Electric Corporation



# App. 5.5 IECEx (Type n)

## FLXA202: Type of protection ‘n’

Model: FLXA202

Date: March 31, 2016

Control Drawing

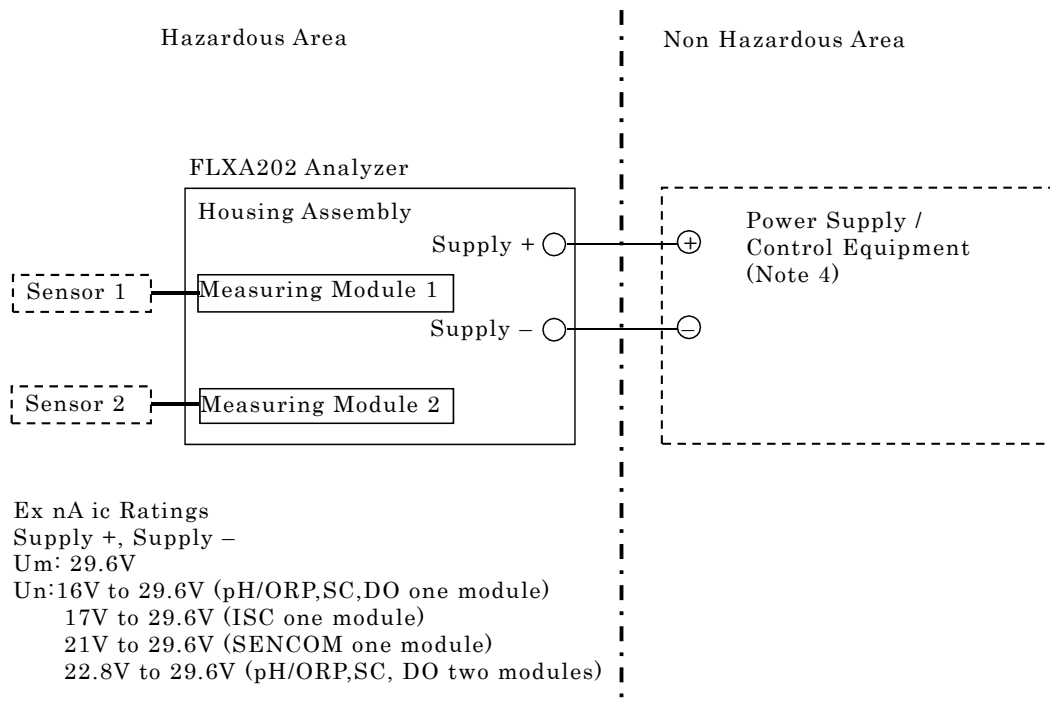

Ex nA ic Ratings  
 Supply +, Supply –  
 Um: 29.6V  
 Un: 16V to 29.6V (pH/ORP,SC,DO one module)  
 17V to 29.6V (ISC one module)  
 21V to 29.6V (SENCOM one module)  
 22.8V to 29.6V (pH/ORP,SC, DO two modules)

Measuring Module 1, 2

	Type of Measuring Module		
	pH, SC, DO	ISC	SENCOM
Uo	11.76 V	11.76 V	5.36 V
Io	116.5 mA	60.6 mA	106.16 mA
Po	0.3424 W	0.178 W	0.1423 W
Co	100 nF	100 nF	31 µF
Lo	1.7 mH	8 mH	0.45 mH

Specific condition of use

- Electrostatic charges on the non-metallic or coated parts of the two wire analyzer shall be avoided.
- The cable gland accompanying the equipment may not provide sufficient clamping. Additional clamping of the cable shall be provided to ensure that pulling and twisting are not transmitted to the termination. Alternatively, an Ex d, Ex e, or Ex n cable gland which provides sufficient clamping shall be used instead of the accompanying cable gland.
- The gaskets of the cable glands shall be protected from light.
- Analyzer must be installed in such a way that the air vent is physically protected from any possible impact.

Rev.

Doc.No.: NIE015-A71 P.1

Yokogawa Electric Corporation

Model: FLXA202

Date: March 31, 2016

## Notes:

1. Installation must be in accordance with IEC60079-14 and relevant local codes.
2. Measuring Module 2 is not always installed. As for ISC module and SENCOM module, only one module is permitted to be installed at a time.
3. When installed in an area where EPL Gc is required, Sensor 1 and Sensor 2 may be simple apparatus, intrinsically safe apparatus meeting conditions below, or other EPL Gc equipment.

$$U_i \text{ (or } V_{\max}) \geq U_o$$

$$I_i \text{ (or } I_{\max}) \geq I_o$$

$$P_i \geq P_o$$

$$C_i \leq C_o - C_{\text{cable}}$$

$$L_i \leq L_o - L_{\text{cable}}$$

4. FLXA202 Analyzer must be installed in accordance with one of the following:
  - a) in a SELV or PELV system, or
  - b) via a safety isolating transformer complying with the requirements of IEC 61558-2-6, or a technically equivalent standard, or
  - c) directly connected to apparatus complying with IEC60950 series, IEC61010-1, or a technically equivalent standard, or
  - d) fed directly from cells or batteries.
5. When FLXA202 Analyzer is installed with accompanying cable glands, cable with an external diameter of 6 mm to 12 mm must be used for field wiring. The cable glands must be secured with a tightening torque of 6 Nm so that they can be released only with the aid of a tool. Unused cable gland shall be sealed with the accompanying metal plug.

App.

PH

SC

ISC

DO

SENCOM

Rev.

Doc.No.: NIE015-A71 P.2

Yokogawa Electric Corporation

## App. 5.6 NEPSI and KOSHA

### FLXA202/FLXA21: Intrinsic safety “ia”

(Refer to App. 5.1 ATEX and IECEx Control Drawing)

# Customer Maintenance Parts List

## FLXA21 2-Wire Analyzer

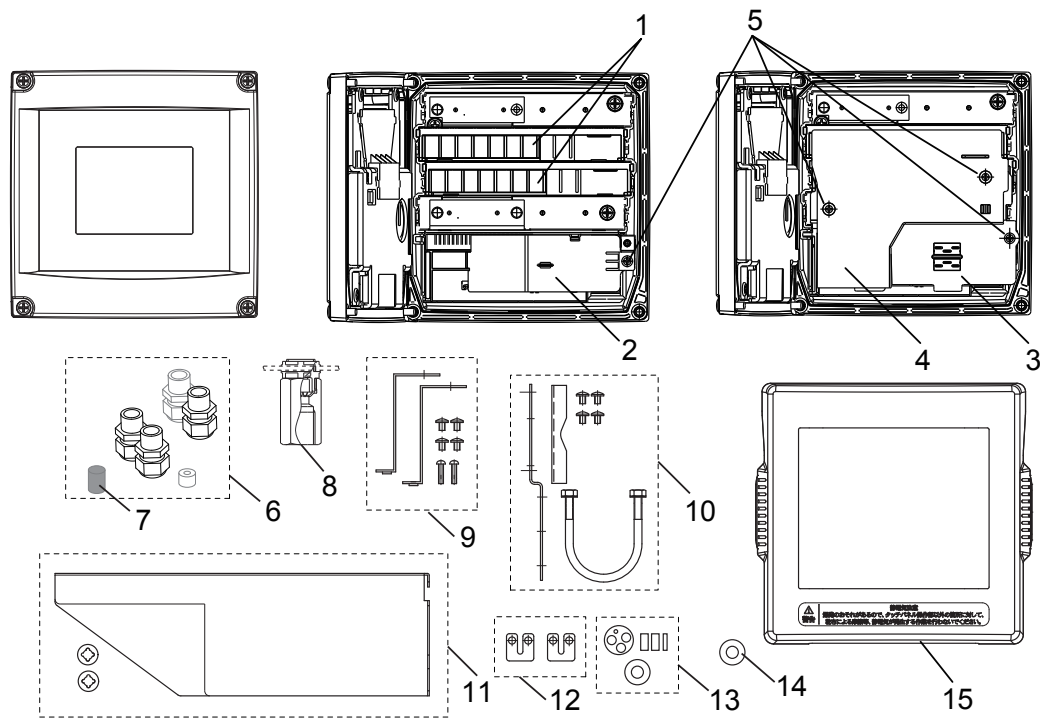

Item	Part No.	Qty	Description
1	—	—	Sensor module assembly, QIC sheet is included.
	(see Table 1)	1	pH/ORP Sensor module assembly, 12(Jumper) and 13(Grommet set) are included.)
	(see Table 1)	1	SC Sensor module assembly
	(see Table 1)	1	ISC Sensor module assembly
	(see Table 1)	1	DO Sensor module assembly
	(see Table 1)	1	SENCOM Sensor module assembly (14(Grommet) is included.)
2	—	1	Shield plate
3	—	1	Shield assembly
4	—	1	Shield plate
5	Y9304LU	4	Screw
6	—	—	Cable gland assembly
	K9698WF	1	For plastic housing (1 sensor) (cable gland x3, sleeve x1)
	K9698WA	1	For plastic housing (2 sensors) (cable gland x4, sleeve x1)
	K9698ZL	1	For stainless steel housing (cable gland x3, close up plug (rubber plug) x1)
7	K9334CN	1	Rubber plug (for auxiliary component)
8	—	—	Conduit adapter set
	K9698WC	1	G1/2 x 4pcs (option code: /CB4)
	K9698WD	1	1/2NPT x 4pcs (option code: /CD4)
	K9698WE	1	M20x1.5 x 4pcs (option code: /CF4)
9	K9698ZD	1	Panel mounting set (option code: /PM)
10	K9171SS	1	Pipe and wall mounting set (option code: /U)
11	—	—	Hood assembly
	K9698WK	1	Stainless steel (option code: /H6)
	K9698WL	1	Stainless steel + urethane coating (option code: /H7)
	K9698WH	1	Stainless steel + epoxy coating (option code: /H8)
12	A1525JT	2	Jumper (only for pH)
13	K9676BY	1	Grommet set (only for pH)
14	K9676CL	1	Grommet (only for SENCOM)
15	K9698NF	1	Protection cover (only for THIS)

**Table 1** Item 1; Sensor module assembly, QIC sheet is included.

Type code Module	-EA, -EF (Intrinsic safety) *1	-EG, -EQ, -ER (Intrinsic safety) *1	-AA (General purpose) *2	-AQ, -AR (General purpose) *2	-ES (General purpose and Intrinsic safety) *1, *2	-CB, -CD, -CH (Intrinsic safety) *1	-AB, -AD, -AG, -DD (General purpose and nonincentive) *1, *2
pH/ORP	K9698ES		K9698ER		—	K9702ES	K9702ER
SC	K9698FS		K9698FR		—	K9702FS	K9702FR
ISC	K9698GS		K9698GR		—	K9702GS	K9702GR
DO	K9698HS		K9698HR		—	K9702HS	K9702HR
SENCOM	—	K9698JS	K9698JS	—	K9698JS	K9702JS	

\*1: If you like to replace sensor modules complied with intrinsic safety, Type-n , or nonincentive type for maintenance, please consult us.

\*2: Module for general purpose use may not be used as intrinsic safety type.

Note: The part numbers in Table 1 are modules with QIC. Sensor module number in the Table 2 shows each number printed on the corresponding sensor module. However, you can not order with the sensor module number in Table 2.

**Table 2** Sensor module number (reference)

Sensor module assembly	Sensor module number	Sensor module assembly	Sensor module number
<b>K9698ES</b>	K9698EA	<b>K9702ES</b>	K9702EA
<b>K9698FS</b>	K9698FA	<b>K9702FS</b>	K9702FA
<b>K9698GS</b>	K9698GA	<b>K9702GS</b>	K9702GA
<b>K9698HS</b>	K9698HA	<b>K9702HS</b>	K9702HA
<b>K9698JS</b>	K9698JA	<b>K9702JS</b>	K9702JA
<b>K9698ER</b>	K9698ED	<b>K9702ER</b>	K9702ED
<b>K9698FR</b>	K9698FD	<b>K9702FR</b>	K9702FD
<b>K9698GR</b>	K9698GD	<b>K9702GR</b>	K9702GD
<b>K9698HR</b>	K9698HD	<b>K9702HR</b>	K9702HD

# Customer Maintenance Parts List

## FLXA202 2-Wire Analyzer

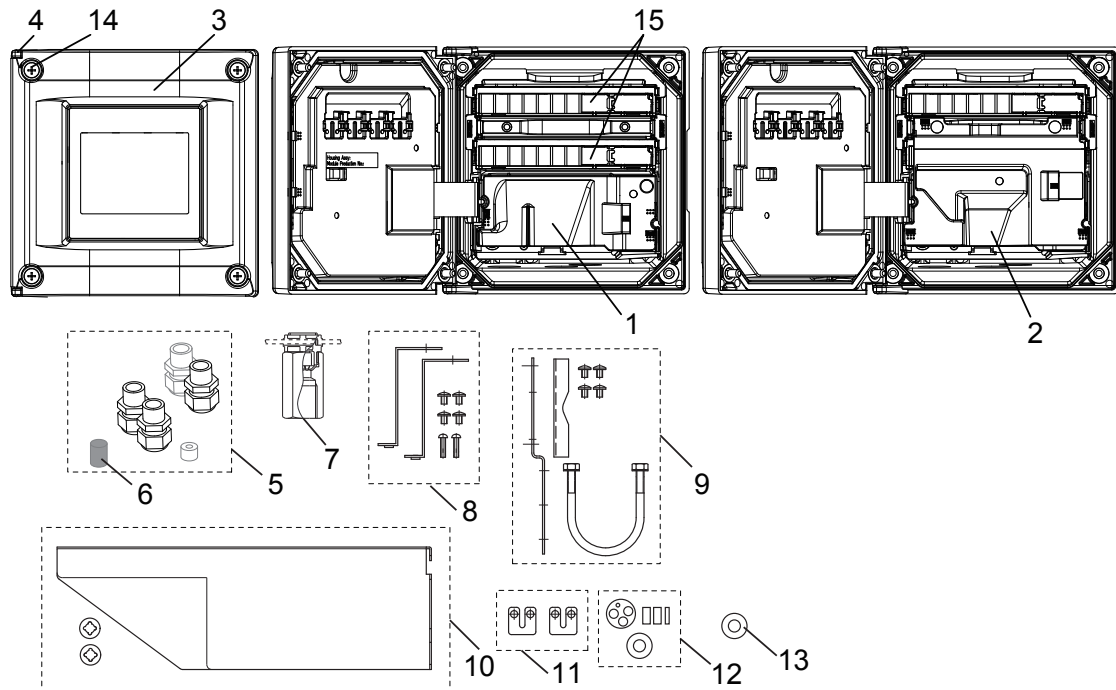

Item	Part No.	Qty	Description
1	K9699MD	1	Shield plate
2	K9699ME	1	Shield plate
3	—	—	Cover assembly
	K9699QK	1	urethane coating
	K9699QL	1	epoxy coating
	K9699QM	1	high anti-corrosion coating
4	K9699PP	1	Hinge pin assembly (Hinge pin + spring)
5	—	—	Cable gland assembly
	K9699ZN	1	For Type n (metal cable gland x3, close up plug (rubber plug) x1)
	K9699ZM	1	Except Type n (plastic cable gland x3, close up plug (rubber plug) x1)
6	K9334CN	1	Rubber plug (for auxiliary component)
7	—	—	Conduit adapter set
	K9699WF	1	G1/2 x 3pcs (option code: /CB4)
	K9699WG	1	1/2NPT x 3pcs (option code: /CD4)
	K9699WH	1	M20x1.5 x 3pcs (option code: /CF4)
8	K9698ZD	1	Panel mounting set (option code: /PM)
9	K9171SS	1	Pipe and wall mounting set (option code: /U)
10	—	—	Hood assembly
	K9698WK	1	Stainless steel (option code: /H6)
	K9698WL	1	Stainless steel + urethane coating (option code: /H7)
	K9698WH	1	Stainless steel + epoxy coating (option code: /H8)
11	A1525JT	2	Jumper (only for pH)
12	K9676BY	1	Grommet set (only for pH)
13	K9676CL	1	Grommet (only for SENCOM)
14	K9699PL	5	Screw assembly (M5 screw + spring)
15	—	—	Sensor module assembly, QIC sheet is included.
	(see Table 1)		pH/ORP Sensor module assembly (12(Jumper) and 13(Grommet set) are included.)
	(see Table 1)		SC Sensor module assembly
	(see Table 1)		ISC Sensor module assembly
	(see Table 1)		DO Sensor module assembly
	(see Table 1)		SENCOM Sensor module assembly (14(Grommet) is included.)

**Table 1 Item 1; Sensor module assembly, QIC sheet is included.**

Type code Module	-CB, -CD, -CF, -CG, -CH, -CQ, -CR (Intrinsic safety) *1	-AB, -AD, -AG, -AQ, -AR, -DB, -DD, -DE (General purpose, nonincentive and Type-n) *1, *2
pH/ORP	K9702ES	K9702ER
SC	K9702FS	K9702FR
ISC	K9702GS	K9702GR
DO	K9702HS	K9702HR
<b>SENCOM</b>	K9702JS	

\*1: If you like to replace sensor modules complied with intrinsic safety, Type-n , or nonincentive type for maintenance, please consult us.

\*2: Module for general purpose use may not be used as intrinsic safety type.

Note: The part numbers in Table 1 are modules with QIC. Sensor module number in the Table 2 shows each number printed on the corresponding sensor module. However, you can not order with the sensor module number in Table 2.

**Table 2 Sensor module number (reference)**

Sensor module assembly	Sensor module number	Sensor module assembly	Sensor module number
<b>K9702ES</b>	K9702EA	<b>K9702ER</b>	K9702ED
<b>K9702FS</b>	K9702FA	<b>K9702FR</b>	K9702FD
<b>K9702GS</b>	K9702GA	<b>K9702GR</b>	K9702GD
<b>K9702HS</b>	K9702HA	<b>K9702HR</b>	K9702HD
<b>K9702JS</b>	K9702JA		

# Revision Record

- Manual Title : Model FLXA202 / FLXA21 2-Wire Analyzer
- Manual No. : IM 12A01A02-01E

## Mar. 2018/9th Edition

Overall review.

Change and addition of the mark position (P. v, vi, 1-4)

Regulatory Compliance (P.1-11)

Explosion Protected Type Compliance (P.1-12, 1-13, 2-4, 2-5, 2-9)

Addition of Model & Suffic Codes (P.1-16 to 1-19)

Addition of Control Drawings (Appendix 5)

Correction (P. i, ii, viii, ix, 1-3, 1-5, 2-2, 2-6 to 2-8, 2-11 to 2-14, 2-20, 4-15, 7-3, 7-9, 7-12, 10-10, 13-10, 16-15, App.1-4, App.2-3, App.2-4, App.2-8, App.3-3, App.3-7, CMPL 12A01A02-01E, CMPL 12A01A03-01EN)

HOUSING ASSY Software Revision 2.13

## Oct. 2015/8th Edition

Addition of FLXA202

FLXA202 Product Career S1

FLXA21 Product Career S3

## Apr. 2015/7th Edition

HOUSING ASSY Software Revision 2.11

Software revision (P. 3-3, 6-3, 12-3, 12-4, 12-7, 16-2 to 16-4)

User's Manual for FOUNDATION Fieldbus or PROFIBUS PA Communication (P.i)

Regulatory Compliance (P.1-9)

Note for wall mounting (P.2-14)

Change of "type of ground" of the stainless steel housing (P.2-1, 2-3, 2-5, 2-6)

Correction (P.App.2-8, App3-8)

## Oct. 2014/6th Edition

Addition of NEPSI and ATEX/IECEX (SENCOM module).

## Oct. 2013/5th Edition

HOUSING ASSY Software Revision 2.10

Addition of MONITOR display, and other corrections

## Sep. 2013/4th Edition

Product Career S2, HOUSING ASSY Software Revision 2.02

Addition of SENCOM pH/ORP sensor

Deletion of section of General Specification

Change of safety symbols and words

Addition of FM and CSA intrinsically safe approval

Change of number of cable entries on stainless steel housing; Change of parts of cable glands and change of sealing

Change of display message for malfunction and warning

Change of menu trees

Addition of check method for ORP sensor electrode

Addition of detail data of temperature compensation matrixes

Separation of appendix of HART Communication (This appendix is issued as Technical Information, TI 12A01A02-60E.)

And, other minor changes and corrections

## Feb. 2012/3rd Edition

Change of numbers of chapters (composition of manual)

Addition of descriptions and drawings for intrinsically safe type

Change of descriptions of messages on displays

Change of figures of housing due to change of position of external grounding for stainless steel housing

Change of figures of wiring covers



---

Change of description of message language due to addition of message languages  
Addition of CAUTIONs for replacement of modules for intrinsically safe type  
And, other corrections

**Aug. 2010/2nd Edition**

- p. i Addition of “■ Composition of this User’s Manual”
- Section 1.3 Addition of WARNING, explanation, and examples of displays of calculated data and redundant system
- Section 1.4 Addition of “Passwords”
- Section 2 Addition of specification of wire terminal, and style code of PH201G
- Section 3 Revision and addition of drawings and explanation of stainless steel housing due to change of design (grounding terminal and plate)  
Addition of sleeve for grounding cable line of plastic housing  
Correction of torque value  
Addition of DANGER, WARNING and CAUTION  
Addition of explanation of wire terminal  
Addition of drawing of hood
- Section 6, 11, 14, and 17  
Addition of CAUTION, and example of display of calibration
- Section 8 Addition of “■ Installation of sensor module”
- Section 10.7 Correction and addition of calculated data
- Appendix 2 Addition of “■ Monitoring of Purified Water and WFI according to USP<645>”
- Appendix 4 Correction of error  
Addition of CAUTION, “■ Operational Precaution”, and “■ Note for Functions”

\*\* Above are main revisions.

**May 2010/1st Edition**

Newly published

---

Yokogawa Electric Corporation  
2-9-32 Nakacho, Musashino-shi, Tokyo 180-8750, JAPAN  
Homepage: <http://www.yokogawa.com/>

---

Thank you for selecting our FLXA202/FLXA21 2-Wire Analyzer.

The following addition has been made on User's Manual, IM 12A01A02-01E 9th Edition.

Please read carefully before using the FLXA202/FLXA21.

Note

### ◆ Tightening torque has changed. (P. 2-10 “2.5 Sensor Wiring”)

On the first “CAUTION” of P. 2-11.

#### CAUTION

---

Do not tighten up four front panel screws one by one.

Each front panel screw should be tightened up in two times of screwing. And, firstly the screw at the upper left should be screwed a bit, the next is at the lower right, third is at the upper right, and fourth is at the lower left. The second round is the same sequence again to tighten up four screws.

Do not use an electric screwdriver with high revolutions. If an electric screwdriver is used for these front panel screws, the revolutions of the electric screwdriver should be less than 400 rpm.

Four screws should be tightened to the following torque; **1.5 to 1.6 N·m**

---

### ◆ Addition of NOTE (P. 16-3 “16.1 Sensor setup”)

The following NOTE has been added.

#### NOTE

---

The sensor setup configured here is stored in FU20F pH/ORP SENCOM Sensor as well.

When FU20F is used with FLXA202/FLXA21 or SPS24 (SENCOM PC software) and the sensor setup saved in these instruments does not match with FU20F's one, a prompt appears to tell the sensor setup is not matched.

Be sure to share the same sensor setup between FU20F and FLXA202/FLXA21 or SPS24.

---

### ◆ Addition of statement (P. 19-1 “19. TROUBLESHOOTING”)

The following statement has been added.

#### ■ Error for failed communication when used with FU20F

When you boot FLXA202/FLXA21 with FU20F, Checksum Error or communication error may be displayed. Check the connection between FU20F sensor to the cable, and the cable to FLXA202/FLXA21. Reboot FLXA202/FLXA21 by turning power off/on.

## ◆ Appendix 5 Control Drawings has changed.

### (P. App.5-7 “App. 5.3 FM FLXA202/FLXA21: Intrinsic safety, Nonincendive”)

Control drawing (4-20mA type) of Installation for Division 2/ Zone 2 on P. App.5-8 has been replaced with the following.

Model: FLEXA Series

Date: April 17, 2015

#### Installation for Division 2 / Zone 2

Applicable models: FLXA21-D-x-x-CD-xx-xx-A-..., FLXA21-D-x-x-DD-xx-xx-A-...;  
FLXA202-D-x-x-CD-xx-xx-A-..., FLXA202-D-x-x-DD-xx-xx-A-...

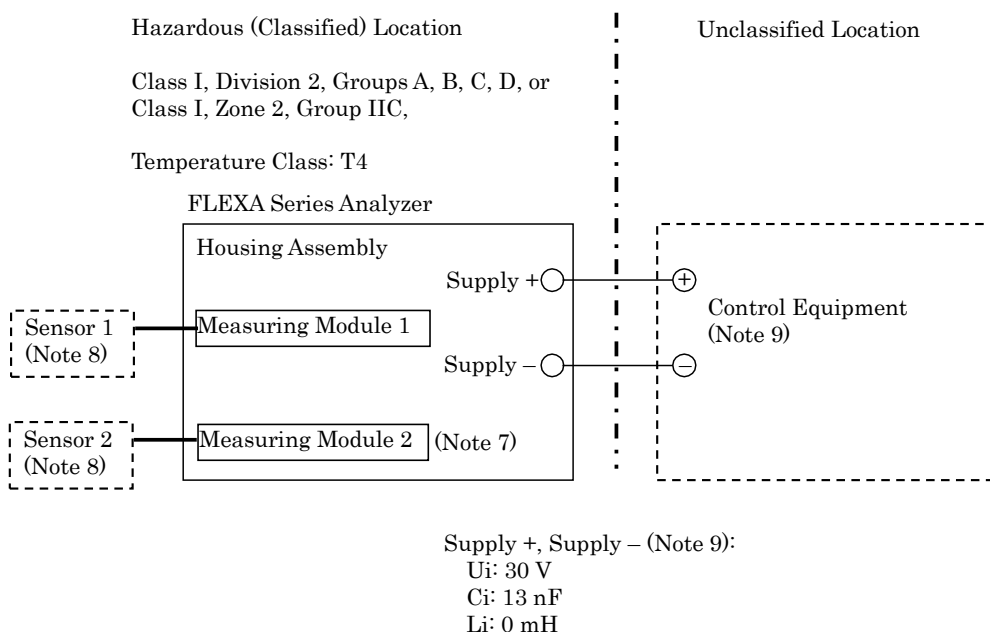

Measuring Module 1, 2 (Note 8):

	Type of Measuring Module		
	pH, SC, DO	ISC	SENCOM
Uo	11.76 V	11.76 V	5.36 V
Io	116.5 mA	60.6 mA	106.16 mA
Po	0.3424 W	0.178 W	0.1423 W
Co	4 $\mu$ F	4 $\mu$ F	31 $\mu$ F
Lo	4.5 mH	19 mH	0.45 mH

Specific condition of use:

- Electrostatic charges on the non-metallic or coated parts of the two wire analyzer shall be avoided.

Rev.2: Sep. 15, 2017

Doc. No.: IFM039-A71 P.2

Yokogawa Electric Corporation