

Aztec AWT440

Multi-input transmitter



Measurement made easy

Aztec AWT440 multi-input transmitter

Introduction

The Aztec AWT440 is a universal multi-input transmitter that uses ABB's Aztec 400 range of advanced digital sensors for monitoring the key parameters in municipal and industrial water / wastewater treatment.

The transmitter has multiple sensor capability that enables it to control and display information from up to 4 sensors.

This communications supplement provides Profibus®, MODBUS® and Ethernet connection / configuration details together with Profibus and MODBUS reference tables for the Aztec AWT440 transmitter.

For more information

Further publications are available for free download from:

www.abb.com/measurement

or by scanning this code:



Search for or click on

Aztec 440
Data Sheet

[DS/AWT440-EN](#)

Aztec AWT440 transmitter –
Commissioning Instruction

[CI/AWT440-EN](#)

Aztec AWT440 transmitter –
Operating Instruction

[OI/AWT440-EN](#)

Contents

1 Health & Safety	4	A.3.1 Slot 1 – Alarm Acknowledge	23
1.1 Document symbols	4	A.3.2 Slot 2 – Calibration Clear	23
1.2 Safety precautions	4	A.4 Read-only float	24
1.3 Potential safety hazards	4	A.4.1 Slot 3 – measured values and ranges	24
1.3.1 Aztec AWT440 transmitter – electrical	4	A.5 Device Info	26
1.4 Safety standards	4	A.5.1 Slot 4	26
1.5 Product symbols	5	A.6 Device Info	26
1.6 Product recycling and disposal (Europe only)	5	A.6.1 Slot 5	26
1.6.1 End-of-life battery disposal	5	A.7 Device Info	26
1.7 Restriction of Hazardous Substances (RoHS)	5	A.7.1 Slot 6	26
2 Communications overview	6	A.8 Device Info	27
2.1 Cyber security	6	A.8.1 Slot 7	27
2.2 Ethernet	6	A.9 Configuration	28
2.3 RS485 MODBUS	6	A.9.1 Slot 8	28
2.4 Profibus	6	A.10 Configuration	29
2.4.1 Profibus DP	6	A.10.1 Slot 9	29
2.4.2 Profibus and ABB products	6	A.11 Configuration	30
3 Communication level	7	A.11.1 Slot 10	30
4 Profibus communications	8	A.12 Configuration	38
4.1 Profibus DP transmission technology	8	A.12.1 Slot 11 – tags	38
4.2 Acronyms and abbreviations	8	A.13 Signal source list	38
4.3 Profibus interface	8	A.14 Engineering ranges – dissolved oxygen	39
4.4 Installation overview	8	A.15 Signal view allocations	39
4.5 Cable length	9	A.16 Profibus units	39
4.6 Cable specification	9	Appendix B – MODBUS tables	40
4.7 Network connection	9	B.1 Digital inputs	40
4.8 Configuration	10	B.1.1 Sensor reading diagnostics	40
4.8.1 Setting the Profibus slave address	10	B.1.2 Transmitter function diagnostics	40
4.8.2 Integration using GSD	11	B.1.3 Sensor function diagnostics	40
4.9 Aztec AWT440 Profibus data sheet	11	B.1.4 Transmitter diagnostics	40
4.10 Declaration of Profibus conformance	12	B.1.5 Sensor 1 (single-stream) diagnostics	40
5 MODBUS communications	13	B.1.6 Sensor 2 diagnostics	40
5.1 Host computer serial communications	13	B.1.7 Sensor 3 diagnostics	41
5.2 Two-wire and four-wire connection	14	B.1.8 Sensor 4 diagnostics	41
5.3 Pull-up and pull-down resistors	14	B.1.9 Multi-stream sensor diagnostics	41
5.4 Termination resistor	14	B.1.10 Relay state diagnostics	41
5.5 Serial connections	14	B.1.11 Digital I/O diagnostics	41
6 Ethernet communications	15	B.2 Digital outputs	42
6.1 Ethernet connection	15	B.3 Read-only, single precision float	42
Appendix A – Profibus tables	16	B.3.1 Measurement values – see engineering ranges table (Section B.12, page 49)	42
A.1 Module definitions in GSD file for cyclic read	16	B.3.2 Measurement range limits	42
A.2 Slot 1 – digital inputs	16	B.3.3 Sensor signals view – see signal view allocations table (Section B.12.2, page 49)	43
A.2.1 Slot 1 – transmitter diagnostics	17	B.3.4 Analog outputs	43
A.2.2 Slot 1 – sensor 1 diagnostics	18	B.3.5 Sensor calibration values (RDO only)	43
A.2.3 Slot 1 – sensor 2 diagnostics	19	B.4 Read only 32 bits	43
A.2.4 Slot 1 – sensor 3 diagnostics	20	B.4.1 Transmitter date (number of seconds since 01/01/2000)	43
A.2.5 Sensor 4 diagnostics	21	B.4.2 Sensor dates (number of seconds since 01/01/2000)	43
A.2.6 Slot 1 – relay status	21	B.5 Read only 16 bits – sensor hardware version (valid range 1 to 9)	43
A.2.7 Slot 1 – relay status	22	B.6 Read-only 8 bits	43
A.2.8 Slot 1 – relay status	22	B.6.1 Sensor type – see sensor type valid range table (Section B.12.3, page 50)	43
A.3 Digital outputs	23	B.6.2 Media card version	43

- B.7 Read-only strings 43
- B.8 Writable floats 44
 - B.8.1 Chart trace range –
see engineering ranges table..... 44
 - B.8.2 Sensor coefficients (turbidity only) 44
 - B.8.3 Alarm settings 44
 - B.8.4 Analog output settings –
see engineering ranges table 44
 - B.8.5 Sensor calibration correction (RDO only) –
see engineering ranges table44
- B.9 Writable 16 bits – alarm time hysteresis
(valid range 0 to 9999 seconds) 44
- B.10 Writable 8 bits 45
 - B.10.1 Measurement units 45
 - B.10.2 Digital filter 45
 - B.10.3 PV signal resolution 45
 - B.10.4 Sensor Clean Settings 46
 - B.10.5 Sensor measurement hold 46
 - B.10.6 Operator page templates 46
 - B.10.7 Data view/ log enables 46
 - B.10.8 Date display settings 47
 - B.10.9 Alarm settings 47
 - B.10.10 Analog output settings 47
 - B.10.11 Digital I/O settings 48
 - B.10.12 Relay settings 48
- B.11 Writable strings 48
 - B.11.1 16 Byte strings 48
 - B.11.2 3 Byte strings 48
- B.12 Engineering ranges 49
 - B.12.1 Signal source list 49
 - B.12.2 Signal view allocations (RDO) 49
 - B.12.3 Sensor type valid range 50
 - B.12.4 Clean frequency 50
 - B.12.5 Clean pulses 50
 - B.12.6 Clean recovery time 50
 - B.12.7 Clean output assignment 50

Appendix C – Acknowledgements50

1 Health & Safety

1.1 Document symbols

Symbols that appear in this document are explained below:



DANGER – Serious damage to health / risk to life

This symbol in conjunction with the signal word 'DANGER' indicates an imminent electrical hazard. Failure to observe this safety information will result in death or severe injury.



WARNING – Bodily injury

This symbol in conjunction with the signal word 'WARNING' indicates a potential electrical hazard. Failure to observe this safety information will result in death or severe injury.



CAUTION – Minor injuries

This symbol in conjunction with the signal word 'CAUTION' indicates a potentially dangerous situation. Failure to observe this safety information may result in minor or moderate injury. The symbol may also be used for property damage warnings.



NOTICE – Property damage

This symbol indicates a potentially damaging situation. Failure to observe this safety information may result in damage to or destruction of the product and / or other system components.



IMPORTANT (NOTE)

This symbol indicates operator tips, particularly useful information or important information about the product or its further uses. The signal word 'IMPORTANT (NOTE)' does not indicate a dangerous or harmful situation.

1.2 Safety precautions

Be sure to read, understand and follow the instructions contained within this manual before and during use of the equipment. Failure to do so could result in bodily harm or damage to the equipment.



WARNING – Bodily injury Installation, operation, maintenance and servicing must be performed:

- by suitably trained personnel only
 - in accordance with the information provided in this manual
 - in accordance with relevant local regulations
-

1.3 Potential safety hazards

1.3.1 Aztec AWT440 transmitter – electrical



WARNING – Bodily injury

To ensure safe use when operating this equipment, the following points must be observed:

- Up to 240 V AC may be present. Be sure to isolate the supply before removing the terminal cover.
- Normal safety precautions must be taken to avoid the possibility of an accident occurring when operating in conditions of high pressure and / or temperature.







Safety advice concerning the use of the equipment described in this manual or any relevant Material Safety Data Sheets (where applicable) can be obtained from the Company, together with servicing and spares information.

1.4 Safety standards

This product has been designed to satisfy the requirements of IEC61010-1:2010 3rd edition 'Safety Requirements for Electrical Equipment for Measurement, Control and Laboratory Use' and complies with US NEC 500, NIST and OSHA.

1.5 Product symbols

Symbols that appear on this product are shown below:

	Functional earth (ground) terminal.
	Alternating current supply only.
	This symbol, when noted on a product, indicates a potential hazard which could cause serious personal injury and / or death. The user should reference this instruction manual for operation and / or safety information.
	This symbol, when noted on a product enclosure or barrier, indicates that a risk of electrical shock and / or electrocution exists and indicates that only individuals qualified to work with hazardous voltages should open the enclosure or remove the barrier.
	The equipment is protected through double insulation.
	Recycle separately from general waste under the WEEE directive.

1.6 Product recycling and disposal (Europe only)



ABB is committed to ensuring that the risk of any environmental damage or pollution caused by any of its products is minimized as far as possible. The European Waste Electrical and Electronic Equipment (WEEE) Directive that initially came into force on 13 August 2005 aims to reduce the waste arising from electrical and electronic equipment; and improve the environmental performance of all those involved in the life cycle of electrical and electronic equipment. In conformity with European local and national regulations, electrical equipment marked with the above symbol may not be disposed of in European public disposal systems after 12th August 2005.



IMPORTANT (NOTE) For return for recycling, please contact the equipment manufacturer or supplier for instructions on how to return end-of-life equipment for proper disposal.

1.6.1 End-of-life battery disposal

The transmitter contains a small lithium battery (located on the processor / display board) that must be removed and disposed of responsibly in accordance with local environmental regulations.

1.7 Restriction of Hazardous Substances (RoHS)



The European Union RoHS Directive and subsequent regulations introduced in member states and other countries limits the use of six hazardous substances used in the manufacturing of electrical and electronic equipment. Currently, monitoring and control instruments do not fall within the scope of the RoHS Directive, however ABB has taken the decision to adopt the recommendations in the Directive as the target for all future product design and component purchasing.

2 Communications overview

Extensive communication options enable the Aztec AWT440 transmitter to be integrated into larger control systems easily or connected to other process instrumentation. The following sub-sections describe the options available.

2.1 Cyber security

This product is designed to be connected to and to communicate information and data via a digital communication interface. It is your sole responsibility to provide and continuously ensure a secure connection between the product and your network or any other network (as the case may be). You shall establish and maintain any appropriate measures (such as but not limited to the application of authentication measures etc.) to protect the product, the network, its system and the interface against any kind of security breaches, unauthorized access, interference, intrusion, leakage and/or theft of data or information.

ABB Ltd and its affiliates are not liable for damages and/or losses related to such security breaches, any unauthorized access, interference, intrusion, leakage and/or theft of data or information.

The Modbus protocol is an unsecured protocol, as such the intended application should be assessed to ensure that these protocols are suitable before implementation.

The PROFIBUS PA protocol is an unsecured protocol, as such the intended application should be assessed to ensure that these protocols are suitable before implementation.

The PROFIBUS DP protocol is an unsecured protocol, as such the intended application should be assessed to ensure that these protocols are suitable before implementation.

2.2 Ethernet

Optional Ethernet communications enable the Aztec AWT440 to be integrated in to an Ethernet network quickly.

The following functionality is provided:

— Email

Notification of a critical process event or status can be made by email. Multiple events can trigger an email that can be sent to multiple recipients.

— Webserver

Aztec AWT440's integrated webserver enables the current status of the process and controller to be viewed remotely using a standard web browser.

2.3 RS485 MODBUS

Using RS485 MODBUS, values and status can be communicated between a master (or host) computer and the AWT440 in real-time via an RS485 connection.

2.4 Profibus

Profibus is a manufacturer-independent, open Fieldbus standard for a wide range of applications in manufacturing, process and building automation. Manufacturer independence and openness are ensured by the international standard EN 50170.

Using the Profibus protocol, devices from different manufacturers exchange information on the same communications bus without the need for special interface equipment.

For further information on Profibus, refer to: www.profibus.com.

2.4.1 Profibus DP

Profibus DP is designed for high-speed data exchange and is commonly used by complex or externally-powered devices. The central controller or 'master' device (for example, PLC or PC) utilizes Profibus DP as a fast serial connection with distributed (slave) Profibus-enabled field devices.

The master device reads the input information cyclically in a defined, recurring order from the slave(s). When configuring the bus system, the user assigns an address in the range 0 to 125 to each slave device and also defines which of the slaves are to be included in, or excluded from, the data acquisition cycle.



2.4.2 Profibus and ABB products

Aztec AWT440 utilizes Profibus DP as this protocol is optimized for high speed and low connection costs (see www.abb.com/fieldbus and follow the Profibus link).

3 Communication level

i IMPORTANT (NOTE) Communication level menus are enabled only if an optional communications module is fitted and the parameters displayed are specific to the type of module fitted. For example, if a MODBUS module is fitted, MODBUS parameters are enabled, but Ethernet parameters are neither enabled nor displayed.

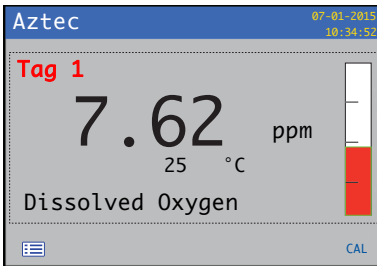

The Communication level is accessed from the Advanced access level. To access the communication level and the configuration parameters for the communications module fitted:

1. Press the  key (below the  icon on any Operator page).



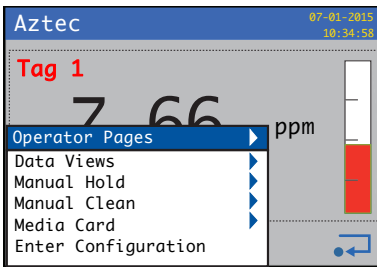

The Operator menu is displayed:



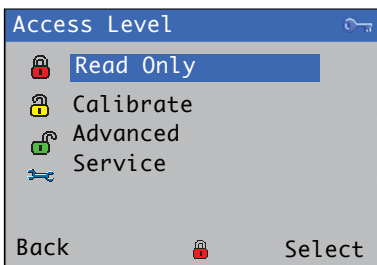

2. Press the  key to scroll to Enter Configuration and press the  key.

The Access Level page is displayed:



3. Use the  key to scroll to Advanced and press the  key (below the **Select** prompt).

4. Use the  and  keys to scroll to the Communication level:

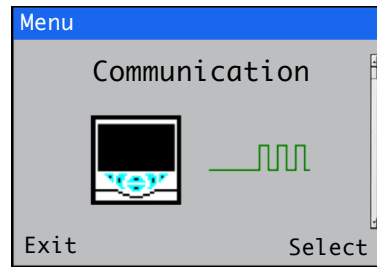

5. Press the  key (below the **Select** prompt).

The Communication page appropriate to the communication module fitted is displayed:

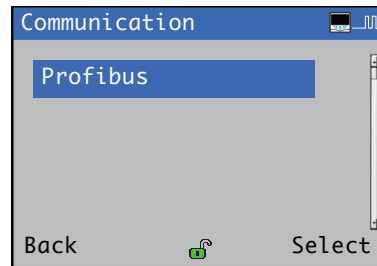

Profibus – refer to Section 4, page 8.

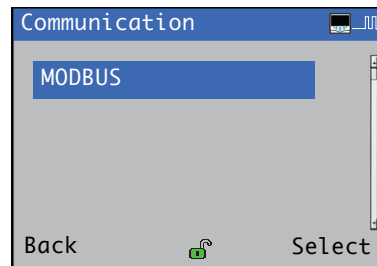

MODBUS – refer to Section 5, page 13.

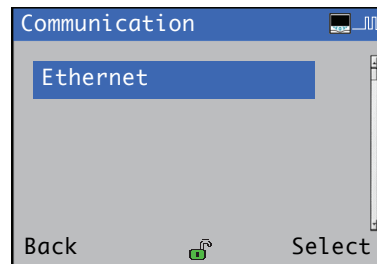

Ethernet – refer to Section 6, page 15.

4 Profibus communications

i IMPORTANT (NOTE)

Profibus menus are displayed only if a Profibus communications module is fitted.

This Section contains information specific to the Profibus-enabled Aztec AWT440 with RS485 physical layer.

It must be read in conjunction with the Operating instruction OI/AWT440-EN.

4.1 Profibus DP transmission technology

The most common transfer method of Profibus-DP is RS485 – a proven technology. A twisted, shielded, 2-wire copper cable is used as the transfer medium.

The bus structure enables addition and removal of stations or step-by-step commissioning of the system without affecting other stations. Later expansion has no influence on stations already in operation.

Transmission speeds from 9.6 kbps up to 12 Mbps are supported. One uniform transmission speed is selected for all devices on the bus when the system is commissioned.

4.2 Acronyms and abbreviations

Input	Data passed into a Master device (for example, from a Slave device)
I&M	Profibus Identification and Maintenance function
MS1	Class 1 Master-Slave acyclic transaction
Output	Data passed out of a Master device (for example, to a Slave device)
PCS/DCS	Process control system / distributed control system
PI/PNO	Profibus International / Profibus User Organization (www.profibus.com)

4.3 Profibus interface

Physical layer	RS485
Supported baud rates	9.6 kbps to 12 Mbps
Supported DP Protocol services	DPV0, DPV1
Concurrent MS2 connections	1
Device stub length	250 mm (9.8 in.)
Master components available	GSD

4.4 Installation overview

All devices are connected in a bus structure ('line') as shown in Fig 4.1. Up to 32 stations (master or slaves) can be linked to create one 'segment', although it is recommended not to install more than 16 devices on a single segment.

Each end of a segment must be terminated by an active bus terminating resistor. Both bus terminators must always be powered to ensure fault-free operation, therefore it is strongly recommended that they are connected to a back-up power supply. The use of bus amplifiers (repeaters) and segment couplers can be used to extend the network.

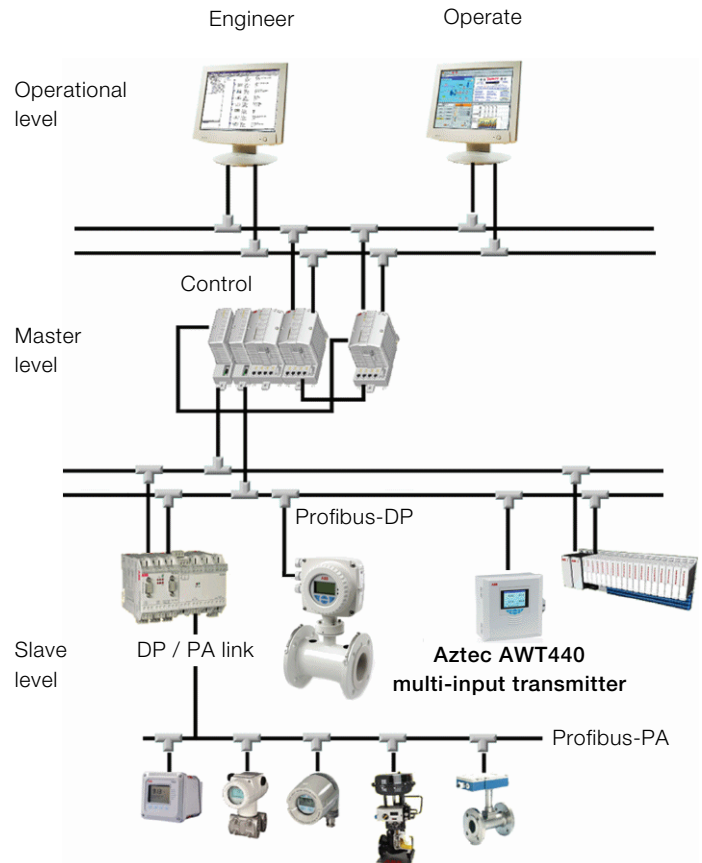

Fig. 4.1 Typical Profibus network

4.5 Cable length

The maximum cable length of a segment is determined by the transmission speed (see Table 4.1). The cable length specified can be extended using repeaters, but it is recommended that no more than 3 repeaters are connected in series.

Transmission rate (bits per second)	Maximum segment length in m (ft.)	Maximum total network length in m (ft.)
9.6 to 93.75 kbps	1200 (3937)	4800 (15748)
187.5 kbps	1000 (3280)	4000 (13123)
500 kbps	400 (1312)	1600 (5249)
1.5 Mbps	200 (656)	800 (2624)
3 to 12 Mbps	100 (328)	400 (1312)

Table 4.1 Cable length

4.6 Cable specification

The cable lengths in Table 4.1 apply to cable to the following specification:

Impedance	135 to 165 Ω
Capacitance per unit length	<30 pf/m
Loop resistance	110 Ω /km
Core diameter	0.64 mm
Core cross section	>0.34 mm ²

Suitable Profibus cable (part numbers PCA010, PCA011 and PCA012) can be obtained from ABB. Refer to Data Sheet 10/63-6.46-EN.

4.7 Network connection



WARNING – Bodily injury

Refer to the Aztec AWT440 Operating instruction (OI/AWT440-EN) before making electrical connections.



NOTICE – Property damage

When connecting an Aztec AWT440 to a Profibus-DP RS485 network:

- Use cable that meets Profibus specifications for reliable RS485 communications – see Section 4.6.
- Ensure RS485 signals are not reversed.
- Ensure a Profibus active terminator is fitted to each end of each RS485 bus segment.
- Route data lines clear of the source of any strong electrical and magnetic fields.

Profibus network connections are made to the terminal blocks on the Aztec AWT440 PCB located behind the PCB terminal cover – refer to Section 4 of the Operating instruction (OI/AWT440-EN).

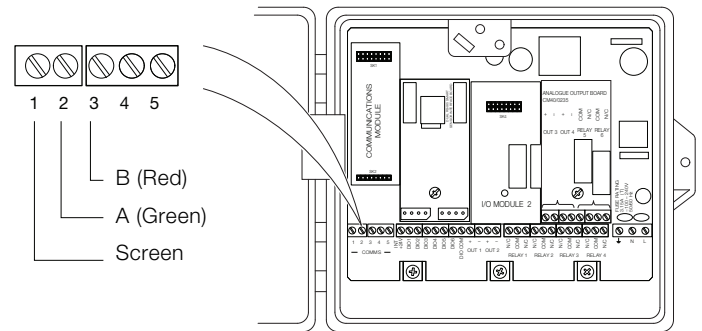

Fig. 4.2 Aztec AWT440 PCB connections to Profibus network

Data signal	Cable color	Description
A	Green	Negative (-) data line: connect to pin 8 on Profibus DP equipment with 9-way D-type connectors.
B	Red	Positive (+) data line: connect to pin 3 on Profibus DP equipment with 9-way D-type connectors.
Braided screen	N/A	Cable screen – usually connected to the D-type shell or pin 1 on Profibus DP equipment with 9-way D-type connectors.

Table 4.2 Profibus DP data cable signals

4.8 Configuration

4.8.1 Setting the Profibus slave address

Menu	Comment	Default
Profibus		
Slave Address	Set a device-specific slave address to identify the transmitter on the network.	
Baud Rate	Displays a read-only value (range 0 to 12000 K baud) read from the network the Aztec AWT440 is connected to.	

The Profibus slave address for an Aztec AWT440 transmitter can be set locally using the keypad and menus or remotely by a master using the SET_SLAVE_ADDRESS service.



When the Profibus master sets the transmitter's slave address, the address is stored and overwrites the value previously held in the transmitter.

To change the Slave Address locally using the keypad and menus:



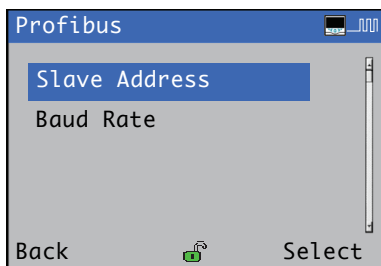



1. Refer to Section 3, page 7 and access the Profibus communication page.
2. Press the  key (below the **Select** prompt).



The Profibus page is displayed:



3. Use the  and  keys to scroll to Slave Address and press the  key (below the **Select** prompt).

The current Slave Address setting is displayed.

4. To edit the Slave Address value, press the  key to enter the Slave Address edit page.
5. Use the  key to move between editable numbers and use the  and  keys to increase / decrease each number.
6. Press the  key to accept the new value and exit the Slave Address page, then press the  key repeatedly to return to the Operator page.

i IMPORTANT (NOTE) To cancel a changed value, press and hold (or press repeatedly) the  key (below the **Next** prompt) until the **Cancel** prompt is displayed at the bottom right side off the page, then press the  key to return to the previous page.

4.8.2 Integration using GSD

Profibus devices differ with respect to available functionality and parameters for each device type and manufacturer. In order to obtain 'Plug-and-Play' configuration for Profibus, characteristic device communication features such as manufacturer name, device name, hardware / software versions, baud rate and the number and nature of inputs / outputs are defined in an electronic device data sheet known as a GSD (Generic Station Description) file.

A GSD file is readable ASCII text file that contains both general and device-specific specifications for communication. Each of the entries describes a feature supported by a device. By using keywords, a configuration tool reads the device identification, the adjustable parameters, the corresponding data type and the permitted limit values for the configuration of the device from the GSD. Some keywords are mandatory (for example, Vendor_Name), others are optional (for example, Sync_Mode_supported).

The GSD file for Aztec AWT440 transmitters specifies the device-specific Ident No. 3403 and conforms to the Profibus standard, providing a clear and comprehensive description of each instrument in a precisely defined format. The description enables the system configuration tool to use the information automatically when configuring a Profibus bus system.

The ABB GSD file (Ident No. 3403) is divided into 2 sections:

— **General specifications**

Identification of the device, together with hardware and software versions, baud rates supported and the possible time intervals for monitoring times.

— **DP Slave-related specifications**

Information about the user parameter block for device-specific configuration and modules containing details of the input and output data that can be exchanged cyclically with a Profibus master.

The Aztec AWT440 GSD file (ABB_3403.gsd) is available for download from the ABB website at: www.abb.com/fieldbus (follow the link for Profibus DP field devices).

4.9 Aztec AWT440 Profibus data sheet

Item	Detail
Profibus device name	Aztec 400 (product: AWT440)
Applicable standards	IEC61158 (Type 3) IEC61784 (CPF3/1)
Protocols supported	Profibus-DP (DPV0) Profibus-DP extensions (DPV1 Class 1 and 2 supported)
Profile ident support	0x3403
Profibus unit type	Profibus DPV1 Slave
Profibus media type	RS485 (EIA-485), galvanically isolated
Profibus bus connection	Wiring terminals A1/B1 (in) and A2/B2 (out)
Profibus slot / index	Profibus commands must include length (in bytes) as well as slot / index. This is so that multiple values from the same slot (except strings) can be read / written in a single transaction (up to the maximum of 240 bytes). The length for a multiple index read must be a multiple of the number of bytes value for the required slot multiplied by the number of values to be read. The index specifies the starting index for the values returned. The starting index plus the number of bytes must not go beyond the end of the table. Strings must also specify the correct length in bytes but only single strings can be accessed in one transaction.
Bus address range	1 to 126 via local display interface 1 to 125 via Set_Slave_Addr service
Baud rates supported	9.6 kbps 19.2 kbps 45.45 kbps 93.75 kbps 187.5 kbps 500 kbps 1.5 Mbps 3 Mbps 6 Mbps 12 Mbps
Master Class 1 – Slave cyclic services (MS0)	Set_Prm Chk_Cfg Set_Slave_Addr Data_Exchange Get_Diag Get_Cfg Rd_Inp Rd_Outp
Master Class 1 – Slave acyclic services (MS1)	MS1_Read MS1_Write
Device-specific GSD file	ABB_3403.gsd
Configuration support	Local display interface

4.10 Declaration of Profibus conformance

Aztec 400 is the PNO registered model name for Profibus-enabled Aztec AWT440 transmitters (RS485 physical layer) approved by an independent authorized certification laboratory for connection and use in Profibus networks.

Certification of Profibus specification conformance covers the following areas:

- RS485 bus interface electrical characteristics.
- DPV0 and DPV1 protocol services.
- AWT440-DP device-specific GSD file (ABB_3403.gsd).

A copy of the conformance certificate is available for download from the Aztec AWT440 product pages of the ABB website www.abb.com.

5 MODBUS communications



IMPORTANT (NOTE)

MODBUS menus are enabled only if a MODBUS communications module is fitted.

This section describes the connection of serial data cables between the master (host computer) and slave (Aztec AWT440 transmitter) on a MODBUS serial link.

Menu	Comment	Default
MODBUS		
Device Address	Set a device-specific address (from 1 to 247) to identify the transmitter on a MODBUS link.	
RS485 Setup		
Mode	Select the MODBUS serial communication serial link type: 2 Wire, 4 Wire or Off	4 Wire
Baud Rate	Select a communication transfer rate: 1200, 2400, 4800, 9600, 19200, 38400 or 115200 baud.	19200
Parity	Select the parity bit (transmission error-checking) condition: No Parity, Odd Parity or Even Parity	No Parity
Tx Delay	Set a delay to the response from the transmitter in milliseconds. Maximum delay 100 ms.	50 ms

5.1 Host computer serial communications

The serial interface option module operates using the MODBUS Remote Terminal Unit (RTU) Master / Slave protocol. An appropriate RS422 / 485 communications driver must be fitted to the host (master) computer. It is strongly recommended that the interface has galvanic isolation to protect the computer from lightning damage and to increase signal immunity to noise pick-up.



IMPORTANT (NOTE)

The MODBUS option provides the following facilities:

- Standard RS422/485 communications.
- MODBUS RTU protocol – the transmitter is designed to operate as a Remote Terminal Unit (RTU) slave when communicating with a master (host) system.
- 500V DC isolation from external connections to the instrument.
- Two- or four-wire communication (selected at the RS485 Setup / Mode parameter).
- 1200, 2400, 4800, 9600, 19200, 38400, or 115200 baud transmission rate.
- Parity-checking (odd, even or none).



WARNING – Bodily injury

Refer to the Aztec AWT440 Operating instruction (OI/AWT440-EN) before making electrical connections.

5.2 Two-wire and four-wire connection

MODBUS serial communications can be configured as either 2-wire or 4-wire serial links – see Fig. 5.1. The transmitter must be added to the link configuration on the host system – refer to information supplied with the host system.

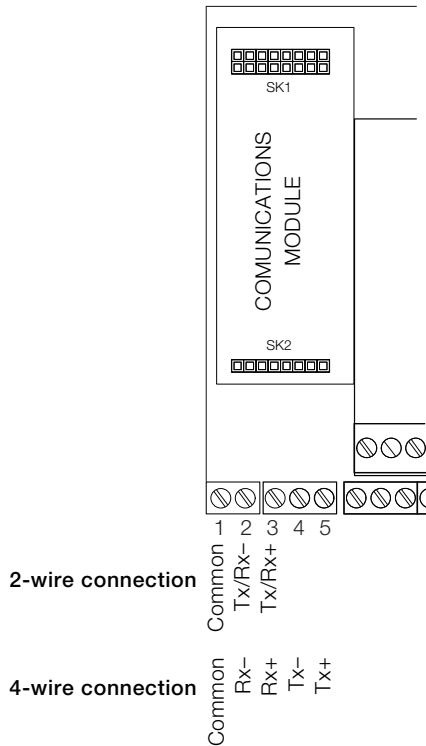

Fig. 5.1 2-wire and 4-wire MODBUS serial links

5.3 Pull-up and pull-down resistors

To prevent false triggering of slaves when the master (host computer) is inactive, fit pull-up and pull-down resistors to the RS422/485 interface in the host computer.

Resistors are normally connected to the interface by hard-wired links or switches – refer to the manufacturer's instructions

5.4 Termination resistor

For long transmission lines, fit 120 Ω termination resistors to the last slave in the chain and the master receiver – see Fig. 5.2.

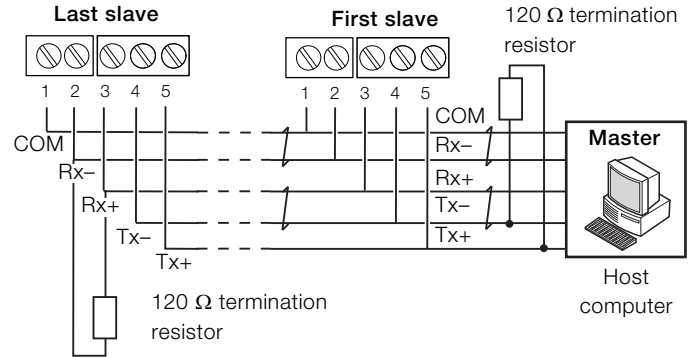

Fig. 5.2 Connecting multiple slaves

5.5 Serial connections

Make connections to the MODBUS serial board as shown in Fig. 5.1. On systems with multiple slaves, make connections to two- or four-wire link configurations in parallel as shown in Fig. 5.2. When connecting cable screens, ensure that ground loops are not introduced.

The maximum serial data transmission line length for both RS422 and RS485 systems is 1200 m (3937 ft.).

The types of cable that can be used are determined by the total line length:

- Up to 6 m (19.7 ft.) – standard screened or twisted pair cable.
- Up to 300 m (984 ft.) – twin twisted pair with overall foil screen and an integral drain wire.
- Up to 1200 m (3937 ft.) – twin twisted pair with separate foil screens and integral drain wires.

6 Ethernet communications

Ethernet and email menus are enabled only if an Ethernet communications module is fitted.

Menu	Comment	Default
Ethernet		
DHCP	Select to enable or disable DHCP (Dynamic Host Control Protocol). Enabled – select if the IP address is to be allocated dynamically by the network. Disabled – select if the IP address is defined statically.	Enabled
IP Address *	Enter an IP address assigned to the transmitter. The IP address is used by the TCP/IP protocol to distinguish between different devices. The address is a 32-bit value expressed with 4 values (0 to 255), each separated by a period (.)	000.000. 000.000
* Displayed only if DHCP is set to Disabled		
Subnet Mask	Enter a subnet mask to indicate which part of the IP address is used for the network ID and which part is used for the host ID. Set each bit that is part of the network ID as '1's, for example: 255.255.255.0 indicates the first 24 bits are for the network ID.	Class Default
Default Gateway	Enter the IP address for the Default Gateway (router or switch) used to communicate with other networks. Note. This setting is required only if a router (or switch) is used.	000.000. 000.000
Email		
SMTP Server ID	Enter the IP address of the SMTP (Simple Mail Transport Protocol) server used to distribute emails.	000.000. 000.000
Recipients		
Email Address 1 (to 3)	Enter the email address(es) of the recipient(s).	
Triggers		
Tag 1 (to 4)	Enter an alphanumeric tag (16 characters maximum) that appears in the subject title to identify the trigger.	
Source 1 (to 4)	Select to enable up to 4 independently-configurable triggers to generate an email when the selected source becomes active (the email can be sent to up to 3 recipients).	
Invert 1 (to 4)	If enabled, an email is generated when the Source becomes inactive instead of active.	

6.1 Ethernet connection

Referring to Fig. 6.1:

1. Isolate the transmitter from the power supply.
2. Using a suitable screwdriver, release transmitter door retaining screw (A) and open the door.
3. Unscrew terminal cover screw (B) and remove terminal cover.
4. Route ethernet cable through a suitable cable entry hole (C).

i IMPORTANT (NOTE) Fit cable gland to ethernet cable to maintain IP rating, as required.

5. Connect ethernet cable plug to socket on ethernet board (D).
6. Refit terminal cover and secure with screw (B).
7. Close transmitter door and secure with door retaining screw (A).
8. Restore the transmitter's power supply.

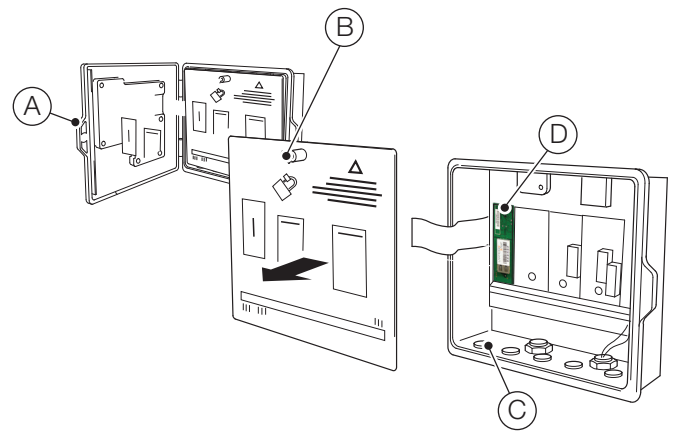

Fig. 6.1 Ethernet connection

Appendix A – Profibus tables

A.1 Module definitions in GSD file for cyclic read

Module 1	Sensor 1 PV (4-bytes float)	Sensor 1 SV (4-bytes float)						
Module 2	Sensor 1 PV (4-bytes float)	Sensor 1 SV (4-bytes float)	Sensor 2 PV (4-bytes float)	Sensor 2 SV (4-bytes float)				
Module 3	Sensor 1 PV (4-bytes float)	Sensor 1 SV (4-bytes float)	Sensor 2 PV (4-bytes float)	Sensor 2 SV (4-bytes float)	Sensor 3 PV (4-bytes float)	Sensor 3 SV (4-bytes float)		
Module 4	Sensor 1 PV (4-bytes float)	Sensor 1 SV (4-bytes float)	Sensor 2 PV (4-bytes float)	Sensor 2 SV (4-bytes float)	Sensor 3 PV (4-bytes float)	Sensor 3 SV (4-bytes float)	Sensor 4 PV (4-bytes float)	Sensor 4 SV (4-bytes float)

A.2 Slot 1 – digital inputs

Description	Slot	Index	Object type	Data type	Bytes	Store	Access	Default	Valid range
Sensor 1 concentration value status	1	0	Simple	Unsigned 8	1	D	R	Inactive	0 – Inactive 1 – Active
Sensor 1 temperature value status	1	1	Simple	Unsigned 8	1	D	R	Inactive	
Sensor 2 concentration value status	1	2	Simple	Unsigned 8	1	D	R	Inactive	
Sensor 2 temperature value status	1	3	Simple	Unsigned 8	1	D	R	Inactive	
Sensor 3 concentration value status	1	4	Simple	Unsigned 8	1	D	R	Inactive	
Sensor 3 temperature value status	1	5	Simple	Unsigned 8	1	D	R	Inactive	
Sensor 4 concentration value status	1	6	Simple	Unsigned 8	1	D	R	Inactive	
Sensor 4 temperature value status	1	7	Simple	Unsigned 8	1	D	R	Inactive	
Transmitter failure diagnostic	1	8	Simple	Unsigned 8	1	D	R	Inactive	
Transmitter out of specification diagnostic	1	9	Simple	Unsigned 8	1	D	R	Inactive	
Transmitter maintenance diagnostic	1	10	Simple	Unsigned 8	1	D	R	Inactive	
Transmitter function check diagnostic	1	11	Simple	Unsigned 8	1	D	R	Inactive	
Sensor 1 failure diagnostic	1	12	Simple	Unsigned 8	1	D	R	Inactive	
Sensor 1 out of specification diagnostic	1	13	Simple	Unsigned 8	1	D	R	Inactive	
Sensor 1 maintenance diagnostic	1	14	Simple	Unsigned 8	1	D	R	Inactive	
Sensor 1 function check diagnostic	1	15	Simple	Unsigned 8	1	D	R	Inactive	
Sensor 2 failure diagnostic	1	16	Simple	Unsigned 8	1	D	R	Inactive	
Sensor 2 out of specification diagnostic	1	17	Simple	Unsigned 8	1	D	R	Inactive	
Sensor 2 maintenance diagnostic	1	18	Simple	Unsigned 8	1	D	R	Inactive	
Sensor 2 function check diagnostic	1	19	Simple	Unsigned 8	1	D	R	Inactive	
Sensor 3 failure diagnostic	1	20	Simple	Unsigned 8	1	D	R	Inactive	
Sensor 3 out of specification diagnostic	1	21	Simple	Unsigned 8	1	D	R	Inactive	
Sensor 3 maintenance diagnostic	1	22	Simple	Unsigned 8	1	D	R	Inactive	
Sensor 3 function check diagnostic	1	23	Simple	Unsigned 8	1	D	R	Inactive	
Sensor 4 failure diagnostic	1	24	Simple	Unsigned 8	1	D	R	Inactive	
Sensor 4 out of specification diagnostic	1	25	Simple	Unsigned 8	1	D	R	Inactive	
Sensor 4 maintenance diagnostic	1	26	Simple	Unsigned 8	1	D	R	Inactive	
Sensor 4 function check diagnostic	1	27	Simple	Unsigned 8	1	D	R	Inactive	

A.2.1 Slot 1 – transmitter diagnostics

Description	Slot	Index	Object type	Data type	Bytes	Store	Access	Default	Valid range
NV Error Proc Bd	1	28	Simple	Unsigned 8	1	D	R	Inactive	0 – Inactive 1 – Active
NV Error Main Bd	1	29	Simple	Unsigned 8	1	D	R	Inactive	
NV Error Option Bd 1	1	30	Simple	Unsigned 8	1	D	R	Inactive	
NV Error Option Bd 2	1	31	Simple	Unsigned 8	1	D	R	Inactive	
NV Error Comm Bd	1	32	Simple	Unsigned 8	1	D	R	Inactive	
NV Error SW Key1	1	33	Simple	Unsigned 8	1	D	R	Inactive	
NV Error SW Key2	1	34	Simple	Unsigned 8	1	D	R	Inactive	
NV Error SW Key3	1	35	Simple	Unsigned 8	1	D	R	Inactive	
Int. Comms Error	1	36	Simple	Unsigned 8	1	D	R	Inactive	
Internal Temp High	1	37	Simple	Unsigned 8	1	D	R	Inactive	
Internal Temp Low	1	38	Simple	Unsigned 8	1	D	R	Inactive	
Excessive Sensor Current	1	39	Simple	Unsigned 8	1	D	R	Inactive	
Invalid Configuration	1	40	Simple	Unsigned 8	1	D	R	Inactive	
Simulation On	1	41	Simple	Unsigned 8	1	D	R	Inactive	
In Manual Test	1	42	Simple	Unsigned 8	1	D	R	Inactive	
In Configuration	1	44	Simple	Unsigned 8	1	D	R	Inactive	
Below Compensation Range	1	45	Simple	Unsigned 8	1	D	R	Inactive	
Before Cation High	1	46	Simple	Unsigned 8	1	D	R	Inactive	
Before Cation Low	1	47	Simple	Unsigned 8	1	D	R	Inactive	
After Cation High	1	48	Simple	Unsigned 8	1	D	R	Inactive	
Inferred pH Invalid	1	49	Simple	Unsigned 8	1	D	R	Inactive	
Media Card Full	1	50	Simple	Unsigned 8	1	D	R	Inactive	
Media Near Full	1	51	Simple	Unsigned 8	1	D	R	Inactive	

A.2.2 Slot 1 – sensor 1 diagnostics

Description	Slot	Index	Object type	Data type	Bytes	Store	Access	Default	Valid range
Sensor Removed	1	52	Simple	Unsigned 8	1	D	R	Inactive	0 – Inactive 1 – Active
PV Failure	1	53	Simple	Unsigned 8	1	D	R	Inactive	
SV Failure	1	54	Simple	Unsigned 8	1	D	R	Inactive	
ADC Failure	1	55	Simple	Unsigned 8	1	D	R	Inactive	
NV Failure	1	56	Simple	Unsigned 8	1	D	R	Inactive	
Commission Failed	1	57	Simple	Unsigned 8	1	D	R	Inactive	
Glass Error	1	58	Simple	Unsigned 8	1	D	R	Inactive	
Reference Error	1	59	Simple	Unsigned 8	1	D	R	Inactive	
Calibrating	1	60	Simple	Unsigned 8	1	D	R	Inactive	
Recovery	1	61	Simple	Unsigned 8	1	D	R	Inactive	
Cap Removed	1	62	Simple	Unsigned 8	1	D	R	Inactive	
Hold	1	63	Simple	Unsigned 8	1	D	R	Inactive	
Wash in Progress	1	64	Simple	Unsigned 8	1	D	R	Inactive	
Wash Inhibited	1	65	Simple	Unsigned 8	1	D	R	Inactive	
Calibration Failed	1	66	Simple	Unsigned 8	1	D	R	Inactive	
Low pH Slope	1	67	Simple	Unsigned 8	1	D	R	Inactive	
PV Out of Range	1	68	Simple	Unsigned 8	1	D	R	Inactive	
SV Out of Range	1	69	Simple	Unsigned 8	1	D	R	Inactive	
Excess Ambient Light	1	70	Simple	Unsigned 8	1	D	R	Inactive	
Lamp Life Expired	1	71	Simple	Unsigned 8	1	D	R	Inactive	
Wiper Blade Expired	1	72	Simple	Unsigned 8	1	D	R	Inactive	
Service Overdue	1	73	Simple	Unsigned 8	1	D	R	Inactive	
Reference Warning	1	74	Simple	Unsigned 8	1	D	R	Inactive	
Ambient Temp Range	1	75	Simple	Unsigned 8	1	D	R	Inactive	
Led Expired	1	76	Simple	Unsigned 8	1	D	R	Inactive	
Replace RDO Cap	1	77	Simple	Unsigned 8	1	D	R	Inactive	
Low Electrolyte	1	78	Simple	Unsigned 8	1	D	R	Inactive	
Cap Expired	1	79	Simple	Unsigned 8	1	D	R	Inactive	
Sample Flow Error	1	80	Simple	Unsigned 8	1	D	R	Inactive	
Service Due	1	81	Simple	Unsigned 8	1	D	R	Inactive	
Out of Solution	1	82	Simple	Unsigned 8	1	D	R	Inactive	
Wiper Failed	1	83	Simple	Unsigned 8	1	D	R	Inactive	
Replace Lamp	1	84	Simple	Unsigned 8	1	D	R	Inactive	
Replace Wiper Blade	1	85	Simple	Unsigned 8	1	D	R	Inactive	

A.2.3 Slot 1 – sensor 2 diagnostics

Description	Slot	Index	Object type	Data type	Bytes	Store	Access	Default	Valid range
Sensor Removed	1	86	Simple	Unsigned 8	1	D	R	Inactive	0 – Inactive 1 – Active
PV Failure	1	87	Simple	Unsigned 8	1	D	R	Inactive	
SV Failure	1	88	Simple	Unsigned 8	1	D	R	Inactive	
ADC Failure	1	89	Simple	Unsigned 8	1	D	R	Inactive	
NV Failure	1	90	Simple	Unsigned 8	1	D	R	Inactive	
Commission Failed	1	91	Simple	Unsigned 8	1	D	R	Inactive	
Glass Error	1	92	Simple	Unsigned 8	1	D	R	Inactive	
Reference Error	1	93	Simple	Unsigned 8	1	D	R	Inactive	
Calibrating	1	94	Simple	Unsigned 8	1	D	R	Inactive	
Recovery	1	95	Simple	Unsigned 8	1	D	R	Inactive	
Cap Removed	1	96	Simple	Unsigned 8	1	D	R	Inactive	
Hold	1	97	Simple	Unsigned 8	1	D	R	Inactive	
Wash in Progress	1	98	Simple	Unsigned 8	1	D	R	Inactive	
Wash Inhibited	1	99	Simple	Unsigned 8	1	D	R	Inactive	
Calibration Failed	1	100	Simple	Unsigned 8	1	D	R	Inactive	
Low pH Slope	1	101	Simple	Unsigned 8	1	D	R	Inactive	
PV Out of Range	1	102	Simple	Unsigned 8	1	D	R	Inactive	
SV Out of Range	1	103	Simple	Unsigned 8	1	D	R	Inactive	
Excess Ambient Light	1	104	Simple	Unsigned 8	1	D	R	Inactive	
Lamp Life Expired	1	105	Simple	Unsigned 8	1	D	R	Inactive	
Wiper Blade Expired	1	106	Simple	Unsigned 8	1	D	R	Inactive	
Service Overdue	1	107	Simple	Unsigned 8	1	D	R	Inactive	
Reference Warning	1	108	Simple	Unsigned 8	1	D	R	Inactive	
Ambient Temp Range	1	109	Simple	Unsigned 8	1	D	R	Inactive	
Led Expired	1	110	Simple	Unsigned 8	1	D	R	Inactive	
Replace RDO Cap	1	111	Simple	Unsigned 8	1	D	R	Inactive	
Low Electrolyte	1	112	Simple	Unsigned 8	1	D	R	Inactive	
Cap Expired	1	113	Simple	Unsigned 8	1	D	R	Inactive	
Sample Flow Error	1	114	Simple	Unsigned 8	1	D	R	Inactive	
Service Due	1	115	Simple	Unsigned 8	1	D	R	Inactive	
Out of Solution	1	116	Simple	Unsigned 8	1	D	R	Inactive	
Wiper Failed	1	117	Simple	Unsigned 8	1	D	R	Inactive	
Replace Lamp	1	118	Simple	Unsigned 8	1	D	R	Inactive	
Replace Wiper Blade	1	119	Simple	Unsigned 8	1	D	R	Inactive	

A.2.4 Slot 1 – sensor 3 diagnostics

Description	Slot	Index	Object type	Data type	Bytes	Store	Access	Default	Valid range
Sensor Removed	1	120	Simple	Unsigned 8	1	D	R	Inactive	0 – Inactive 1 – Active
PV Failure	1	121	Simple	Unsigned 8	1	D	R	Inactive	
SV Failure	1	122	Simple	Unsigned 8	1	D	R	Inactive	
ADC Failure	1	123	Simple	Unsigned 8	1	D	R	Inactive	
NV Failure	1	124	Simple	Unsigned 8	1	D	R	Inactive	
Commission Failed	1	125	Simple	Unsigned 8	1	D	R	Inactive	
Glass Error	1	126	Simple	Unsigned 8	1	D	R	Inactive	
Reference Error	1	127	Simple	Unsigned 8	1	D	R	Inactive	
Calibrating	1	128	Simple	Unsigned 8	1	D	R	Inactive	
Recovery	1	129	Simple	Unsigned 8	1	D	R	Inactive	
Cap Removed	1	130	Simple	Unsigned 8	1	D	R	Inactive	
Hold	1	131	Simple	Unsigned 8	1	D	R	Inactive	
Wash in Progress	1	132	Simple	Unsigned 8	1	D	R	Inactive	
Wash Inhibited	1	133	Simple	Unsigned 8	1	D	R	Inactive	
Calibration Failed	1	134	Simple	Unsigned 8	1	D	R	Inactive	
Low pH Slope	1	135	Simple	Unsigned 8	1	D	R	Inactive	
PV Out of Range	1	136	Simple	Unsigned 8	1	D	R	Inactive	
SV Out of Range	1	137	Simple	Unsigned 8	1	D	R	Inactive	
Excess Ambient Light	1	138	Simple	Unsigned 8	1	D	R	Inactive	
Lamp Life Expired	1	139	Simple	Unsigned 8	1	D	R	Inactive	
Wiper Blade Expired	1	140	Simple	Unsigned 8	1	D	R	Inactive	
Service Overdue	1	141	Simple	Unsigned 8	1	D	R	Inactive	
Reference Warning	1	142	Simple	Unsigned 8	1	D	R	Inactive	
Ambient Temp Range	1	143	Simple	Unsigned 8	1	D	R	Inactive	
Led Expired	1	144	Simple	Unsigned 8	1	D	R	Inactive	
Replace RDO Cap	1	145	Simple	Unsigned 8	1	D	R	Inactive	
Low Electrolyte	1	146	Simple	Unsigned 8	1	D	R	Inactive	
Cap Expired	1	147	Simple	Unsigned 8	1	D	R	Inactive	
Sample Flow Error	1	148	Simple	Unsigned 8	1	D	R	Inactive	
Service Due	1	149	Simple	Unsigned 8	1	D	R	Inactive	
Out of Solution	1	150	Simple	Unsigned 8	1	D	R	Inactive	
Wiper Failed	1	151	Simple	Unsigned 8	1	D	R	Inactive	
Replace Lamp	1	152	Simple	Unsigned 8	1	D	R	Inactive	
Replace Wiper Blade	1	153	Simple	Unsigned 8	1	D	R	Inactive	

A.2.5 Sensor 4 diagnostics

Description	Slot	Index	Object type	Data type	Bytes	Store	Access	Default	Valid range
Sensor Removed	1	154	Simple	Unsigned 8	1	D	R	Inactive	0 – Inactive 1 – Active
PV Failure	1	155	Simple	Unsigned 8	1	D	R	Inactive	
SV Failure	1	156	Simple	Unsigned 8	1	D	R	Inactive	
ADC Failure	1	157	Simple	Unsigned 8	1	D	R	Inactive	
NV Failure	1	158	Simple	Unsigned 8	1	D	R	Inactive	
Commission Failed	1	159	Simple	Unsigned 8	1	D	R	Inactive	
Glass Error	1	160	Simple	Unsigned 8	1	D	R	Inactive	
Reference Error	1	161	Simple	Unsigned 8	1	D	R	Inactive	
Calibrating	1	162	Simple	Unsigned 8	1	D	R	Inactive	
Recovery	1	163	Simple	Unsigned 8	1	D	R	Inactive	
Cap Removed	1	164	Simple	Unsigned 8	1	D	R	Inactive	
Hold	1	165	Simple	Unsigned 8	1	D	R	Inactive	
Wash in Progress	1	166	Simple	Unsigned 8	1	D	R	Inactive	
Wash Inhibited	1	167	Simple	Unsigned 8	1	D	R	Inactive	
Calibration Failed	1	168	Simple	Unsigned 8	1	D	R	Inactive	
Low pH Slope	1	169	Simple	Unsigned 8	1	D	R	Inactive	
PV Out of Range	1	170	Simple	Unsigned 8	1	D	R	Inactive	
SV Out of Range	1	171	Simple	Unsigned 8	1	D	R	Inactive	
Excess Ambient Light	1	172	Simple	Unsigned 8	1	D	R	Inactive	
Lamp Life Expired	1	173	Simple	Unsigned 8	1	D	R	Inactive	
Wiper Blade Expired	1	174	Simple	Unsigned 8	1	D	R	Inactive	
Service Overdue	1	175	Simple	Unsigned 8	1	D	R	Inactive	
Reference Warning	1	176	Simple	Unsigned 8	1	D	R	Inactive	
Ambient Temp Range	1	177	Simple	Unsigned 8	1	D	R	Inactive	
Led Expired	1	178	Simple	Unsigned 8	1	D	R	Inactive	
Replace RDO Cap	1	179	Simple	Unsigned 8	1	D	R	Inactive	
Low Electrolyte	1	180	Simple	Unsigned 8	1	D	R	Inactive	
Cap Expired	1	181	Simple	Unsigned 8	1	D	R	Inactive	
Sample Flow Error	1	182	Simple	Unsigned 8	1	D	R	Inactive	
Service Due	1	183	Simple	Unsigned 8	1	D	R	Inactive	
Out of Solution	1	184	Simple	Unsigned 8	1	D	R	Inactive	
Wiper Failed	1	185	Simple	Unsigned 8	1	D	R	Inactive	
Replace Lamp	1	186	Simple	Unsigned 8	1	D	R	Inactive	
Replace Wiper Blade	1	187	Simple	Unsigned 8	1	D	R	Inactive	

A.2.6 Slot 1 – relay status

Description	Slot	Index	Object type	Data type	Bytes	Store	Access	Default	Valid range
Relay 1 State	1	188	Simple	Unsigned 8	1	D	R	Deactivated	0 – Deactivated 1 – Activated
Relay 2 State	1	189	Simple	Unsigned 8	1	D	R	Deactivated	
Relay 3 State	1	190	Simple	Unsigned 8	1	D	R	Deactivated	
Relay 4 State	1	191	Simple	Unsigned 8	1	D	R	Deactivated	
Relay 5 State	1	192	Simple	Unsigned 8	1	D	R	Deactivated	
Relay 6 State	1	193	Simple	Unsigned 8	1	D	R	Deactivated	

A.2.7 Slot 1 – relay status

Description	Slot	Index	Object type	Data type	Bytes	Store	Access	Default	Valid range
Alarm 1 State	1	194	Simple	Unsigned 8	1	D	R	Deactivated	0 - Deactivated 1 - Activated
Alarm 2 State	1	195	Simple	Unsigned 8	1	D	R	Deactivated	
Alarm 3 State	1	196	Simple	Unsigned 8	1	D	R	Deactivated	
Alarm 4 State	1	197	Simple	Unsigned 8	1	D	R	Deactivated	
Alarm 5 State	1	198	Simple	Unsigned 8	1	D	R	Deactivated	
Alarm 6 State	1	199	Simple	Unsigned 8	1	D	R	Deactivated	
Alarm 7 State	1	200	Simple	Unsigned 8	1	D	R	Deactivated	
Alarm 8 State	1	201	Simple	Unsigned 8	1	D	R	Deactivated	

A.2.8 Slot 1 – relay status

Description	Slot	Index	Object type	Data type	Bytes	Store	Access	Default	Valid range
Digital output 1 State	1	202	Simple	Unsigned 8	1	D	R	Low	0 - Low 1 - High
Digital output 2 State	1	203	Simple	Unsigned 8	1	D	R	Low	
Digital output 3 State	1	204	Simple	Unsigned 8	1	D	R	Low	
Digital output 4 State	1	205	Simple	Unsigned 8	1	D	R	Low	
Digital output 5 State	1	206	Simple	Unsigned 8	1	D	R	Low	
Digital output 6 State	1	207	Simple	Unsigned 8	1	D	R	Low	
Digital input 1 State	1	208	Simple	Unsigned 8	1	D	R	Low	
Digital input 2 State	1	209	Simple	Unsigned 8	1	D	R	Low	
Digital input 3 State	1	210	Simple	Unsigned 8	1	D	R	Low	
Digital input 4 State	1	211	Simple	Unsigned 8	1	D	R	Low	
Digital input 5 State	1	212	Simple	Unsigned 8	1	D	R	Low	
Digital input 6 State	1	213	Simple	Unsigned 8	1	D	R	Low	

A.3 Digital outputs

A.3.1 Slot 1 – Alarm Acknowledge

Description	Slot	Index	Object type	Data type	Bytes	Store	Access	Default	Valid range
Alarm acknowledge state 1	2	0	Simple	Unsigned 8	1	D	R/W	Unacknowledged	0 – Unacknowledged 1 – Acknowledged
Alarm acknowledge state 2	2	1	Simple	Unsigned 8	1	D	R/W	Unacknowledged	
Alarm acknowledge state 3	2	2	Simple	Unsigned 8	1	D	R/W	Unacknowledged	
Alarm acknowledge state 4	2	3	Simple	Unsigned 8	1	D	R/W	Unacknowledged	
Alarm acknowledge state 5	2	4	Simple	Unsigned 8	1	D	R/W	Unacknowledged	
Alarm acknowledge state 6	2	5	Simple	Unsigned 8	1	D	R/W	Unacknowledged	
Alarm acknowledge state 7	2	6	Simple	Unsigned 8	1	D	R/W	Unacknowledged	
Alarm acknowledge state 8	2	7	Simple	Unsigned 8	1	D	R/W	Unacknowledged	
Acknowledge alarm 1	2	8	Simple	Unsigned 8	1	D	R/W	Unacknowledged	
Acknowledge alarm 2	2	9	Simple	Unsigned 8	1	D	R/W	Unacknowledged	
Acknowledge alarm 3	2	10	Simple	Unsigned 8	1	D	R/W	Unacknowledged	
Acknowledge alarm 4	2	11	Simple	Unsigned 8	1	D	R/W	Unacknowledged	
Acknowledge alarm 5	2	12	Simple	Unsigned 8	1	D	R/W	Unacknowledged	
Acknowledge alarm 6	2	13	Simple	Unsigned 8	1	D	R/W	Unacknowledged	
Acknowledge alarm 7	2	14	Simple	Unsigned 8	1	D	R/W	Unacknowledged	
Acknowledge alarm 8	2	15	Simple	Unsigned 8	1	D	R/W	Unacknowledged	

A.3.2 Slot 2 – Calibration Clear

Description	Slot	Index	Object type	Data type	Bytes	Store	Access	Default	Valid range
Clear S1 TSS Average	2	16	Simple	Unsigned 8	1	D	R/W	No	0 – No 1 – Yes
Clear S2 TSS Average	2	17	Simple	Unsigned 8	1	D	R/W	No	
Clear S3 TSS Average	2	18	Simple	Unsigned 8	1	D	R/W	No	
Clear S4 TSS Average	2	19	Simple	Unsigned 8	1	D	R/W	No	

A.4 Read-only float

A.4.1 Slot 3 – measured values and ranges

Description	Slot	Index	Object type	Data type	Bytes	Store	Access	Notes	
Sensor 1 – Concentration	3	0	Simple	Float	4	D	R	See engineering ranges (Section A.14, page 39)	
Sensor 1 – Temperature	3	1	Simple	Float	4	D	R		
Sensor 2 – Concentration	3	2	Simple	Float	4	D	R		
Sensor 2 – Temperature	3	3	Simple	Float	4	D	R		
Sensor 3 – Concentration	3	4	Simple	Float	4	D	R		
Sensor 3 – Temperature	3	5	Simple	Float	4	D	R		
Sensor 4 – Concentration	3	6	Simple	Float	4	D	R		
Sensor 4 – Temperature	3	7	Simple	Float	4	D	R		
Conc. Eng. Range High S1	3	8	Simple	Float	4	D	R	engHigh engLow	
Conc. Eng. Range Low S1	3	9	Simple	Float	4	D	R		
Temp. Eng. Range High S1	3	10	Simple	Float	4	D	R		
Temp. Eng. Range Low S1	3	11	Simple	Float	4	D	R		
Conc. Eng. Range High S2	3	12	Simple	Float	4	D	R		
Conc. Eng. Range Low S2	3	13	Simple	Float	4	D	R		
Temp. Eng. Range High S2	3	14	Simple	Float	4	D	R		
Temp. Eng. Range Low S2	3	15	Simple	Float	4	D	R		
Conc. Eng. Range High S3	3	16	Simple	Float	4	D	R		
Conc. Eng. Range Low S3	3	17	Simple	Float	4	D	R		
Temp. Eng. Range High S3	3	18	Simple	Float	4	D	R		
Temp. Eng. Range Low S3	3	19	Simple	Float	4	D	R		
Conc. Eng. Range High S4	3	20	Simple	Float	4	D	R		
Conc. Eng. Range Low S4	3	21	Simple	Float	4	D	R		
Temp. Eng. Range High S4	3	22	Simple	Float	4	D	R		
Temp. Eng. Range Low S4	3	23	Simple	Float	4	D	R		
Sensor 1 – Signal View 1	3	24	Simple	Float	4	D	R		Single Stream – Sensor 1
Sensor 1 – Signal View 2	3	25	Simple	Float	4	D	R		
Sensor 1 – Signal View 3	3	26	Simple	Float	4	D	R		
Sensor 1 – Signal View 4	3	27	Simple	Float	4	D	R		
Sensor 1 – Signal View 5	3	28	Simple	Float	4	D	R		
Sensor 1 – Signal View 6	3	29	Simple	Float	4	D	R		
Sensor 1 – Signal View 7	3	30	Simple	Float	4	D	R		
Sensor 1 – Signal View 8	3	31	Simple	Float	4	D	R		
Sensor 2 – Signal View 1	3	32	Simple	Float	4	D	R	Single Stream – Sensor 2	
Sensor 2 – Signal View 2	3	33	Simple	Float	4	D	R		
Sensor 2 – Signal View 3	3	34	Simple	Float	4	D	R		
Sensor 2 – Signal View 4	3	35	Simple	Float	4	D	R		
Sensor 2 – Signal View 5	3	36	Simple	Float	4	D	R		
Sensor 2 – Signal View 6	3	37	Simple	Float	4	D	R		
Sensor 2 – Signal View 7	3	38	Simple	Float	4	D	R		
Sensor 2 – Signal View 8	3	39	Simple	Float	4	D	R		
Sensor 3 – Signal View 1	3	40	Simple	Float	4	D	R	Single Stream – Sensor 3	
Sensor 3 – Signal View 2	3	41	Simple	Float	4	D	R		
Sensor 3 – Signal View 3	3	42	Simple	Float	4	D	R		
Sensor 3 – Signal View 4	3	43	Simple	Float	4	D	R		
Sensor 3 – Signal View 5	3	44	Simple	Float	4	D	R		
Sensor 3 – Signal View 6	3	45	Simple	Float	4	D	R		
Sensor 3 – Signal View 7	3	46	Simple	Float	4	D	R		
Sensor 3 – Signal View 8	3	47	Simple	Float	4	D	R		

Description	Slot	Index	Object type	Data type	Bytes	Store	Access	Notes
Sensor 4 – Signal View 1	3	48	Simple	Float	4	D	R	Single Stream – Sensor 4
Sensor 4 – Signal View 2	3	49	Simple	Float	4	D	R	
Sensor 4 – Signal View 3	3	50	Simple	Float	4	D	R	
Sensor 4 – Signal View 4	3	51	Simple	Float	4	D	R	
Sensor 4 – Signal View 5	3	52	Simple	Float	4	D	R	
Sensor 4 – Signal View 6	3	53	Simple	Float	4	D	R	
Sensor 4 – Signal View 7	3	54	Simple	Float	4	D	R	
Sensor 4 – Signal View 8	3	55	Simple	Float	4	D	R	
Analog Output 1 – mA Value	3	56	Simple	Float	4	D	R	Analog output value (mA) AOUT1
Analog Output 2 – mA Value	3	57	Simple	Float	4	D	R	Analog output value (mA) AOUT2
Analog Output 3 – mA Value	3	58	Simple	Float	4	D	R	Analog output value (mA) AOUT3
Analog Output 4 – mA Value	3	59	Simple	Float	4	D	R	Analog output value (mA) AOUT4
Analog Output 1 – % of Range	3	60	Simple	Float	4	D	R	Analog output % of full scale AOUT1
Analog Output 2 – % of Range	3	61	Simple	Float	4	D	R	Analog output % of full scale AOUT2
Analog Output 3 – % of Range	3	62	Simple	Float	4	D	R	Analog output % of full scale AOUT3
Analog Output 4 – % of Range	3	63	Simple	Float	4	D	R	Analog output % of full scale AOUT4
RDO Current Calibration Slope S1	3	64	Simple	Float	4	C	R	Current calibration slope S1 (RDO only)
RDO Current Calibration Slope S2	3	65	Simple	Float	4	C	R	Current calibration slope S2 (RDO only)
RDO Current Calibration Slope S3	3	66	Simple	Float	4	C	R	Current calibration slope S1 (RDO only)
RDO Current Calibration Slope S4	3	67	Simple	Float	4	C	R	Current calibration slope S2 (RDO only)
RDO Current Calibration Offset S1	3	68	Simple	Float	4	C	R	Current calibration offset S1 (RDO only)
RDO Current Calibration Offset S2	3	69	Simple	Float	4	C	R	Current calibration offset S2 (RDO only)
RDO Current Calibration Offset S3	3	70	Simple	Float	4	C	R	Current calibration offset S3 (RDO only)
RDO Current Calibration Offset S4	3	71	Simple	Float	4	C	R	Current calibration offset S4 (RDO only)

A.5 Device Info

A.5.1 Slot 4

Description	Slot	Index	Object type	Data type	Bytes	Store	Access	Notes
Transmitter – Date of Manufacture	4	0	Simple	Unsigned 32	4	D	R	Number of seconds since January 1 st 2000
Sensor 1 – Date of Manufacture	4	1	Simple	Unsigned 32	4	D	R	
Sensor 2 – Date of Manufacture	4	2	Simple	Unsigned 32	4	D	R	
Sensor 3 – Date of Manufacture	4	3	Simple	Unsigned 32	4	D	R	
Sensor 4 – Date of Manufacture	4	4	Simple	Unsigned 32	4	D	R	
Sensor 1 – Cap Expiry Date (RDO only)	4	5	Simple	Unsigned 32	4	D	R	
Sensor 2 – Cap Expiry Date (RDO only)	4	6	Simple	Unsigned 32	4	D	R	
Sensor 3 – Cap Expiry Date (RDO only)	4	7	Simple	Unsigned 32	4	D	R	
Sensor 4 – Cap Expiry Date (RDO only)	4	8	Simple	Unsigned 32	4	D	R	

A.6 Device Info

A.6.1 Slot 5

Description	Slot	Index	Object type	Data type	Bytes	Store	Access	Default	Valid range
Sensor 1 – Hardware Version Number	5	0	Simple	Unsigned 16	2	D	R	Current hardware version	1 to 9
Sensor 2 – Hardware Version Number	5	1	Simple	Unsigned 16	2	D	R		
Sensor 3 – Hardware Version Number	5	2	Simple	Unsigned 16	2	D	R		
Sensor 4 – Hardware Version Number	5	3	Simple	Unsigned 16	2	D	R		

A.7 Device Info

A.7.1 Slot 6

Description	Slot	Index	Object type	Data type	Bytes	Store	Access	Default	Valid range
Sensor 1 – Type	6	0	Simple	Unsigned 8	1	D	R	Unrecognized	0 – Unrecognized
Sensor 2 – Type	6	1	Simple	Unsigned 8	1	D	R		10 – 2e_conductivity
Sensor 3 – Type	6	2	Simple	Unsigned 8	1	D	R		20 – Toroidal
Sensor 4 – Type	6	3	Simple	Unsigned 8	1	D	R		30 – 4e_conductivity
									42 – RDO
Media Card Hardware Version Number	6	4	Simple	Unsigned 8	1	D	R		60 – pH 70 – Turbidity IR Low 71 – Turbidity IR High 72 – Turbidity SS Plastic 73 – Turbidity SS Plastic Wiper 75 – Turbidity WL 76 – Turbidity WL High 72 – Turbidity SS Stainless 73 – Turbidity SS Stainless Wiper 80 – Low Level Dissolved Oxygen 255 – No Sensor Fitted

A.8 Device Info

A.8.1 Slot 7

Description	Slot	Index	Object type	Data type	Bytes	Store	Access	Default	Valid range
Transmitter Software Revision Number	7	0	Simple	Visible String	19	C	R	Current Revision	ASCII String
Transmitter Serial Number	7	1	Simple	Visible String	14	C	R	Device Serial Number	
Sensor 1 Software Revision Number	7	2	Simple	Visible String	19	C	R	Current Revision	
Sensor 1 Serial Number	7	3	Simple	Visible String	14	C	R	Device Serial Number	
Sensor 2 Software Revision Number	7	4	Simple	Visible String	19	C	R	Current Revision	
Sensor 2 Serial Number	7	5	Simple	Visible String	14	C	R	Device Serial Number	
Sensor 3 Software Revision Number	7	6	Simple	Visible String	19	C	R	Current Revision	
Sensor 3 Serial Number	7	7	Simple	Visible String	14	C	R	Device Serial Number	
Sensor 4 Software Revision Number	7	8	Simple	Visible String	19	C	R	Current Revision	
Sensor 4 Serial Number	7	9	Simple	Visible String	14	C	R	Device Serial Number	
Sensor 1 Cap Serial Number (RDO only)	7	10	Simple	Visible String	15	C	R	Cap Serial Number	
Sensor 2 Cap Serial Number (RDO only)	7	11	Simple	Visible String	15	C	R	Cap Serial Number	
Sensor 3 Cap Serial Number (RDO only)	7	12	Simple	Visible String	15	C	R	Cap Serial Number	
Sensor 4 Cap Serial Number (RDO only)	7	13	Simple	Visible String	15	C	R	Cap Serial Number	
Media Card Software Version Number	7	14	Simple	Visible String	19	C	R	Current Revision	

A.9 Configuration

A.9.1 Slot 8

Description	Slot	Index	Object type	Data type	Bytes	Store	Access	Default	Valid range	Notes
Chart – Trace 1 – Range High	8	0	Simple	Float	4	D	R/W		Engineering Low to Engineering High	See engineering ranges (Section A.14, page 39)
Chart – Trace 1 – Range Low	8	1	Simple	Float	4	D	R/W			
Chart – Trace 2 – Range High	8	2	Simple	Float	4	D	R/W			
Chart – Trace 2 – Range Low	8	3	Simple	Float	4	D	R/W			
Chart – Trace 3 – Range High	8	4	Simple	Float	4	D	R/W			
Chart – Trace 3 – Range Low	8	5	Simple	Float	4	D	R/W			
Chart – Trace 4 – Range High	8	6	Simple	Float	4	D	R/W			
Chart – Trace 4 – Range Low	8	7	Simple	Float	4	D	R/W			
Sensor 1 – FTU mgl Coefficient (Turbidity only)	8	8	Simple	Float	4	D	R/W		Engineering Low to Engineering High	
Sensor 2 – FTU mgl Coefficient (Turbidity only)	8	9	Simple	Float	4	D	R/W			
Sensor 3 – FTU mgl Coefficient (Turbidity only)	8	10	Simple	Float	4	D	R/W			
Sensor 4 – FTU mgl Coefficient (Turbidity only)	8	11	Simple	Float	4	D	R/W			
Alarm 1 – Trip Point	8	12	Simple	Float	4	D	R/W			
Alarm 2 – Trip Point	8	13	Simple	Float	4	D	R/W			
Alarm 3 – Trip Point	8	14	Simple	Float	4	D	R/W			
Alarm 4 – Trip Point	8	15	Simple	Float	4	D	R/W			
Alarm 5 – Trip Point	8	16	Simple	Float	4	D	R/W			
Alarm 6 – Trip Point	8	17	Simple	Float	4	D	R/W			
Alarm 7 – Trip Point	8	18	Simple	Float	4	D	R/W			
Alarm 8 – Trip Point	8	19	Simple	Float	4	D	R/W			
Alarm 1 – Hysteresis	8	20	Simple	Float	4	D	R/W			
Alarm 2 – Hysteresis	8	21	Simple	Float	4	D	R/W			
Alarm 3 – Hysteresis	8	22	Simple	Float	4	D	R/W			
Alarm 4 – Hysteresis	8	23	Simple	Float	4	D	R/W			
Alarm 5 – Hysteresis	8	24	Simple	Float	4	D	R/W			
Alarm 6 – Hysteresis	8	25	Simple	Float	4	D	R/W			
Alarm 7 – Hysteresis	8	26	Simple	Float	4	D	R/W			
Alarm 8 – Hysteresis	8	27	Simple	Float	4	D	R/W			
Analog Output 1 – Electrical Range High	8	28	Simple	Float	4	D	R/W	20 mA	0 to 22 mA	
Analog Output 1 – Electrical Range Low	8	29	Simple	Float	4	D	R/W	4 mA		
Analog Output 1 – Engineering Range High	8	30	Simple	Float	4	D	R/W		Engineering Low to Engineering High	See engineering ranges (Section A.14, page 39)
Analog Output 1 – Engineering Range Low	8	31	Simple	Float	4	D	R/W			
Analog Output 2 – Electrical Range High	8	32	Simple	Float	4	D	R/W	20 mA	0 to 22 mA	
Analog Output 2 – Electrical Range Low	8	33	Simple	Float	4	D	R/W	4 mA		
Analog Output 2 – Engineering Range High	8	34	Simple	Float	4	D	R/W		Engineering Low to Engineering High	See engineering ranges (Section A.14, page 39)
Analog Output 2 – Engineering Range Low	8	35	Simple	Float	4	D	R/W			
Analog Output 3 – Electrical Range High	8	36	Simple	Float	4	D	R/W	20 mA	0 to 22 mA	
Analog Output 3 – Electrical Range Low	8	37	Simple	Float	4	D	R/W	4 mA		

Description	Slot	Index	Object type	Data type	Bytes	Store	Access	Default	Valid range	Notes
Analog Output 3 – Engineering Range High	8	38	Simple	Float	4	D	R/W		Engineering Low to Engineering High	See engineering ranges (Section A.14, page 39)
Analog Output 3 – Engineering Range Low	8	39	Simple	Float	4	D	R/W			
Analog Output 4 – Electrical Range High	8	40	Simple	Float	4	D	R/W	20 mA	0 to 22 mA	
Analog Output 4 – Electrical Range Low	8	41	Simple	Float	4	D	R/W	4 mA		
Analog Output 4 – Engineering Range High	8	42	Simple	Float	4	D	R/W		Engineering Low to Engineering High	See engineering ranges (Section A.14, page 39)
Analog Output 4 – Engineering Range Low	8	43	Simple	Float	4	D	R/W			
Analog Output 1 – Failure Current	8	44	Simple	Float	4	D	R/W	22 mA	0 to 22 mA	
Analog Output 2 – Failure Current	8	45	Simple	Float	4	D	R/W			
Analog Output 3 – Failure Current	8	46	Simple	Float	4	D	R/W			
Analog Output 4 – Failure Current	8	47	Simple	Float	4	D	R/W			
Sensor 1 Calibration Salinity Correction (RDO only)	8	48	Simple	Float	4	D	R/W	0	0 to 42 PSU	
Sensor 2 Calibration Salinity Correction (RDO only)	8	49	Simple	Float	4	D	R/W			
Sensor 3 Calibration Salinity Correction (RDO only)	8	50	Simple	Float	4	D	R/W			
Sensor 4 Calibration Salinity Correction (RDO only)	8	51	Simple	Float	4	D	R/W			
Sensor 1 Calibration Pressure Correction (RDO only)	8	52	Simple	Float	4	D	R/W	1013.25	507 to 1113 mbar	
Sensor 2 Calibration Pressure Correction (RDO only)	8	53	Simple	Float	4	D	R/W			
Sensor 3 Calibration Pressure Correction (RDO only)	8	54	Simple	Float	4	D	R/W			
Sensor 4 Calibration Pressure Correction (RDO only)	8	55	Simple	Float	4	D	R/W			

A.10 Configuration

A.10.1 Slot 9

Description	Slot	Index	Object type	Data type	Bytes	Store	Access	Default	Valid range
Alarm 1 – Time Hysteresis	9	0	Simple	Unsigned 16	2	D	R/W	0	0 to 9999 seconds
Alarm 2 – Time Hysteresis	9	1	Simple	Unsigned 16	2	D	R/W	0	
Alarm 3 – Time Hysteresis	9	2	Simple	Unsigned 16	2	D	R/W	0	
Alarm 4 – Time Hysteresis	9	3	Simple	Unsigned 16	2	D	R/W	0	
Alarm 5 – Time Hysteresis	9	4	Simple	Unsigned 16	2	D	R/W	0	
Alarm 6 – Time Hysteresis	9	5	Simple	Unsigned 16	2	D	R/W	0	
Alarm 7 – Time Hysteresis	9	6	Simple	Unsigned 16	2	D	R/W	0	
Alarm 8 – Time Hysteresis	9	7	Simple	Unsigned 16	2	D	R/W	0	
Signal 1 – Units	9	8	Simple	Unsigned 16	2	D	R/W	0	See Profibus units – Table A. 15, page 38
Signal 2 – Units	9	9	Simple	Unsigned 16	2	D	R/W	0	
Signal 3 – Units	9	10	Simple	Unsigned 16	2	D	R/W	0	
Signal 4 – Units	9	11	Simple	Unsigned 16	2	D	R/W	0	
Signal 5 – Units	9	12	Simple	Unsigned 16	2	D	R/W	0	
Signal 6 – Units	9	13	Simple	Unsigned 16	2	D	R/W	0	
Signal 7 – Units	9	14	Simple	Unsigned 16	2	D	R/W	0	
Signal 8 – Units	9	15	Simple	Unsigned 16	2	D	R/W	0	

A.11 Configuration

A.11.1 Slot 10

Description	Slot	Index	Object type	Data type	Bytes	Store	Access	Default	Valid range	Notes
Transmitter – Temperature Units (RDO only)	10	0	Simple	Unsigned 8	1	D	R/W	Deg.C	13 or 14	13 – Deg.C 14 – Deg. F
Calibration Salinity Correction Units (RDO only)	10	1	Simple	Unsigned 8	2	D	R/W	PSU	30 or 31	30 – PSU 31 – ppt
Calibration Pressure Correction Units (RDO only)	10	2	Simple	Unsigned 8	3	D	R/W	millibar	32 or 33	32 – millibar 33 – mmHg
Sensor 1 – Dissolved Oxygen Units (RDO only)	10	3	Simple	Unsigned 8	4	D	R/W	ppm	5 or 6	5 – ppm 6 – mg/l
Sensor 2 – Dissolved Oxygen Units (RDO only)	10	4	Simple	Unsigned 8	5	D	R/W			
Sensor 3 – Dissolved Oxygen Units (RDO only)	10	5	Simple	Unsigned 8	6	D	R/W			
Sensor 4 – Dissolved Oxygen Units (RDO only)	10	6	Simple	Unsigned 8	7	D	R/W			
Sensor 1 – Filter Type	10	7	Simple	Unsigned 8	1	D	R/W	Off	0 to 4	0 – Off 1 – Minimum value 2 – Maximum value 3 – Average value 4 – Sliding average
Sensor 1 – Flow Measurement (Turbidity only)	10	8	Simple	Unsigned 8	1	D	R/W	Disabled	0 or 1	0 – Disabled 1 – Enabled
Sensor 2 – Filter Type	10	9	Simple	Unsigned 8	1	D	R/W	Off	0 to 4	0 – Off 1 – Minimum value 2 – Maximum value 3 – Average value 4 – Sliding average
Sensor 2 – Flow Measurement (Turbidity only)	10	10	Simple	Unsigned 8	1	D	R/W	Disabled	0 or 1	0 – Disabled 1 – Enabled
Sensor 3 – Filter Type	10	11	Simple	Unsigned 8	1	D	R/W	Off	0 to 4	0 – Off 1 – Minimum value 2 – Maximum value 3 – Average value 4 – Sliding average
Sensor 3 – Flow Measurement (Turbidity only)	10	12	Simple	Unsigned 8	1	D	R/W	Disabled	0 or 1	0 – Disabled 1 – Enabled
Sensor 4 – Filter Type	10	13	Simple	Unsigned 8	1	D	R/W	Off	0 to 4	0 – Off 1 – Minimum value 2 – Maximum value 3 – Average value 4 – Sliding average
Sensor 4 – Flow Measurement (Turbidity only)	10	14	Simple	Unsigned 8	1	D	R/W	Disabled	0 or 1	0 – Disabled 1 – Enabled

Continued ...

Description	Slot	Index	Object type	Data type	Bytes	Store	Access	Default	Valid range	Notes
Sensor 1 – PV Signal Resolution	10	15	Simple	Unsigned 8	1	D	R/W	0	0 or 1	0 – PV_RESOLUTION_DEFAULT 1 – PV_RESOLUTION_HIGH
Sensor 2 – PV Signal Resolution	10	16	Simple	Unsigned 8	1	D	R/W			
Sensor 3 – PV Signal Resolution	10	17	Simple	Unsigned 8	1	D	R/W			
Sensor 4 – PV Signal Resolution	10	18	Simple	Unsigned 8	1	D	R/W			
Sensor 1 – Clean Frequency	10	19	Simple	Unsigned 8	1	0	R/W	1_hour	0 to 3, or 4 to 96 in increments of 4	0 – off 1 – 15_mins 2 – 30_mins 3 – 45_mins 4 – 1_hour 8 – 2_hours 12 – 3_hours 16 – 4_hours 20 – 5_hours 24 – 6_hours 28 – 7_hours 32 – 8_hours 36 – 9_hours 40 – 10_hours 44 – 11_hours 48 – 12_hours 52 – 13_hours 56 – 14_hours 60 – 15_hours 64 – 16_hours 68 – 17_hours 72 – 18_hours 76 – 19_hours 80 – 20_hours 84 – 21_hours 88 – 22_hours 92 – 23_hours 96 – 24_hours
Sensor 2 – Clean Frequency	10	20	Simple	Unsigned 8	1	D	R/W			
Sensor 3 – Clean Frequency	10	21	Simple	Unsigned 8	1	D	R/W			
Sensor 4 – Clean Frequency	10	22	Simple	Unsigned 8	1	D	R/W			
Sensor 1 – Clean Type	10	23	Simple	Unsigned 8	1	D	R/W	Continuous	0 to 1	0 – Continuous 1 – Pulsed
Sensor 2 – Clean Type	10	24	Simple	Unsigned 8	1	D	R/W			
Sensor 3 – Clean Type	10	25	Simple	Unsigned 8	1	D	R/W			
Sensor 4 – Clean Type	10	26	Simple	Unsigned 8	1	D	R/W			
Sensor 1 – Clean On Time	10	27	Simple	Unsigned 8	1	D	R/W	30	1 to 60	
Sensor 2 – Clean On Time	10	28	Simple	Unsigned 8	1	D	R/W			
Sensor 3 – Clean On Time	10	29	Simple	Unsigned 8	1	D	R/W			
Sensor 4 – Clean On Time	10	30	Simple	Unsigned 8	1	D	R/W			

Continued ...

Description	Slot	Index	Object type	Data type	Bytes	Store	Access	Default	Valid range	Notes
Sensor 1 – Clean Off Time	10	31	Simple	Unsigned 8	1	D	R/W	30	1 to 60	
Sensor 2 – Clean Off Time	10	32	Simple	Unsigned 8	1	D	R/W			
Sensor 3 – Clean Off Time	10	33	Simple	Unsigned 8	1	D	R/W			
Sensor 4 – Clean Off Time	10	34	Simple	Unsigned 8	1	D	R/W			
Sensor 1 – Clean Pulses	10	35	Simple	Unsigned 8	1	D	R/W	2 pulses	0 to 9	0 – 1 pulse 1 – 2 pulses
Sensor 2 – Clean Pulses	10	36	Simple	Unsigned 8	1	D	R/W			2 – 3 pulses 3 – 4 pulses
Sensor 3 – Clean Pulses	10	37	Simple	Unsigned 8	1	D	R/W			4 – 5 pulses 5 – 6 pulses
Sensor 4 – Clean Pulses	10	38	Simple	Unsigned 8	1	D	R/W			6 – 7 pulses 7 – 8 pulses 8 – 9 pulses 9 – 10 pulses
Sensor 1 – Clean Recovery Time	10	39	Simple	Unsigned 8	1	D	R/W	1 min	0 to 9	0 – 1 min 1 – 2 min
Sensor 2 – Clean Recovery Time	10	40	Simple	Unsigned 8	1	D	R/W			2 – 3 min 3 – 4 min
Sensor 3 – Clean Recovery Time	10	41	Simple	Unsigned 8	1	D	R/W			4 – 5 min 5 – 6 min
Sensor 4 – Clean Recovery Time	10	42	Simple	Unsigned 8	1	D	R/W			6 – 7 min 7 – 8 min 8 – 9 min 9 – 10 min
Sensor 1 – Clean Assignment	10	43	Simple	Unsigned 8	1	D	R/W	None	0 to 12	0 – None 1 – Relay 1
Sensor 2 – Clean Assignment	10	44	Simple	Unsigned 8	1	D	R/W			2 – Relay 2 3 – Relay 3
Sensor 3 – Clean Assignment	10	45	Simple	Unsigned 8	1	D	R/W			4 – Relay 4 5 – Relay 5
Sensor 4 – Clean Assignment	10	46	Simple	Unsigned 8	1	D	R/W			6 – Relay 6 7 – DIO 1 8 – DIO 2 9 – DIO 3 10 – DIO 4 11 – DIO 5 12 – DIO 6
Sensor 1 – Hold	10	47	Simple	Unsigned 8	1	D	R/W	No Hold	0 or 1	0 – No Hold 1 – Hold
Sensor 2 – Hold	10	48	Simple	Unsigned 8	1	D	R/W			
Sensor 3 – Hold	10	49	Simple	Unsigned 8	1	D	R/W			
Sensor 4 – Hold	10	50	Simple	Unsigned 8	1	D	R/W			
Operator Page 2 Template	10	51	Simple	Unsigned 8	1	D	R/W	Off	0 to 4	0 – Off 1 – Sensor 1
Operator Page 3 Template	10	52	Simple	Unsigned 8	1	D	R/W			2 – Sensor 2 3 – Sensor 3
Operator Page 4 Template	10	53	Simple	Unsigned 8	1	D	R/W			4 – Sensor 4
Operator Page 5 Template	10	54	Simple	Unsigned 8	1	D	R/W			

Continued ...

Description	Slot	Index	Object type	Data type	Bytes	Store	Access	Default	Valid range	Notes
Diagnostics View	10	55	Simple	Unsigned 8	1	D	R/W	Enabled	0 or 1	0 – Disabled 1 – Enabled
Signals View	10	56	Simple	Unsigned 8	1	D	R/W			
Chart View	10	57	Simple	Unsigned 8	1	D	R/W	Disabled		
Alarm View	10	58	Simple	Unsigned 8	1	D	R/W			
Analog Output View	10	59	Simple	Unsigned 8	1	D	R/W			
Calibration Log	10	60	Simple	Unsigned 8	1	D	R/W			
Alarm Log	10	61	Simple	Unsigned 8	1	D	R/W			
Audit Log	10	62	Simple	Unsigned 8	1	D	R/W			
Diagnostics Log	10	63	Simple	Unsigned 8	1	D	R/W			
Date Format	10	64	Simple	Unsigned 8	1	D	R/W	yyyy/mm/dd	0 to 2	0 – dd/mm/yyyy 1 – mm/dd/yyyy 2 – yyyy/mm/dd
Daylight Saving – Region	10	65	Simple	Unsigned 8	1	D	R/W	Off	0 to 3	0 – Daylight Saving is Off 1 – Europe 2 – USA 3 – Custom
Daylight Saving – Start Hour for Daylight Saving	10	66	Simple	Unsigned 8	1	D	R/W	1	0 to 23	
Daylight Saving – Start Occurance for Daylight Saving	10	67	Simple	Unsigned 8	1	D	R/W	Last	1 to 5	1 – First 2 – Second 3 – Third 4 – Fourth 5 – Last
Daylight Saving – Start Day for Daylight Saving	10	68	Simple	Unsigned 8	1	D	R/W	Sunday	1 to 7	1 – Sunday 2 – Monday 3 – Tuesday 4 – Wednesday 5 – Thursday 6 – Friday 7 – Saturday
Daylight Saving – Start Month for Daylight Saving	10	69	Simple	Unsigned 8	1	D	R/W	March	1 to 12	1 – January 2 – February 3 – March 4 – April 5 – May 6 – June 7 – July 8 – August 9 – September 10 – October 11 – November 12 – December
Daylight Saving – End Hour for Daylight Saving	10	70	Simple	Unsigned 8	1	D	R/W	1	0 to 23	
Daylight Saving – End Occurance for Daylight Saving	10	71	Simple	Unsigned 8	1	D	R/W	Last	1 to 5	1 – First 2 – Second 3 – Third 4 – Fourth 5 – Last

Continued ...

Description	Slot	Index	Object type	Data type	Bytes	Store	Access	Default	Valid range	Notes
Daylight Saving – End Day for Daylight Saving	10	72	Simple	Unsigned 8	1	D	R/W	Sunday	1 to 7	1 – Sunday 2 – Monday 3 – Tuesday 4 – Wednesday 5 – Thursday 6 – Friday 7 – Saturday
Daylight Saving – End Month for Daylight Saving	10	73	Simple	Unsigned 8	1	D	R/W	October	1 to 12	1 – January 2 – February 3 – March 4 – April 5 – May 6 – June 7 – July 8 – August 9 – September 10 – October 11 – November 12 – December
Alarm 1 – Type	10	74	Simple	Unsigned 8	1	D	R/W	Off	0 to 4	0 – Off 1 – High process 2 – Low process 3 – High latch 4 – Low latch
Alarm 1 – Source	10	75	Simple	Unsigned 8	1	D	R/W	None	0 to 8	See signal source list (Section A.13, page 38)
Alarm 2 – Type	10	76	Simple	Unsigned 8	1	D	R/W	High process	0 to 4	0 – Off 1 – High process 2 – Low process 3 – High latch 4 – Low latch
Alarm 2 – Source	10	77	Simple	Unsigned 8	1	D	R/W	None	0 to 8	See signal source list (Section A.13, page 38)
Alarm 3 – Type	10	78	Simple	Unsigned 8	1	D	R/W	High process	0 to 4	0 – Off 1 – High process 2 – Low process 3 – High latch 4 – Low latch
Alarm 3 – Source	10	79	Simple	Unsigned 8	1	D	R/W	None	0 to 8	See signal source list (Section A.13, page 38)
Alarm 4 – Type	10	80	Simple	Unsigned 8	1	D	R/W	High process	0 to 4	0 – Off 1 – High process 2 – Low process 3 – High latch 4 – Low latch
Alarm 4 – Source	10	81	Simple	Unsigned 8	1	D	R/W	None	0 to 8	See signal source list (Section A.13, page 38)
Alarm 5 – Type	10	82	Simple	Unsigned 8	1	D	R/W	High process	0 to 4	0 – Off 1 – High process 2 – Low process 3 – High latch 4 – Low latch
Alarm 5 – Source	10	83	Simple	Unsigned 8	1	D	R/W	None	0 to 8	See signal source list (Section A.13, page 38)

Continued ...

Description	Slot	Index	Object type	Data type	Bytes	Store	Access	Default	Valid range	Notes
Alarm 6 – Type	10	84	Simple	Unsigned 8	1	D	R/W	High process	0 to 4	0 – Off 1 – High process 2 – Low process 3 – High latch 4 – Low latch
Alarm 6 – Source	10	85	Simple	Unsigned 8	1	D	R/W	None	0 – 8	See signal source list (Section A.13, page 38)
Alarm 7 – Type	10	86	Simple	Unsigned 8	1	D	R/W	High process	0 – 4	0 – Off 1 – High process 2 – Low process 3 – High latch 4 – Low latch
Alarm 7 – Source	10	87	Simple	Unsigned 8	1	D	R/W	None	0 to 8	See signal source list (Section A.13, page 38)
Alarm 8 – Type	10	88	Simple	Unsigned 8	1	D	R/W	High process	0 to 4	0 – Off 1 – High process 2 – Low process 3 – High latch 4 – Low latch
Alarm 8 – Source	10	89	Simple	Unsigned 8	1	D	R/W	0	0 to 8	See signal source list (Section A.13, page 38)
Analog Output 1 – Source	10	90	Simple	Unsigned 8	1	D	R/W	0	0 to 8	See source list (Section A.13, page 38)
Analog Output 1 – Output Type	10	91	Simple	Unsigned 8	1	D	R/W	Linear	0 to 3	0 – Linear 1 – Logarithmic (2 decades) 2 – Logarithmic (3 decades) 3 – Logarithmic (4 decades)
Analog Output 1 – Failure Current Enable	10	92	Simple	Unsigned 8	1	D	R/W	0	0 or 1	0 – Enabled 1 – Disabled
Analog Output 2 – Source	10	93	Simple	Unsigned 8	1	D	R/W	0	0 to 8	See signal source list (Section A.13, page 38)
Analog Output 2 – Output Type	10	94	Simple	Unsigned 8	1	D	R/W	Linear	0 to 3	0 – Linear 1 – Logarithmic (2 decades) 2 – Logarithmic (3 decades) 3 – Logarithmic (4 decades)
Analog Output 2 – Failure Current Enable	10	95	Simple	Unsigned 8	1	D	R/W	0	0 or 1	0 – Enabled 1 – Disabled
Analog Output 3 – Source	10	96	Simple	Unsigned 8	1	D	R/W	0	0 to 8	See signal source list (Section A.13, page 38)
Analog Output 3 – Output Type	10	97	Simple	Unsigned 8	1	D	R/W	Linear	0 to 3	0 – Linear 1 – Logarithmic (2 decades) 2 – Logarithmic (3 decades) 3 – Logarithmic (4 decades)
Analog Output 3 – Failure Current Enable	10	98	Simple	Unsigned 8	1	D	R/W	0	0 or 1	0 – Enabled 1 – Disabled

Continued ...

Description	Slot	Index	Object type	Data type	Bytes	Store	Access	Default	Valid range	Notes
Analog Output 4 – Source	10	99	Simple	Unsigned 8	1	D	R/W	0	0 to 8	See source list (Section A.13, page 38)
Analog Output 4 – Output Type	10	100	Simple	Unsigned 8	1	D	R/W	Linear	0 to 3	0 – Linear 1 – Logarithmic (2 decades) 2 – Logarithmic (3 decades) 3 – Logarithmic (4 decades)
Analog Output 4 – Failure Current Enable	10	101	Simple	Unsigned 8	1	D	R/W	Enabled	0 or 1	0 – Enabled 1 – Disabled
Digital I/O 1 – Type	10	102	Simple	Unsigned 8	1	D	R/W	Off	0 to 3	0 – Off 1 – Digital output 2 – Digital input (volt-free) 3 – Digital input (24 V)
Digital I/O 1 – Source	10	103	Simple	Unsigned 8	1	D	R/W	0	0, or 9 to 64	See source list (Section A.13, page 38)
Digital I/O 1 – Polarity	10	104	Simple	Unsigned 8	1	D	R/W	Non inverted	0 or 1	0 – inverted 1 – Non inverted
Digital I/O 2 – Type	10	105	Simple	Unsigned 8	1	D	R/W	Off	0 to 3	0 – Off 1 – Digital output 2 – Digital input (volt-free) 3 – Digital input (24 V)
Digital I/O 2 – Source	10	106	Simple	Unsigned 8	1	D	R/W	None	0 to 8	0 – None 1 – Sensor 1 concentration 2 – Sensor 2 concentration 3 – Sensor 3 concentration 4 – Sensor 4 concentration 5 – Sensor 1 temperature 6 – Sensor 2 temperature 7 – Sensor 3 temperature 8 – Sensor 4 temperature
Digital I/O 2 – Polarity	10	107	Simple	Unsigned 8	1	D	R/W	Non inverted	0 or 1	0 – Inverted 1 – Non inverted
Digital I/O 3 – Type	10	108	Simple	Unsigned 8	1	D	R/W	Off	0 to 3	0 – Off 1 – Digital output 2 – Digital input (volt-free) 3 – Digital input (24 V)
Digital I/O 3 – Source	10	109	Simple	Unsigned 8	1	D	R/W	0	0, or 9 to 64	See source list (Section A.13, page 38)
Digital I/O 3 – Polarity	10	110	Simple	Unsigned 8	1	D	R/W	Non inverted	0 or 1	0 – inverted 1 – Non inverted
Digital I/O 4 – Type	10	111	Simple	Unsigned 8	1	D	R/W	Off	0 to 3	0 – Off 1 – Digital output 2 – Digital input (volt-free) 3 – Digital input (24 V)
Digital I/O 4 – Source	10	112	Simple	Unsigned 8	1	D	R/W	0	0, or 9 to 64	See source list (Section A.13, page 38)
Digital I/O 4 – Polarity	10	113	Simple	Unsigned 8	1	D	R/W	Non inverted	0 or 1	0 – inverted 1 – Non inverted

Continued ...

Description	Slot	Index	Object type	Data type	Bytes	Store	Access	Default	Valid range	Notes
Digital I/O 5 – Type	10	114	Simple	Unsigned 8	1	D	R/W	Off	0 – 3	0 – Off 1 – Digital output 2 – Digital input (volt-free) 3 – Digital input (24 V)
Digital I/O 5 – Source	10	115	Simple	Unsigned 8	1	D	R/W	0	0, or 9 to 64	See source list (Section A.13, page 38)
Digital I/O 5 – Polarity	10	116	Simple	Unsigned 8	1	D	R/W	Non inverted	0 or 1	0 – inverted 1 – Non inverted
Digital I/O 6 – Type	10	117	Simple	Unsigned 8	1	D	R/W	Off	0 – 3	0 – Off 1 – Digital output 2 – Digital input (volt-free) 3 – Digital input (24 V)
Digital I/O 6 – Source	10	118	Simple	Unsigned 8	1	D	R/W	0	0, or 9 to 64	See source list (Section A.13, page 38)
Digital I/O 6 – Polarity	10	119	Simple	Unsigned 8	1	D	R/W	Non inverted	0 or 1	0 – inverted 1 – Non inverted
Relay 1 – Source	10	120	Simple	Unsigned 8	1	D	R/W	0	0, or 9 to 44	
Relay 1 – Polarity	10	121	Simple	Unsigned 8	1	D	R/W	Non inverted	0 or 1	0 – inverted 1 – Non inverted
Relay 2 – Source	10	122	Simple	Unsigned 8	1	D	R/W	0	0, or 9 to 44	
Relay 2 – Polarity	10	123	Simple	Unsigned 8	1	D	R/W	Non inverted	0 or 1	0 – inverted 1 – Non inverted
Relay 3 – Source	10	124	Simple	Unsigned 8	1	D	R/W	0	0, or 9 to 44	
Relay 3 – Polarity	10	125	Simple	Unsigned 8	1	D	R/W	Non inverted	0 or 1	0 – inverted 1 – Non inverted
Relay 4 – Source	10	126	Simple	Unsigned 8	1	D	R/W	0	0, or 9 to 44	
Relay 4 – Polarity	10	127	Simple	Unsigned 8	1	D	R/W	Non inverted	0 or 1	0 – inverted 1 – Non inverted
Relay 5 – Source	10	128	Simple	Unsigned 8	1	D	R/W	0	0, or 9 to 44	
Relay 5 – Polarity	10	129	Simple	Unsigned 8	1	D	R/W	Non inverted	0 or 1	0 – inverted 1 – Non inverted
Relay 6 – Source	10	130	Simple	Unsigned 8	1	D	R/W	0	0, or 9 to 44	
Relay 6 – Polarity	10	131	Simple	Unsigned 8	1	D	R/W	Non inverted	0 or 1	0 – inverted 1 – Non inverted

A.12 Configuration

A.12.1 Slot 11 – tags

Description	Slot	Index	Object type	Data type	Bytes	Store	Access	Default	Valid range
Instrument Tag	11	0	Simple	Visible String	16	C	R/W	Aztec 400	ASCII String
Process Tag 1	11	1	Simple	Visible String	16	C	R/W	Tag 1	
Process Tag 2	11	2	Simple	Visible String	16	C	R/W	Tag 2	
Process Tag 3	11	3	Simple	Visible String	16	C	R/W	Tag 3	
Process Tag 4	11	4	Simple	Visible String	16	C	R/W	Tag 4	
Alarm 1 tag	11	5	Simple	Visible String	16	C	R/W	Alarm 1	
Alarm 2 tag	11	6	Simple	Visible String	16	C	R/W	Alarm 2	
Alarm 3 tag	11	7	Simple	Visible String	16	C	R/W	Alarm 3	
Alarm 4 tag	11	8	Simple	Visible String	16	C	R/W	Alarm 4	
Alarm 5 tag	11	9	Simple	Visible String	16	C	R/W	Alarm 5	
Alarm 6 tag	11	10	Simple	Visible String	16	C	R/W	Alarm 6	
Alarm 7 tag	11	11	Simple	Visible String	16	C	R/W	Alarm 7	
Alarm 8 tag	11	12	Simple	Visible String	16	C	R/W	Alarm 8	
Chart config tag 1	11	13	Simple	Visible String	3	C	R/W	Ch 1	
Chart config tag 2	11	14	Simple	Visible String	3	C	R/W	Ch 2	
Chart config tag 3	11	15	Simple	Visible String	3	C	R/W	Ch 3	
Chart config tag 4	11	16	Simple	Visible String	3	C	R/W	Ch 4	

A.13 Signal source list

Signal value	Source name
0	None
1	anlglP1 – Sensor 1 concentration
2	anlglP2 – Sensor 1 temperature
3	anlglP3 – Sensor 2 concentration
4	anlglP4 – Sensor 2 temperature
5	anlglP5 – Sensor 3 concentration
6	anlglP6 – Sensor 3 temperature
7	anlglP7 – Sensor 4 concentration
8	anlglP8 – Sensor 4 temperature
9	AlarmState1
10	AlarmState2
11	AlarmState3
12	AlarmState4
13	AlarmState5
14	AlarmState6
15	AlarmState7
16	AlarmState8
17	sensor1_fail
18	sensor2_fail
19	sensor3_fail
20	sensor4_fail
21	sensor1_out_of_spec
22	sensor2_out_of_spec
23	sensor3_out_of_spec
24	sensor4_out_of_spec
25	sensor1_maintenance
26	sensor2_maintenance
27	sensor3_maintenance
28	sensor4_maintenance
29	sensor1_function_check

Signal value	Source name
30	sensor2_function_check
31	sensor3_function_check
32	sensor4_function_check
33	transmitter_failure
34	transmitter_out_of_spec
35	transmitter_maintenance
36	transmitter_function_check
37	sensor1_cal_in_progress
38	sensor2_cal_in_progress
39	sensor3_cal_in_progress
40	sensor4_cal_in_progress
41	sensor1_cal_failed
42	sensor2_cal_failed
43	sensor3_cal_failed
44	sensor4_cal_failed
45	sensor1_flow_status
46	sensor2_flow_status
47	sensor3_flow_status
48	sensor4_flow_status
49	sensor1_clean
50	sensor2_clean
51	sensor3_clean
52	sensor4_clean
53	sensor1_hold
54	sensor2_hold
55	sensor3_hold
56	sensor4_hold
57	sensor1_clean_sequence
58	sensor2_clean_sequence
59	sensor3_clean_sequence
60	sensor4_clean_sequence

A.14 Engineering ranges – dissolved oxygen

Source	Range low	Range high	Units
Dissolved oxygen concentration	0	50	mg/l or ppm
Dissolved oxygen percentage	0	200	%
Salinity correction	0	42	PSU or ppt
Barometric pressure correction	507 (380)	1113 (835)	mbar (mmHg)

A.15 Signal view allocations

Signal view allocations	Dissolved oxygen
Sensor 1 – Signal view 1	Cyclic data concentration S1
Sensor 1 – Signal view 2	Cyclic data percentage S1
Sensor 1 – Signal view 3	Cyclic data temperature S1
Sensor 1 – Signal view 4	Calibration slope S1
Sensor 1 – Signal view 5	Calibration offset S1
Sensor 1 – Signal view 6	RDO cap expiry S1 (weeks)
Sensor 1 – Signal view 7	N/A
Sensor 1 – Signal view 8	N/A
Sensor 2 – Signal view 1	Cyclic data concentration S2
Sensor 2 – Signal view 2	Cyclic data percentage S2
Sensor 2 – Signal view 3	Cyclic data temperature S2
Sensor 2 – Signal view 4	Calibration slope S2
Sensor 2 – Signal view 5	Calibration offset S2
Sensor 2 – Signal view 6	RDO cap expiry S2 (weeks)
Sensor 2 – Signal view 7	N/A
Sensor 2 – Signal view 8	N/A
Sensor 3 – Signal view 1	Cyclic data concentration S3
Sensor 3 – Signal view 2	Cyclic data percentage S3
Sensor 3 – Signal view 3	Cyclic data temperature S3
Sensor 3 – Signal view 4	Calibration slope S3
Sensor 3 – Signal view 5	Calibration offset S3
Sensor 3 – Signal view 6	RDO cap expiry S3 (weeks)
Sensor 3 – Signal view 7	N/A
Sensor 3 – Signal view 8	N/A
Sensor 4 – Signal view 1	Cyclic data concentration S4
Sensor 4 – Signal view 2	Cyclic data percentage S4
Sensor 4 – Signal view 3	Cyclic data temperature S4
Sensor 4 – Signal view 4	Calibration slope S4
Sensor 4 – Signal view 5	Calibration offset S4
Sensor 4 – Signal view 6	RDO cap expiry S4 (weeks)
Sensor 4 – Signal view 7	N/A
Sensor 4 – Signal view 8	N/A

A.16 Profibus units

Unit value	Units
1001	°C
1002	°F
1105	g/l
1138	mbar
1157	mmHg
1211	mA
1212	µA
1243	mV
1281	Ω-cm
1283	MΩ-cm
1302	mS/cm
1342	%
1422	pH
1423	ppm
1424	ppb
1425	ppt
1552	µS/cm
1553	mS/M
1554	µS/M
1558	mg/l
1559	µg/l
1563	ml/min
1577	ml/s
1997	(none)
32768	NTU
32768	FNU
32768	FTU
32768	FAU
32772	µg/Kg
32773	mg/Kg
32774	NM ³ /H
32775	BAR A
32776	TDS
32777	% Sat
32778	PSU
32779	weeks
32780	days

Appendix B – MODBUS tables

B.1 Digital inputs

B.1.1 Sensor reading diagnostics

MODBUS address	Description
0	Sensor 1 concentration value status
1	Sensor 1 temperature value status
2	Sensor 2 concentration value status
3	Sensor 2 temperature value status
4	Sensor 3 concentration value status
5	Sensor 3 temperature value status
6	Sensor 4 concentration value status
7	Sensor 4 temperature value status

B.1.2 Transmitter function diagnostics

MODBUS address	Description
8	Transmitter failure diagnostic
9	Transmitter out of specification diagnostic
10	Transmitter maintenance diagnostic
11	Transmitter function check diagnostic

B.1.3 Sensor function diagnostics

MODBUS address	Description
12	Sensor 1 failure diagnostic
13	Sensor 1 out of specification diagnostic
14	Sensor 1 maintenance diagnostic
15	Sensor 1 function check diagnostic
16	Sensor 2 failure diagnostic
17	Sensor 2 out of specification diagnostic
18	Sensor 2 maintenance diagnostic
19	Sensor 2 function check diagnostic
20	Sensor 3 failure diagnostic
21	Sensor 3 out of specification diagnostic
22	Sensor 3 maintenance diagnostic
23	Sensor 3 function check diagnostic
24	Sensor 4 failure diagnostic
25	Sensor 4 out of specification diagnostic
26	Sensor 4 maintenance diagnostic
27	Sensor 4 function check diagnostic

B.1.4 Transmitter diagnostics

MODBUS address	Description
28	Non-volatile memory error process board
29	Non-volatile memory error main board
30	Non-volatile memory error communications board
31	Non-volatile memory error software key 1
32	Internal communications error
33	Excessive sensor current
34	Configuration error
35	Simulation on
36	In manual test
37	In configuration
38	Media card full
39	Media card near full

B.1.5 Sensor 1 (single-stream) diagnostics

MODBUS address	Description
40	Temperature sensor failure
41	ADC failure
42	Non-volatile memory error
43	No sample
44	Calibration in progress
45	Recovery in progress
46	Regeneration in progress
47	In hold mode
48	Last calibration failed
49	Missed schedule calibration
50	Sample temperature is hot
51	Sample temperature is cold
52	Concentration value is out of range
53	Type error
54	No sample
55	No low calibration solution
56	No high calibration solution
57	Cap expired
58	Flow error

B.1.6 Sensor 2 diagnostics

MODBUS address	Description
59	Temperature sensor failure
60	ADC failure
61	Non-volatile memory error
62	No sample
63	Calibration in progress
64	Recovery in progress
65	Regeneration in progress
66	In hold mode
67	Last calibration failed
68	Missed schedule calibration
69	Sample temperature is hot
70	Sample temperature is cold
71	Concentration value is out of range
72	Type error
73	No sample
74	No low calibration solution
75	No high calibration solution
76	Cap expired
77	Flow error

B.1.7 Sensor 3 diagnostics

MODBUS address	Description
78	Temperature sensor failure
79	ADC failure
80	Non-volatile memory error
81	No sample
82	Calibration in progress
83	Recovery in progress
84	Regeneration in progress
85	In hold mode
86	Last calibration failed
87	Missed schedule calibration
88	Sample temperature is hot
89	Sample temperature is cold
90	Concentration value is out of range
91	Type error
92	No sample
93	No low calibration solution
94	No high calibration solution
95	Cap expired
96	Flow error

B.1.8 Sensor 4 diagnostics

MODBUS address	Description
97	Temperature sensor failure
98	ADC failure
99	Non-volatile memory error
100	No sample
101	Calibration in progress
102	Recovery in progress
103	Regeneration in progress
104	In hold mode
105	Last calibration failed
106	Missed schedule calibration
107	Sample temperature is hot
108	Sample temperature is cold
109	Concentration value is out of range
110	Type error
111	No sample
112	No low calibration solution
113	No high calibration solution
114	Cap expired
115	Flow error

B.1.9 Multi-stream sensor diagnostics

MODBUS address	Description
116	Temperature sensor failure
117	ADC failure
118	Non-volatile memory error
119	No sample
120	Calibration in progress
121	Recovery in progress
122	Regeneration in progress
123	In hold mode
124	Last calibration failed
125	Missed schedule calibration
126	Sample temperature is hot
127	Sample temperature is cold
128	Concentration value is out of range
129	No sample stream 1
130	No sample stream 2
131	No sample stream 3
132	No low calibration solution
133	No high calibration solution
134	Cap expired
135	Flow error stream 1
136	Flow error stream 2
137	Flow error stream 3

B.1.10 Relay state diagnostics

MODBUS address	Description
138	Relay 1 state
139	Relay 2 state
140	Relay 3 state
141	Relay 4 state
142	Relay 5 state
143	Relay 6 state
144	Alarm 1 state
145	Alarm 2 state
146	Alarm 3 state
147	Alarm 4 state
148	Alarm 5 state
149	Alarm 6 state
150	Alarm 7 state
151	Alarm 8 state

B.1.11 Digital I/O diagnostics

MODBUS address	Description
152	Digital output 1 state
153	Digital output 2 state
154	Digital output 3 state
155	Digital output 4 state
156	Digital output 5 state
157	Digital output 6 state
158	Digital input 1 state
159	Digital input 2 state
160	Digital input 3 state
161	Digital input 4 state
162	Digital input 5 state
163	Digital input 6 state

B.2 Digital outputs

MODBUS address	Description
0	Alarm 1 acknowledge state
1	Alarm 2 acknowledge state
2	Alarm 3 acknowledge state
3	Alarm 4 acknowledge state
4	Alarm 5 acknowledge state
5	Alarm 6 acknowledge state
6	Alarm 7 acknowledge state
7	Alarm 8 acknowledge state
8	Acknowledge alarm 1
9	Acknowledge alarm 2
10	Acknowledge alarm 3
11	Acknowledge alarm 4
12	Acknowledge alarm 5
13	Acknowledge alarm 6
14	Acknowledge alarm 7
15	Acknowledge alarm 8

B.3 Read-only, single precision float

B.3.1 Measurement values – see engineering ranges table (Section B.12, page 49)

MODBUS address	Description
30000	Sensor 1 – Concentration
30002	Sensor 1 – Temperature
30004	Sensor 2 – Concentration
30006	Sensor 2 – Temperature
30008	Sensor 3 – Concentration
30010	Sensor 3 – Temperature
30012	Sensor 4 – Concentration
30014	Sensor 4 – Temperature

B.3.2 Measurement range limits

MODBUS address	Description
30016	Concentration – Engineering range high S1
30018	Concentration – Engineering range low S1
30020	Temperature – Engineering range high S1
30022	Temperature – Engineering range low S1
30024	Concentration – Engineering range high S2
30026	Concentration – Engineering range low S2
30028	Temperature – Engineering range high S2
30030	Temperature – Engineering range low S2
30032	Concentration – Engineering range high S3
30034	Concentration – Engineering range low S3
30036	Temperature – Engineering range high S3
30038	Temperature – Engineering range low S3
30040	Concentration – Engineering range high S4
30042	Concentration – Engineering range low S4
30044	Temperature – Engineering range high S4
30046	Temperature – Engineering range low S4

B.3.3 Sensor signals view – see signal view allocations table (Section B.12.2, page 49)

MODBUS address	Description
30048	Sensor 1 – Signal view 1
30050	Sensor 1 – Signal view 2
30052	Sensor 1 – Signal view 3
30054	Sensor 1 – Signal view 4
30056	Sensor 1 – Signal view 5
30058	Sensor 1 – Signal view 6
30060	Sensor 1 – Signal view 7
30062	Sensor 1 – Signal view 8
30064	Sensor 2 – Signal view 1
30066	Sensor 2 – Signal view 2
30068	Sensor 2 – Signal view 3
30070	Sensor 2 – Signal view 4
30072	Sensor 2 – Signal view 5
30074	Sensor 2 – Signal view 6
30076	Sensor 2 – Signal view 7
30078	Sensor 2 – Signal view 8
30080	Sensor 3 – Signal view 1
30082	Sensor 3 – Signal view 2
30084	Sensor 3 – Signal view 3
30086	Sensor 3 – Signal view 4
30088	Sensor 3 – Signal view 5
30090	Sensor 3 – Signal view 6
30092	Sensor 3 – Signal view 7
30094	Sensor 3 – Signal view 8
30096	Sensor 4 – Signal view 1
30098	Sensor 4 – Signal view 2
30100	Sensor 4 – Signal view 3
30102	Sensor 4 – Signal view 4
30104	Sensor 4 – Signal view 5
30106	Sensor 4 – Signal view 6
30108	Sensor 4 – Signal view 7
30110	Sensor 4 – Signal view 8

B.3.4 Analog outputs

MODBUS address	Description
30112	Analog output value (mA) AOUT1
30114	Analog output value (mA) AOUT2
30116	Analog output value (mA) AOUT3
30118	Analog output value (mA) AOUT4
30120	Analog output % of full scale AOUT1
30122	Analog output % of full scale AOUT2
30124	Analog output % of full scale AOUT3
30126	Analog output % of full scale AOUT4

B.3.5 Sensor calibration values (RDO only)

MODBUS address	Description
30128	Current calibration slope S1
30130	Current calibration slope S2
30132	Current calibration slope S3
30134	Current calibration slope S4
30136	Current calibration offset S1
30138	Current calibration offset S2
30140	Current calibration offset S3
30142	Current calibration offset S4

B.4 Read only 32 bits

B.4.1 Transmitter date (number of seconds since 01/01/2000)

MODBUS address	Description
31000	Transmitter – Date of manufacture

B.4.2 Sensor dates (number of seconds since 01/01/2000)

MODBUS address	Description
31002	Sensor 1 – Date of manufacture
31004	Sensor 2 – Date of manufacture
31006	Sensor 3 – Date of manufacture
31008	Sensor 4 – Date of manufacture
31010	Sensor 1 – Cap expiry date
31012	Sensor 2 – Cap expiry date
31014	Sensor 3 – Cap expiry date
31016	Sensor 4 – Cap expiry date

B.5 Read only 16 bits – sensor hardware version (valid range 1 to 9)

MODBUS address	Description
32000	Sensor 1 – Hardware version number
32001	Sensor 2 – Hardware version number
32002	Sensor 2 – Hardware version number
32003	Sensor 2 – Hardware version number

B.6 Read-only 8 bits

B.6.1 Sensor type – see sensor type valid range table (Section B.12.3. page 50)

MODBUS address	Description
33000	Sensor 1 – Type
33001	Sensor 2 – Type
33002	Sensor 3 – Type
33003	Sensor 4 – Type

B.6.2 Media card version

MODBUS address	Description
33004	Media card hardware version number

B.7 Read-only strings

MODBUS address	Description	No. of Bytes
34000	Transmitter software revision number	19
34019	Transmitter serial number	14
34033	Sensor 1 software revision number	19
34052	Sensor 1 serial number	14
34066	Sensor 2 software revision number	19
34085	Sensor 2 Serial Number	14
34099	Sensor 3 software revision number	19
34118	Sensor 3 Serial Number	14
34132	Sensor 4 software revision number	19
34151	Sensor 4 serial number	14
34165	Sensor 1 cap serial number	15
34180	Sensor 2 cap serial number	15
34195	Sensor 3 cap serial number	15
34210	Sensor 4 cap serial number	15
34225	Media card software version number	19

B.8 Writable floats

B.8.1 Chart trace range – see engineering ranges table (Section B.12, page 49)

MODBUS address	Description
40000	Chart – Trace 1 – range high
40002	Chart – Trace 1 – range low
40004	Chart – Trace 2 – range high
40006	Chart – Trace 2 – range low
40008	Chart – Trace 3 – range high
40010	Chart – Trace 3 – range low
40012	Chart – Trace 4 – range high
40014	Chart – Trace 4 – range low

B.8.2 Sensor coefficients (turbidity only)

MODBUS address	Description
40016	Sensor 1 – FTU mg/l coefficient
40018	Sensor 2 – FTU mg/l coefficient
40020	Sensor 3 – FTU mg/l coefficient
40022	Sensor 4 – FTU mg/l coefficient

B.8.3 Alarm settings

MODBUS address	Description
40024	Alarm 1 – Trip point
40026	Alarm 2 – Trip point
40028	Alarm 3 – Trip point
40030	Alarm 4 – Trip point
40032	Alarm 5 – Trip point
40034	Alarm 6 – Trip point
40036	Alarm 7 – Trip point
40038	Alarm 8 – Trip point
40040	Alarm 1 – Hysteresis
40042	Alarm 2 – Hysteresis
40044	Alarm 3 – Hysteresis
40046	Alarm 4 – Hysteresis
40048	Alarm 5 – Hysteresis
40050	Alarm 6 – Hysteresis
40052	Alarm 7 – Hysteresis
40054	Alarm 8 – Hysteresis

B.8.4 Analog output settings – see engineering ranges table (Section B.12, page 49)

MODBUS address	Description
40056	Analog output 1 – Electrical range high
40058	Analog output 1 – Electrical range low
40060	Analog output 1 – Engineering range high
40062	Analog output 1 – Engineering range low
40064	Analog output 2 – Electrical range high
40066	Analog output 2 – Electrical range low
40068	Analog output 2 – Engineering range high
40070	Analog output 2 – Engineering range low
40072	Analog output 3 – Electrical range high
40074	Analog output 3 – Electrical range low
40076	Analog output 3 – Engineering range high
40078	Analog output 3 – Engineering range low
40080	Analog output 4 – Electrical range high
40082	Analog output 4 – Electrical range low
40084	Analog output 4 – Engineering range high
40086	Analog output 4 – Engineering range low
40088	Analog output 1 – Failure current
40090	Analog output 2 – Failure current
40092	Analog output 3 – Failure current
40094	Analog output 4 – Failure current

B.8.5 Sensor calibration correction (RDO only) – see engineering ranges table (Section B.12, page 49)

MODBUS address	Description
40096	Sensor 1 calibration salinity correction
40098	Sensor 2 calibration salinity correction
40100	Sensor 3 calibration salinity correction
40102	Sensor 4 calibration salinity correction
40104	Sensor 1 calibration pressure correction
40106	Sensor 2 calibration pressure correction
40108	Sensor 3 calibration pressure correction
40110	Sensor 4 calibration pressure correction

B.9 Writable 16 bits – alarm time hysteresis (valid range 0 to 9999 seconds)

MODBUS address	Description
42000	Alarm 1 – Time hysteresis
42001	Alarm 2 – Time hysteresis
42002	Alarm 3 – Time hysteresis
42003	Alarm 4 – Time hysteresis
42004	Alarm 5 – Time hysteresis
42005	Alarm 6 – Time hysteresis
42006	Alarm 7 – Time hysteresis
42007	Alarm 8 – Time hysteresis

B.10 Writable 8 bits

B.10.1 Measurement units

MODBUS address	Description	Valid range	
43000	Transmitter – temperature units	13 – Deg. C	14 – Deg. F
43001	Calibration salinity correction units	30 – PSU	31 – ppt
43002	Calibration pressure correction units	32 – millibar	33 – mmHg
43003	Sensor 1 – dissolved oxygen units	5 – ppm	6 – mg/l
43004	Sensor 2 – dissolved oxygen units		
43005	Sensor 3 – dissolved oxygen units		
43006	Sensor 4 – dissolved oxygen units		

B.10.2 Digital filter

MODBUS address	Description	Valid range	
43006	Sensor 4 – dissolved oxygen units		
43007	Sensor 1 – Filter type	0 – Off	
		1 – Minimum value	2 – Maximum value
		3 – Average value	4 – Sliding average
43008	Sensor 1 – Flow measurement	0 – Disabled	1 – Enabled
43009	Sensor 2 – Filter type	See Sensor 1	
43010	Sensor 2 – Flow measurement	0 – Disabled	1 – Enabled
43011	Sensor 3 – Filter type	See Sensor 1	
43012	Sensor 3 – Flow measurement	0 – Disabled	1 – Enabled
43013	Sensor 4 – Filter type	See Sensor 1	
43014	Sensor 4 – Flow measurement	0 – Disabled	1 – Enabled

B.10.3 PV signal resolution

MODBUS address	Description	Valid range	
43015	Sensor 1 – PV signal resolution	0 – PV resolution default	1 – PV resolution high
43016	Sensor 2 – PV signal resolution		
43017	Sensor 3 – PV signal resolution		
43018	Sensor 4 – PV signal resolution		

B.10.4 Sensor Clean Settings

MODBUS address	Description	Valid range
43019	Sensor 1 – clean frequency	0 to 3, 4 to 96 in increments of 4 – see clean frequency table (Section B.12.4, page 50)
43020	Sensor 2 – clean frequency	
43021	Sensor 3 – clean frequency	
43022	Sensor 4 – clean frequency	
43023	Sensor 1 – Clean type	0 – Continuous 1- Pulsed
43024	Sensor 2 – Clean type	
43025	Sensor 3 – Clean type	
43026	Sensor 4 – Clean type	
43027	Sensor 1 – Clean on time	1 to 60 minutes
43028	Sensor 2 – Clean on time	
43029	Sensor 3 – Clean on time	
43030	Sensor 4 – Clean on time	
43031	Sensor 1 – Clean off time	
43032	Sensor 2 – Clean off time	
43033	Sensor 3 – Clean off time	
43034	Sensor 4 – Clean off time	
43035	Sensor 1 – Clean pulses	0 to 9 – see clean pulses table (Section B.12.5, page 50)
43036	Sensor 2 – Clean pulses	
43037	Sensor 3 – Clean pulses	
43038	Sensor 4 – Clean pulses	
43039	Sensor 1 – Clean recovery time	0 to 9 – see clean recovery time table (Section B.12.6, page 50)
43040	Sensor 2 – Clean recovery time	
43041	Sensor 3 – Clean recovery time	
43042	Sensor 4 – Clean recovery time	
43043	Sensor 1 – Clean assignment	0 to 12 – see clean output assignment table (Section B.12.7, page 50)
43044	Sensor 2 – Clean assignment	
43045	Sensor 3 – Clean assignment	
43046	Sensor 4 – Clean assignment	

B.10.5 Sensor measurement hold

MODBUS address	Description	Valid range
43047	Sensor 1 – Hold	0 – No hold 1 – Hold
43048	Sensor 2 – Hold	
43049	Sensor 3 – Hold	
43050	Sensor 4 – Hold	

B.10.6 Operator page templates

MODBUS address	Description	Valid range
43051	Operator page 2 template	0 – Off
43052	Operator page 3 template	1 – Sensor 1 2 – Sensor 2
43053	Operator page 4 template	3 – Sensor 3 4 – Sensor 4
43054	Operator page 5 template	

B.10.7 Data view/ log enables

MODBUS address	Description	Valid range
43055	Diagnostics view	0 – Disabled 1 – Enabled
43056	Signals view	
43057	Chart view	
43058	Alarm view	
43059	Analog output view	
43060	Calibration log	
43061	Alarm log	
43062	Audit log	
43063	Diagnostics log	

B.10.8 Date display settings

MODBUS address	Description	Valid range
43064	Date format	0 – dd/mm/yyyy 1 – mm/dd/yyyy 2 – yyyy/mm/dd
43065	Daylight saving – region	0 – Daylight saving is off 1 – Europe 2 – USA 3 – Custom
43066	Daylight saving – start hour for daylight saving	0 to 23
43067	Daylight saving – start occurrence for daylight saving	1 – First 2 – Second 3 – Third 4 – Fourth 5 – Last
43068	Daylight saving – start day for daylight saving	1 to 7 where 1 = Sunday and 7 = Saturday
43069	Daylight saving – start month for daylight saving	1 to 12 where 1 = January and 12 = December
43070	Daylight saving – end hour for daylight saving	0 to 23
43071	Daylight saving – end occurrence for daylight saving	1 – First 2 – Second 3 – Third 4 – Fourth 5 – Last
43072	Daylight saving – end day for daylight saving	1 to 7 where 1 = Sunday and 7 = Saturday

B.10.9 Alarm settings

MODBUS address	Description	Valid range
43074	Alarm 1 – Type	0 – Off 1 – High process 2 – Low process 3 – High latch 4 – Low latch
43075	Alarm 1 – Source	0 to 8 – see signal source list (Section B.12.1, page 49)
43076	Alarm 2 – Type	See Alarm 1 – Type
43077	Alarm 2 – Source	See Alarm 1 – Source
43078	Alarm 3 – Type	See Alarm 1 – Type
43079	Alarm 3 – Source	See Alarm 1 – Source
43080	Alarm 4 – Type	See Alarm 1 – Type
43081	Alarm 4 – Source	See Alarm 1 – Source
43082	Alarm 5 – Type	See Alarm 1 – Type
43083	Alarm 5 – Source	See Alarm 1 – Source
43084	Alarm 6 – Type	See Alarm 1 – Type
43085	Alarm 6 – Source	See Alarm 1 – Source
43086	Alarm 7 – Type	See Alarm 1 – Type
43087	Alarm 7 – Source	See Alarm 1 – Source
43088	Alarm 8 – Type	See Alarm 1 – Type
43089	Alarm 8 – Source	See Alarm 1 – Source

B.10.10 Analog output settings

MODBUS address	Description	Valid range
43090	Analog output 1 – Source	0 to 8 – see signal source list (Section B.12.1, page 49)
43091	Analog output 1 – Output type	0 – Linear 1 – Logarithmic (2 decades) 2 – Logarithmic (3 decades) 3 – Logarithmic (4 decades)
43092	Analog output 1 – Failure current enable	0 – Enabled 1 – Disabled
43093	Analog output 2 – Source	See Analog output 1 – Source
43094	Analog output 2 – Output type	See Analog output 1 – Output type
43095	Analog Output 2 – Failure current enable	0 – Enabled 1 – Disabled
43096	Analog Output 3 – Source	See Analog output 1 – Source
43097	Analog output 3 – Output type	See Analog output 1 – Output type
43098	Analog output 3 – Failure current enable	0 – Enabled 1 – Disabled
43099	Analog output 4 – Source	See Analog output 1 – Source
43100	Analog output 4 – Output type	See Analog output 1 – Output type
43101	Analog Output 4 – failure current enable	0 – Enabled 1 – Disabled

B.10.11 Digital I/O settings

MODBUS address	Description	Valid range
43102	Digital I/O 1 – Type	0 – Off 2 – Digital input (volt-free)
		1 – Digital output 3 – Digital input (24 V)
43103	Digital I/O 1 – Source	0, and 9 to 52 (output) See signal source list (Section B.12.1, page 49)
43104	Digital I/O 1 – Polarity	0 – Inverted 1 – Non inverted
43105	Digital I/O 2 – Type	See Digital I/O 1 – Type
43106	Digital I/O 2 – Source	See Digital I/O 1 – Source
43107	Digital I/O 2 – Polarity	0 – Inverted 1 – Non inverted
43108	Digital I/O 3 – Type	See Digital I/O 1 – Type
43109	Digital I/O 3 – Source	See Digital I/O 1 – Source
43110	Digital I/O 3 – Polarity	0 – Inverted 1 – Non inverted
43111	Digital I/O 4 – Type	See Digital I/O 1 – Type
43112	Digital I/O 4 – Source	See Digital I/O 1 – Source
43113	Digital I/O 4 – Polarity	0 – Inverted 1 – Non inverted
43114	Digital I/O 5 – Type	See Digital I/O 1 – Type
43115	Digital I/O 5 – Source	See Digital I/O 1 – Source
43116	Digital I/O 5 – Polarity	0 – Inverted 1 – Non inverted
43117	Digital I/O 6 – Type	See Digital I/O 1 – Type
43118	Digital I/O 6 – Source	See Digital I/O 1 – Source
43119	Digital I/O 6 – Polarity	0 – Inverted 1 – Non inverted

B.10.12 Relay settings

MODBUS address	Description	Valid range
43120	Relay 1 – Source	0, and 9 to 44 and 49 to 53 See signal source list (Section B.12.1, page 49)
43121	Relay 1 – Polarity	0 – inverted 1 – Non inverted
43122	Relay 2 – Source	See Relay 1 – Source
43123	Relay 2 – Polarity	0 – inverted 1 – Non inverted
43124	Relay 3 – Source	See Relay 1 – Source
43125	Relay 3 – Polarity	0 – inverted 1 – Non inverted
43126	Relay 4 – Source	See Relay 1 – Source
43127	Relay 4 – Polarity	0 – inverted 1 – Non inverted
43128	Relay 5 – Source	See Relay 1 – Source
43129	Relay 5 – Polarity	0 – inverted 1 – Non inverted
43130	Relay 6 – Source	See Relay 1 – Source
43131	Relay 6 – Polarity	0 – inverted 1 – Non inverted

B.11 Writable strings

B.11.1 16 Byte strings

MODBUS address	Description	Default
44000	Instrument tag	Aztec 400
44016	Process tag 1	Tag 1
44032	Process tag 2	Tag 2
44048	Process tag 3	Tag 3
44064	Process tag 4	Tag 4
44080	Alarm 1 tag	Alarm 1
44096	Alarm 2 tag	Alarm 2
44112	Alarm 3 tag	Alarm 3
44128	Alarm 4 tag	Alarm 4
44144	Alarm 5 tag	Alarm 5
44160	Alarm 6 tag	Alarm 6
44176	Alarm 7 tag	Alarm 7
44192	Alarm 8 tag	Alarm 8

B.11.2 3 Byte strings

MODBUS address	Description	Default
44208	Chart config tag 1	Ch 1
44211	Chart config tag 2	Ch 2
44214	Chart config tag 3	Ch 3
44217	Chart config tag 4	Ch 4

B.12 Engineering ranges

Source	Range low	Range high	Units
Dissolved oxygen concentration	0	50	mg/l or ppm
Dissolved oxygen percentage	0	200	%
Salinity correction	0	42	PSU or ppt
Barometric pressure correction	507 (380)	1113 (835)	mbar (mmHg)
Analog output electrical range	0	22	mA

B.12.1 Signal source list

Signal value	Source name
0	None
1	anlIP1 – Sensor 1 concentration
2	anlIP2 – Sensor 1 temperature
3	anlIP3 – Sensor 2 concentration
4	anlIP4 – Sensor 2 temperature
5	anlIP5 – Sensor 3 concentration
6	anlIP6 – Sensor 3 temperature
7	anlIP7 – Sensor 4 concentration
8	anlIP8 – Sensor 4 temperature
9	AlarmState1
10	AlarmState2
11	AlarmState3
12	AlarmState4
13	AlarmState5
14	AlarmState6
15	AlarmState7
16	AlarmState8
17	sensor1_fail
18	sensor2_fail
19	sensor3_fail
20	sensor4_fail
21	sensor1_out_of_spec
22	sensor2_out_of_spec
23	sensor3_out_of_spec
24	sensor4_out_of_spec
25	sensor1_maintenance
26	sensor2_maintenance
27	sensor3_maintenance
28	sensor4_maintenance
29	sensor1_function_check
30	sensor2_function_check
31	sensor3_function_check
32	sensor4_function_check
33	transmitter_failure
34	transmitter_out_of_spec
35	transmitter_maintenance
36	transmitter_function_check
37	sensor1_cal_in_progress
38	sensor2_cal_in_progress
39	sensor3_cal_in_progress
40	sensor4_cal_in_progress
41	sensor1_cal_failed
42	sensor2_cal_failed

Signal value	Source name
43	sensor3_cal_failed
44	sensor4_cal_failed
45	sensor1_flow_status
46	sensor2_flow_status
47	sensor3_flow_status
48	sensor4_flow_status
49	sensor1_clean
50	sensor2_clean
51	sensor3_clean
52	sensor4_clean
53	sensor1_hold
54	sensor2_hold
55	sensor3_hold
56	sensor4_hold
57	sensor1_clean_sequence
58	sensor2_clean_sequence
59	sensor3_clean_sequence
60	sensor4_clean_sequence

B.12.2 Signal view allocations (RDO)

Signal view allocations	Dissolved oxygen
Sensor 1 – Signal view 1	Cyclic data concentration S1
Sensor 1 – Signal view 2	Cyclic data percentage S1
Sensor 1 – Signal view 3	Cyclic data temperature S1
Sensor 1 – Signal view 4	Calibration slope S1
Sensor 1 – Signal view 5	Calibration offset S1
Sensor 1 – Signal view 6	RDO cap expiry S1 (weeks)
Sensor 1 – Signal view 7	N/A
Sensor 1 – Signal view 8	N/A
Sensor 2 – Signal view 1	Cyclic data concentration S2
Sensor 2 – Signal view 2	Cyclic data percentage S2
Sensor 2 – Signal view 3	Cyclic data temperature S2
Sensor 2 – Signal view 4	Calibration slope S2
Sensor 2 – Signal view 5	Calibration offset S2
Sensor 2 – Signal view 6	RDO cap expiry S2 (weeks)
Sensor 2 – Signal view 7	N/A
Sensor 2 – Signal view 8	N/A
Sensor 3 – Signal view 1	Cyclic data concentration S3
Sensor 3 – Signal view 2	Cyclic data percentage S3
Sensor 3 – Signal view 3	Cyclic data temperature S3
Sensor 3 – Signal view 4	Calibration slope S3
Sensor 3 – Signal view 5	Calibration offset S3
Sensor 3 – Signal view 6	RDO cap expiry S3 (weeks)
Sensor 3 – Signal view 7	N/A
Sensor 3 – Signal view 8	N/A
Sensor 4 – Signal view 1	Cyclic data concentration S4
Sensor 4 – Signal view 2	Cyclic data percentage S4
Sensor 4 – Signal view 3	Cyclic data temperature S4
Sensor 4 – Signal view 4	Calibration slope S4
Sensor 4 – Signal view 5	Calibration offset S4
Sensor 4 – Signal view 6	RDO cap expiry S4 (weeks)
Sensor 4 – Signal view 7	N/A
Sensor 4 – Signal view 8	N/A

B.12.3 Sensor type valid range

Signal value	Description
0	Unrecognized (default)
10	2e_conductivity
20	Toroidal
30	4e_conductivity
42	RDO
60	pH
70	Turbidity IR low
71	Turbidity IR high
72	Turbidity SS plastic
73	Turbidity SS plastic wiper
75	Turbidity WL
76	Turbidity WL high
72	Turbidity SS stainless
73	Turbidity SS stainless wiper
80	Low level dissolved oxygen
255	No sensor fitted

B.12.4 Clean frequency

Signal value	Description
0	off
1	15 minutes
2	30 minutes
3	45 minutes
4	1 hour
8	2 hours
12	3 hours
16	4 hours
20	5 hours
24	6 hours
28	7 hours
32	8 hours
36	9 hours
40	10 hours
44	11 hours
48	12 hours
52	13 hours
56	14 hours
60	15 hours
64	16 hours
68	17 hours
72	18 hours
76	19 hours
80	20 hours
84	21 hours
88	22 hours
92	23 hours
96	24 hours

B.12.5 Clean pulses

Signal value	Description
0	1 pulse
1	2 pulses
2	3 pulses
3	4 pulses
4	5 pulses
5	6 pulses
6	7 pulses
7	8 pulses
8	9 pulses
9	10 pulses

B.12.6 Clean recovery time

Signal value	Description
0	1 minute
1	2 minutes
2	3 minutes
3	4 minutes
4	5 minutes
5	6 minutes
6	7 minutes
7	8 minutes
8	9 minutes
9	10 minutes

B.12.7 Clean output assignment

Signal value	Description
0	None
1	Relay 1
2	Relay 2
3	Relay 3
4	Relay 4
5	Relay 5
6	Relay 6
7	DIO 1
8	DIO 2
9	DIO 3
10	DIO 4
11	DIO 5
12	DIO 6

Appendix C – Acknowledgements

PROFIBUS is a registered trademark of PROFIBUS organization.

MODBUS is a registered trademark of the Modbus-IDA organization



Sales



Service



Software

ABB Limited

Measurement & Analytics

Oldends Lane, Stonehouse
Gloucestershire,
GL10 3TA
UK

Tel: +44 (0)1453 826661

Fax: +44 (0)1453 829671

Email: instrumentation@gb.abb.com

ABB Inc.

Measurement & Analytics

125 E County Line Road
Warminster, PA 18974
USA

Tel: +1 215 674 6000

Fax: +1 215 674 7183

abb.com/measurement



We reserve the right to make technical changes or modify the contents of this document without prior notice. With regard to purchase orders, the agreed particulars shall prevail. ABB does not accept any responsibility whatsoever for potential errors or possible lack of information in this document.

We reserve all rights in this document and in the subject matter and illustrations contained therein. Any reproduction, disclosure to third parties or utilization of its contents – in whole or in parts – is forbidden without prior written consent of ABB.