

## Contents

<b>Foreword</b> .....	<b>i</b>
<b>1. Functional Description</b> .....	<b>1</b>
1.1 Overview and Features .....	1
1.2 Instrument Configuration .....	2
1.3 Control Functions .....	4
1.4 Program Control Function (/PG option).....	10
1.5 Input Function .....	13
1.6 Output Function .....	16
1.7 Alarm Function .....	18
1.8 Action Function (Contact Input Switch Function) .....	21
1.9 Control Event Action Function .....	22
1.10 Operation Screen .....	24
1.11 PC Software .....	28
1.12 Web Application .....	30
1.13 Control Data and I/O Data Acquisition/Recording Function.....	31
1.14 Screen Transitions.....	32
1.15 Application Examples .....	34
<b>2. Using the Control Function for the First Time</b> .....	<b>38</b>
2.1 Overview.....	38
2.2 Initial Configuration.....	39
2.3 Monitoring and Controlling .....	47
2.3.1 Displaying the Monitoring Screen.....	47
2.3.2 Changing Target Setpoints .....	49
2.3.3 Determining the Optimal PID with Auto-Tuning.....	51
2.3.4 Stopping and Running Operations .....	54
2.3.5 Switching between Auto and Manual Modes .....	56
2.3.6 Controlling the Control Output in Manual Mode .....	58
<b>3. Program Pattern Examples</b> .....	<b>60</b>
<b>Technical Information</b> .....	<b>i</b>

---

Blank Page

---

# Foreword

This manual describes the GX10, GX20, GP10, and GP20 paperless recorders with PID control module, or the data acquisition system GM with PID control module.

This document describes the function outline of the PID control module. In order to understand the basic setting method, explanation is given using the setting examples.

## ■ Applicable products

GX10, GX20, GP10, and GP20 paperless recorders (release number R4) or data acquisition system GM (release number R4) and PID control module GX90UT.

For the program control, GX10, GX20, GP10, and GP20 paperless recorders with /PG option (release number R4) or data acquisition system GM with /PG option (release number R4) and PID control module GX90UT.

## ■ Precautions

- The contents of this manual may change without notice due to performance and functional improvements.
- Every effort has been made in the preparation of this manual to ensure the accuracy of its contents. However, should you have any questions or find any errors, please contact your nearest YOKOGAWA representative as listed on the back cover of this manual.
- Copying or reproduction by any means of all or any part of the contents of this manual without permission is strictly prohibited.

## ■ Trademarks

- The Yokogawa company and brand names used in this manual are trademarks or registered trademarks of Yokogawa Electric Corporation.
- Adobe and Adobe Acrobat are trademarks of Adobe Systems Incorporated in the United States and/or other countries.
- The company trademarks and registered trademarks used in this manual are not accompanied by the trademark or registered trademark symbols (™ and ®).
- The product names used in this manual are trademarks or registered trademarks of their respective holders.

---

Blank Page



---

# 1. Functional Description

## 1.1 Overview and Features

The GX90UT is a PID control module that connects to a GX/GP main unit, GX60 expandable I/O unit, GM main unit, or GM sub unit.

This chapter provides an overview of the main functions. For further details, see chapter 3 and subsequent chapters.

### GX90UT PID Control Module



- A single GX90UT PID Control Module can perform PID control on up to two loops. It is equipped with two control inputs (PV inputs), two control outputs, eight digital inputs, and eight digital outputs. In addition to single loop control, cascade control and loop control with PV switching are possible. For the control output, you can select current output or voltage pulse for each loop.
- Loop control is possible by installing the PID Control Module in the GX/GP/GM. Control loops can be monitored and controlled from a control group screen, and adjustments can be made from a tuning screen.
- The /PG option of the GX/GP/GM main unit enables program control using program patterns stored in the GX/GP main unit.
- The GX90UT control data can be acquired and recorded in the GX/GP/GM main unit.

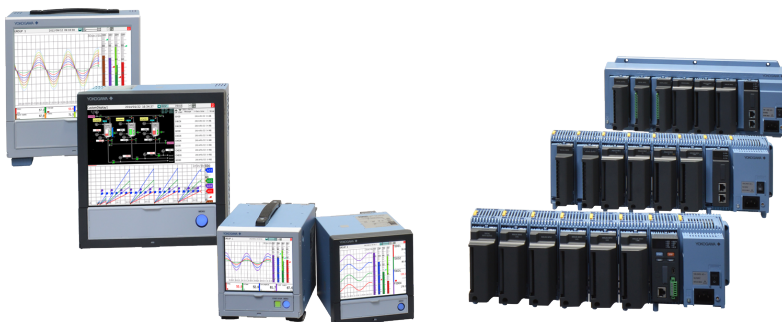

## 1.2 Instrument Configuration

The instrument configuration when PID Control Modules are used is indicated below.

### Configuration with Only the GX/GP Main Unit

GX10/GP10 main unit only



Standard type

PID control module **up to 3 units (up to 6 loops)**

The maximum number is 2 when the GP10 supply voltage is 12 VDC.

GX20/GP20 main unit only

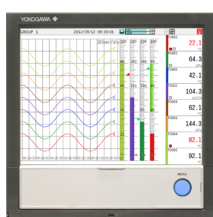

Standard type

PID control module **up to 3 units (up to 6 loops)**

Large memory type

PID control module **up to 8 units (up to 16 loops)**

### Configuration with the GX/GP Main Unit and Expandable I/O

GX10/GP10 main unit  
GX20/GP20 main unit

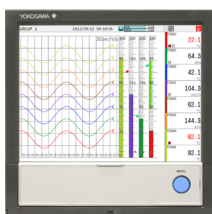

Expandable I/O  
Up to six units

The number of units used in the system is

Standard type

PID control module **up to 3 units  
(up to 6 loops)**

Large memory type

PID control module **up to 10 units  
(up to 20 loops)**

#### NOTE

- If the system includes digital output modules (GX90YD) or digital input/output modules (GX90WD) in addition to PID control modules (GX90UT), the maximum total number of these three modules is 10.
- If the main unit's measurement mode is high speed, dual interval or if the advanced security function is enabled, PID control modules will not work.

## GM Single Unit Configuration

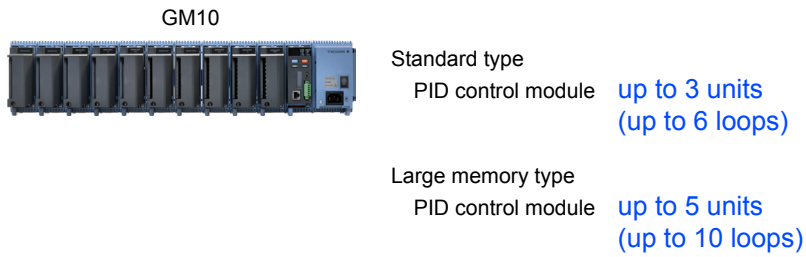

## GM Multi Unit Configuration

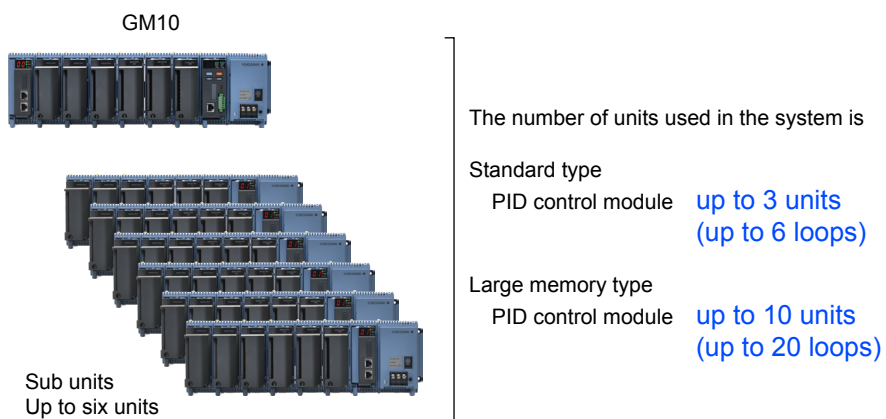

### NOTE

- If the system includes digital output modules (GX90YD) or digital input/output modules (GX90WD) in addition to PID control modules (GX90UT), the maximum total number of these three modules is 10.
- If the main unit's measurement mode is dual interval or if the advanced security function is enabled, PID control modules will not work.

## 1.3 Control Functions

### Control Mode

Control modes define the controls that a single PID Control Module can execute. The PID Control Module operates in the following manner by setting the control mode to execute.

Control mode schematic diagram	Description
<p>Single loop control</p>	<p>“Single-loop control” provides the basic control function having one control computation unit. A single PID Control Module can perform two single-loop controls.</p>
<p>Cascade control</p>	<p>“Cascade control” has two control computation units and provides a control function that executes cascade control from a single PID Control Module. It is a type of control that provides the primary control output as the secondary control SP.</p>
<p>Loop Control with PV Switching</p>	<p>“Loop control with PV switching” uses two PV inputs, which are switched according to input contact signals or measurement ranges.</p>

#### Explanation of Symbols

AI1: analog input 1, AI2: analog input 2

PV1: PV input 1 (loop 1 or primary side), PV2: PV input 2 (loop 2 or secondary side)

SP1: target setpoint 1 (loop 1 or primary side), SP2: target setpoint 2 (loop 2 or secondary side)

PID1: PID computation 1 (loop 1 or primary side), PID2: PID computation 2 (loop 2 or secondary side)

OUT1: control output 1 (loop 1 or primary side), OUT2: control output 2 (loop 2 or secondary side)

AO1: analog output 1, AO2: analog output 2

DI: contact input

The three control modes can be applied to the following types of application. Examples of GX20 are described below.

### Industrial furnace temperature control (single-loop control)

Rich recipe management improves yield.

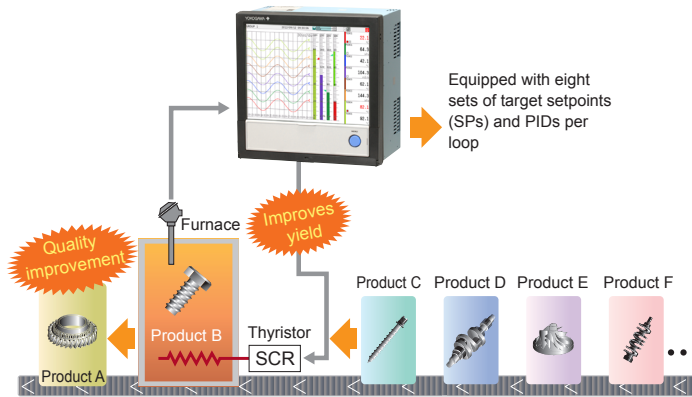

### Cascade Control

Control targets with extremely long delay between changes in the control output and measurements on the control target or extremely long dead times can be controlled.

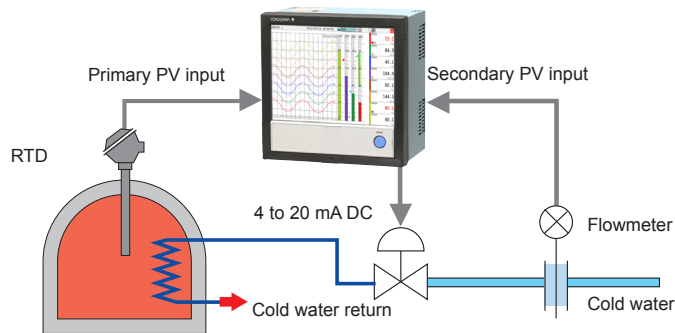

### Loop Control with PV Switching

Control input is automatically switched depending on the temperature region.

During low temperature, PV input from a thermocouple is used to perform control, and during high temperature, PV input from a radiation thermometer is used to perform control. When a switch occurs from low temperature to high temperature, a thermocouple pull-out signal is output.

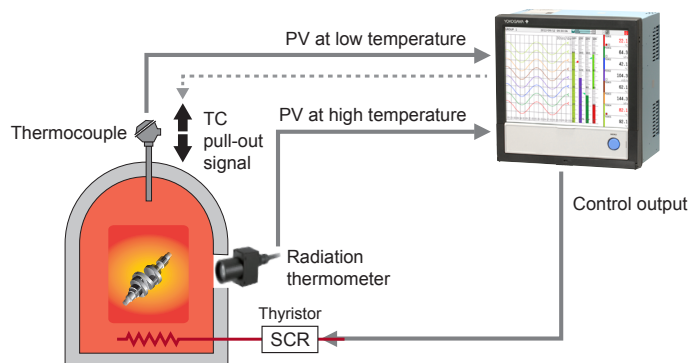

## Control Type

### PID Control

PID control is a general control using the PID control-related parameters. Continuous PID output (current output) or time proportional PID output (voltage pulse output) can be used.

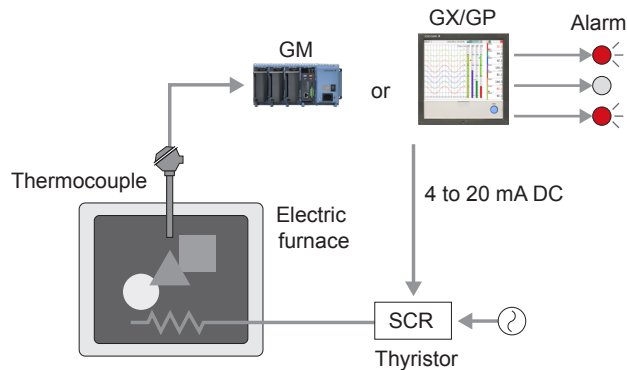

- Continuous PID control: Outputs the PID computation result using a current (analog signal) proportional to the PID computation value.
- Time proportional PID control: Outputs the PID computation result using an on/off signal pulse width proportional to the time. The pulse width is output a percentage of the cycle time (control output cycle) using a voltage pulse.

### ON/OFF control

ON/OFF control compares the SP and PV and outputs an on or off signal according to the positive or negative deviation ( $PV - SP$ ).

Hysteresis can be set in the vicinity of the on/off output operating point to prevent chattering. The output type is voltage pulse output or current output.

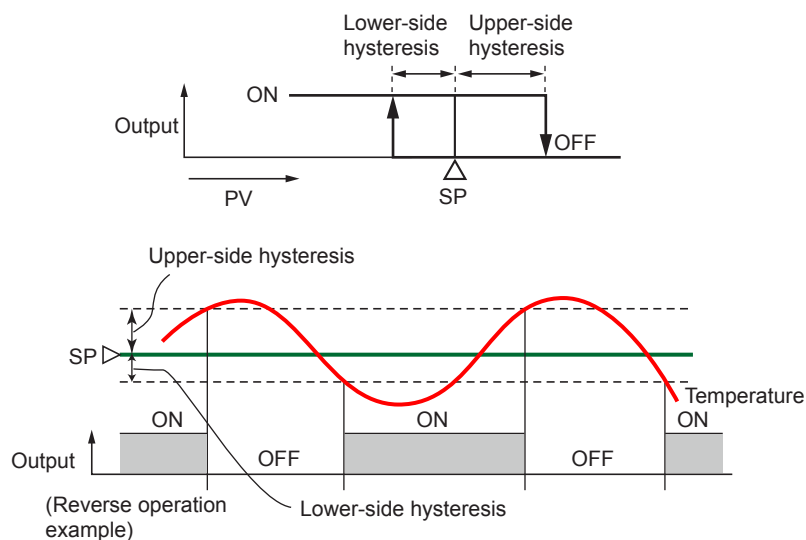

## PID Control Mode

There are two PID control modes: standard PID control mode and fixed-point control mode.

In standard PID control mode, when the SP is changed, the output corresponding to the deviation is changed immediately. This mode focuses on reaching the setpoint quickly.

In fixed-point control mode, sensitive reaction in response to changes in the SP is suppressed. This mode focuses on stable output.

The GX90UT automatically selects the optimal control algorithm according to the operation mode status and performs control.

- PV derivative type PID: Because derivative actions work only on the PV, stable control output is possible. Even when the SP is changed significantly, the control output does not change drastically, and the deviation is gradually eliminated.

PV derivative type PID (output bump at SP change)

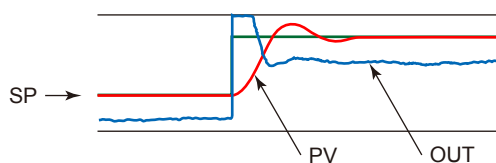

PV derivative type PID (output bumpless at SP change)

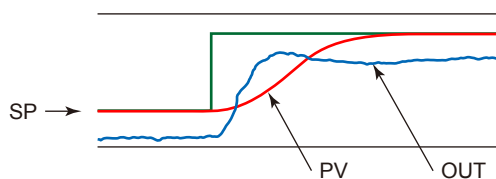

- Deviation derivative type PID: Because derivative actions work on the changes in the control deviation (difference between the PV and SP), quick response is exhibited to changes in the target setpoint. This method is useful when SP trackability is important.

Deviation derivative type PID

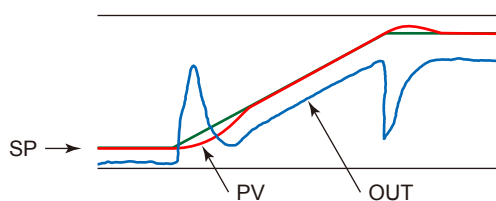

## Overshoot Suppressing Function (Super function)

“Super” function is an overshoot-suppressing function that uses fuzzy logic.

When used in combination with the auto-tuning function, the overshoot suppressing function proves effective in the following situations.

- When you want to suppress overshoot
- When you want to reduce rise time
- When there is a great amount of load fluctuation
- When the setpoint is changed frequently

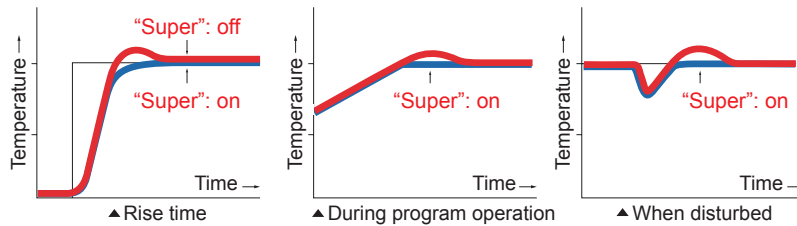

## Direct Operation and Reverse Operation

There are two PID control output operation directions: direct and reverse.

These define the increase and decrease directions in which the control output changes in response to positive and negative deviation between the SP and PV.

## Over-Integration Suppressing Function (Anti-reset windup)

If the deviation between the SP and PV continues for a long time, integral action causes the control output to reach the control output high limit and saturate. Because the control output cannot disengage from the saturated state even when the PV exceeds the SP, overshooting can occur. The over-integration suppression function stops the integral action temporarily when the control output reaches the control output high limit.

## SP Ramp-Rate Setting Function

The SP ramp-rate setting function forces the SP to change at a fixed rate in order to prevent abrupt changes in the SP or change the SP at a constant rate-of-change.

## SP Limiter Function

The SP limiter function enables high and low limits to be placed on the SP.



## Tracking Function

The tracking function prevents the setpoint from changing drastically when the operation mode is changed. PV tracking and SP tracking are available.

### PV tracking

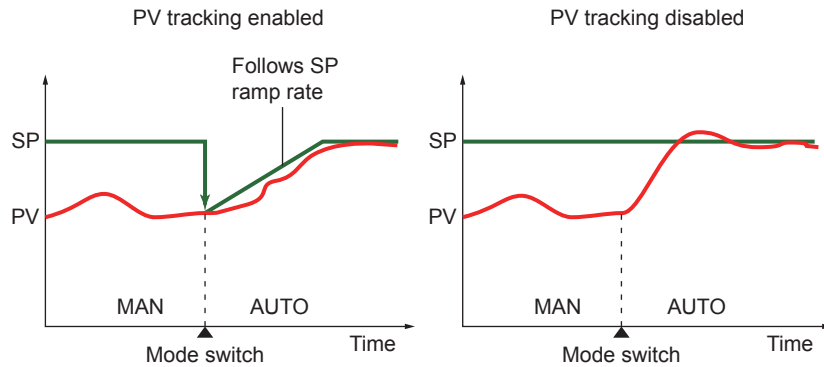

### SP tracking

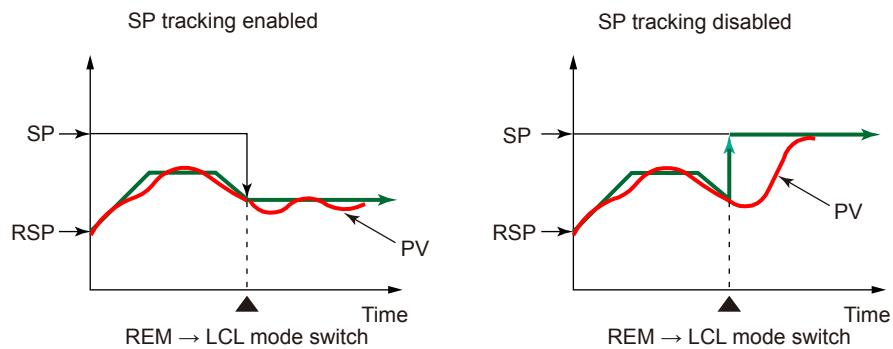

### Explanation of Symbols

MAN: manual mode, AUTO: auto mode  
 REM: remote mode, LCL: local mode

# 1.4 Program Control Function (/PG option)

Program control is possible on the GX/GP/GM with the /PG option.

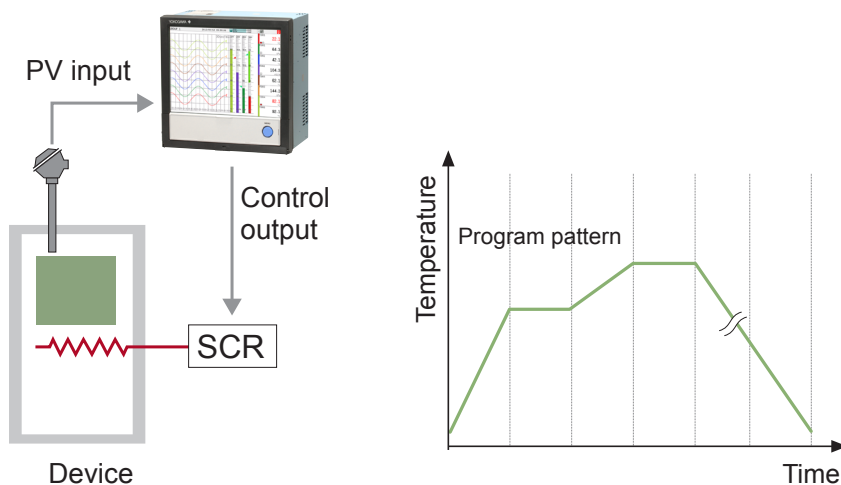

The program operation can be used to change the SP over time according to a preset program pattern.

A program pattern consists of several segments.

You can create a program pattern by setting the final target setpoint of each segment, segment time, PV events, time events, and so on.

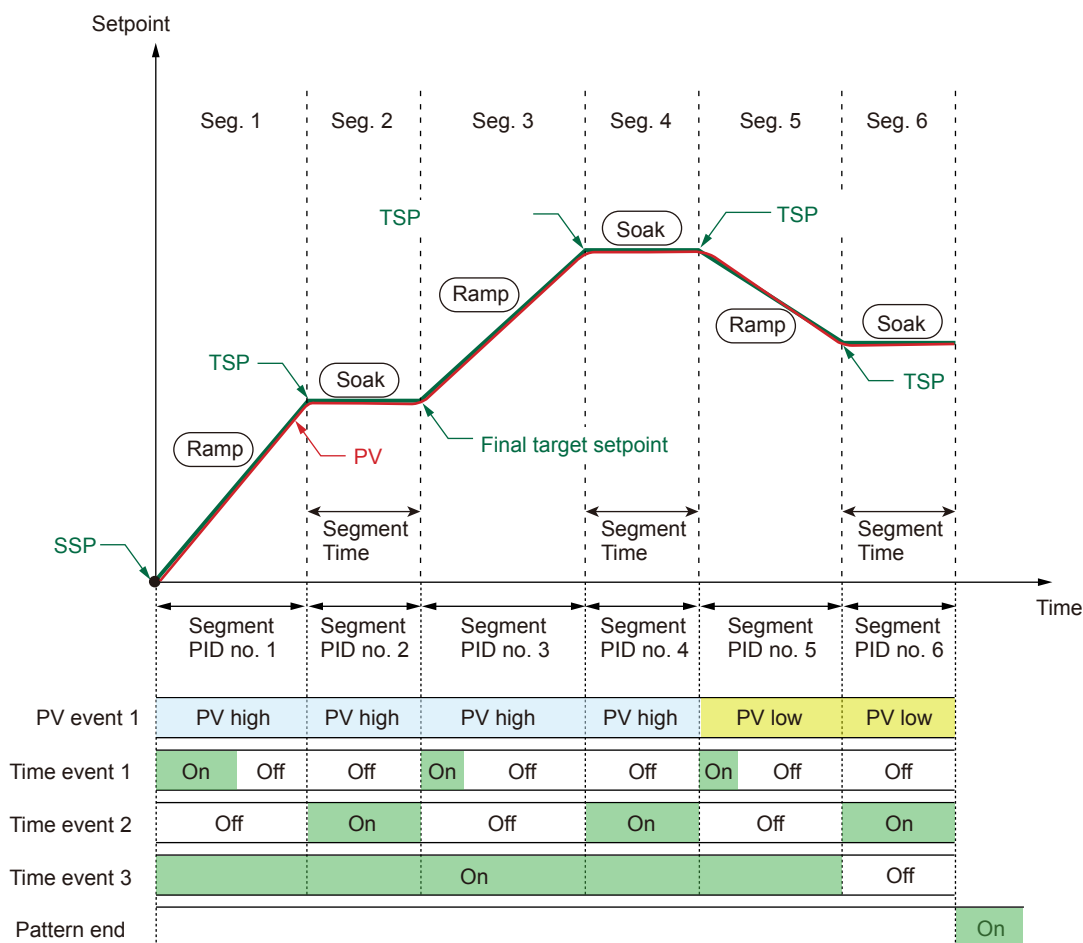

---

## Program Control Functions

### Wait Function

The wait function pauses the progression of a program when the PV cannot follow the SP.

### Repeat Function

The repeat function repeatedly runs a given segment (consecutive multiple segments also possible) in a program pattern.

### Program Operation Pause (Hold Function)

The hold function forces the operation of a program pattern to pause when the program is running.

### Program Segment Advance

The advance function forces a program pattern to transition to the next segment when the program is running.

### Event Function

The event function can be used to output alarms according to the progression of program pattern operation or turn on or off the contact output after a given time elapses.

### Time Event

The time event function turns on or off the contact output when a specified time elapses from the start of a segment operation.

### PV Event

The PV function outputs alarms according to the progression of program pattern operation. Events operate only within the specified segments.

### PID Selection

You can select zone PID selection, which selects the PID according to the PV or SP, or segment PID section, which selects the PID for each segment.

### Local Mode

The local mode function stops program operation and performs fixed-point control.

## Creating Program Patterns

To create a program pattern, you set a line graph of target setpoints in each segment using the final target setpoint (TSP) at the end of each segment and the segment time. You set a final target setpoint for each loop. The segment time applies to all loops.

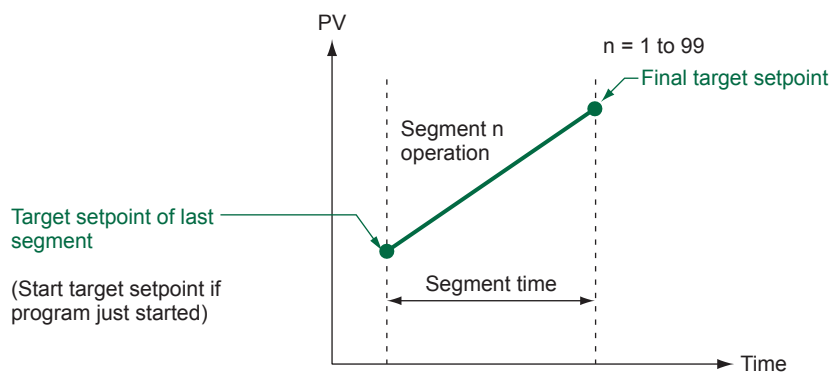

## Program Operation Start Action

### Starting with the Start Target Setpoint

The program operation starts according to a pattern created with the target setpoint for starting the operation and the final target setpoint (TSP) of the first segment, regardless of the PV when the operation starts.

### Ramp-Prioritized PV Start

Ramp-prioritized program runs according to the loop specified with the reference loop number. This method determines the start point by comparing the PV at the start of the nth pattern to the program pattern.

Other unspecified loops start according to the pattern of the specified nth pattern.

### Time-Prioritized PV Start

The program operation starts according to a pattern created with the PV for starting the operation and the final target setpoint (TSP) of the first segment, regardless of the SP when the operation starts.

## 1.5 Input Function

### PV Input

PV input is a universal input to arbitrarily set the type and range for the thermocouple (TC), resistance-temperature detector (RTD), DC voltage and DI.

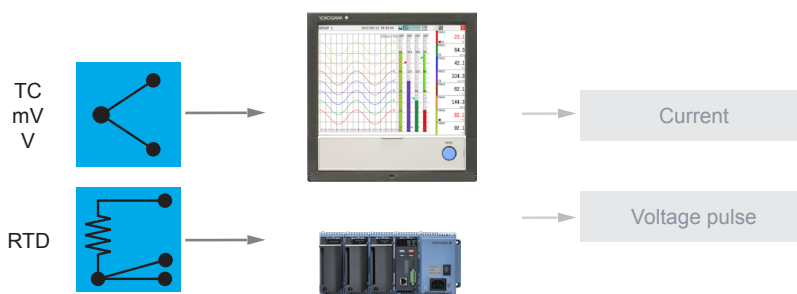

#### Range Setting for Temperature Input

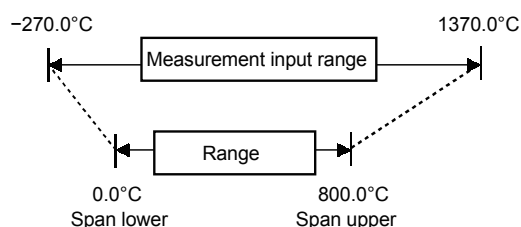

#### Range and Scale Settings for Voltage Input

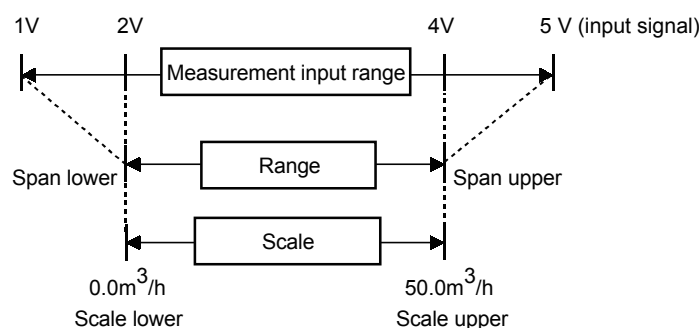

#### NOTE

If you change the PV range or scale, the control setpoint may be changed.

It affects the SP, PV range high and low limits, input switching PV high and low limits, remote bias, SP ramp-rate, high and low limit hystereses, and deviation display band.

In addition to the range and scale settings, you can set the control PV input range that determines the actual range of control.

Normally, the range and scale values are set.

However, if the range and scale settings exceeds 30000, the control PV input range is set within 30000 based on the lower limit.

The control PV input range is used particularly during loop control with PV switching.

## External PV (EXPV)

In place of the analog input of the PID control module itself, an external input channel (input, math, communication) is used for the PV input. The setting range is set to the control PV input range setting range.

## Calibration Correction Function

### Bias Function

Bias is a function that adds a bias to the PV input and uses the result in the controller display and control. This function is used to finely adjust the values when the values are within the accepted accuracy range but deviate from those of other devices.

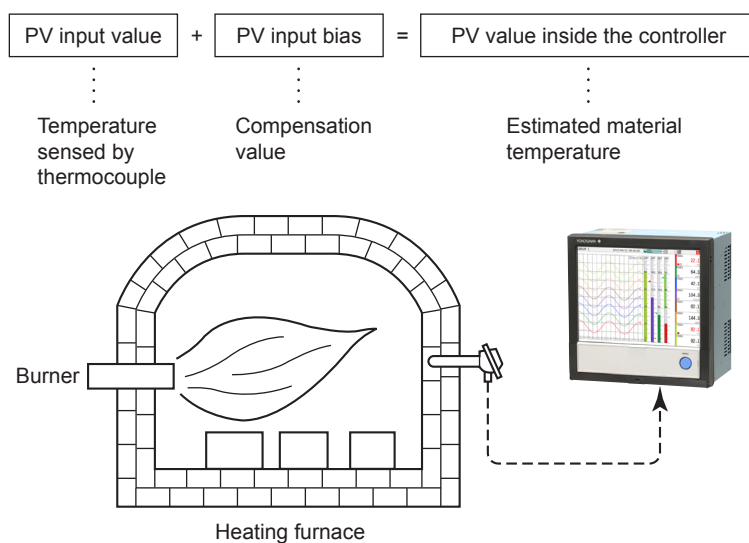

## Filter Function

If the PV input reading fluctuates greatly and the lower digits are difficult to read, a digital filter can be inserted as a buffer. This filter provides a first-order lag calculation, which can remove more noise as the time constant becomes larger. But, making the time constant too large will distort the waveform.

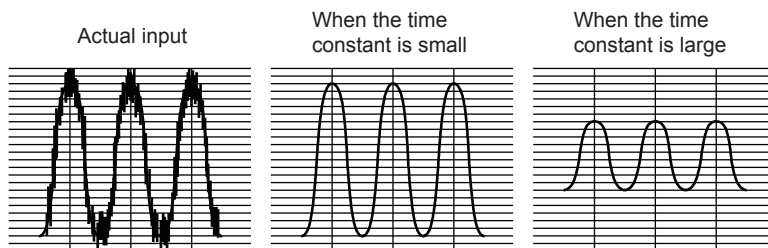
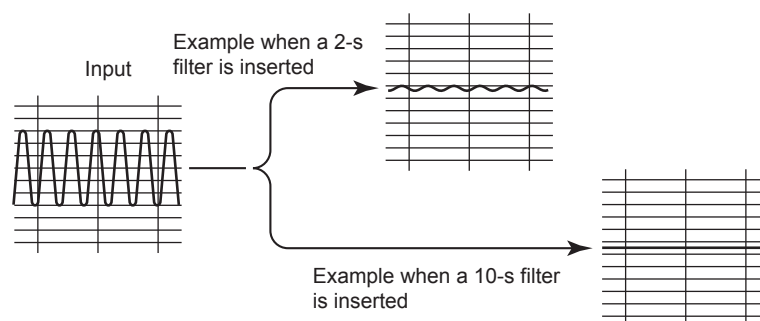

Illustration of the filter effect



## Linearizer Approximation, Linearizer Bias, and Correction Factor\*

Linearizer approximation is used when the input signal and the required measurement signal have a non-linear relationship, for example, when trying to obtain the volume from a sphere tank level.

Linearizer bias is used to correct an input signal affected by sensor deterioration.

The correction factor is used to set a correction value on the device side and a correction value on the sensor side and manage them.

\* On models with the /AH option

## Remote Input (RSP)

In place of the analog input of the PID control module itself, an external input channel (input, math, communication) is used for the remote input (RSP).

## Ratio Bias

Ratio bias computing performs ratio computation and bias addition for remote input.

## Digital Input

A single PID control module has eight contact inputs. It can be used to switch stop/run, auto/manual, and other operation modes as well as switch setpoint numbers, and switch program pattern numbers.

## 1.6 Output Function

### Control Output

Control output (OUT) is a universal output. You can set the type of output to current pulse or voltage pulse.

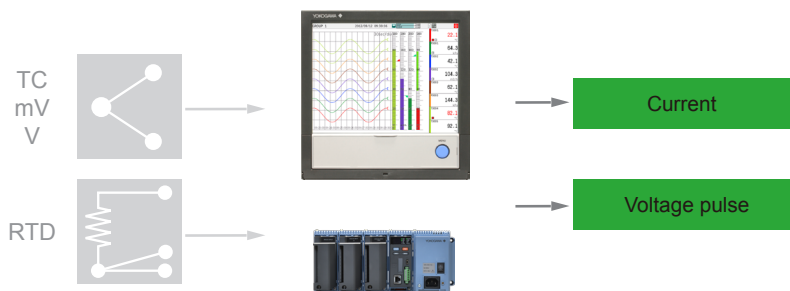

### Control Output Suppression

#### Control Output Limiter

Control output limiter can be used to set high and low limits on the control output operation range, regardless of the operation mode. Up to eight sets can be set in association with the PID parameters.

#### Output Velocity Limiter

Output velocity limiter prevents the control output signal from changing suddenly.

#### Preset Output

Preset output transmits a preset output value for the control output when the operation mode is changed from the operating state to the stopped state. The value can be set in the range of -5.0 to 105.0%.

#### Input Error Preset Output

Input error preset output transmits a preset output value or 0% or 100% for the control output when an input burnout, A/D conversion error, or the like occurs.

#### Tight Shut Output

Tight shut output fully closes the control valve (output is zero for 4 to 20 mA current output) beyond its positioner dead band. However, in auto mode, the output low limit is set to -5.0%, and the output does not fall to 0.0 mA. In manual mode, tight shut output (approx. 0.0 mA) is achieved.



## Retransmission Output (Analog Retransmission)

Retransmission output transmits PV, SP, control output (OUT), and the like externally using analog signals.

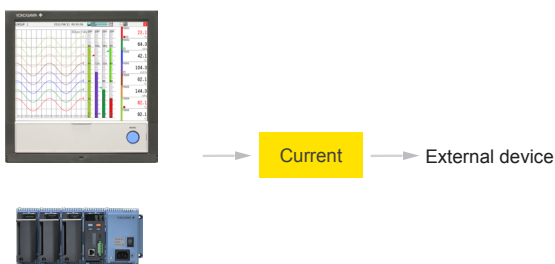

## 15 V DC Loop Power Supply

When the 15 V DC loop power supply is not used for control output or retransmission output, it can be used to supply 15 V DC to 2-wire type transmitters.

## Digital Output

A single PID control module has eight contact outputs. They are used for alarm output and status output.

# 1.7 Alarm Function

## Alarm Types

There are 11 control alarm types. The alarm operation varies depending on the contact action (energize or de-energize).

Alarm type	Alarm action (energize)	Alarm action (De-energize)
PV high		
PV low		
SP high limit		
SP low limit		
Deviation high limit		
Deviation low limit		
Deviation H/L limits		
Deviation within H/L limits		
Control output high limit		
Control output low limit		

\* "O" and "C" indicate the relay contact open and close states.

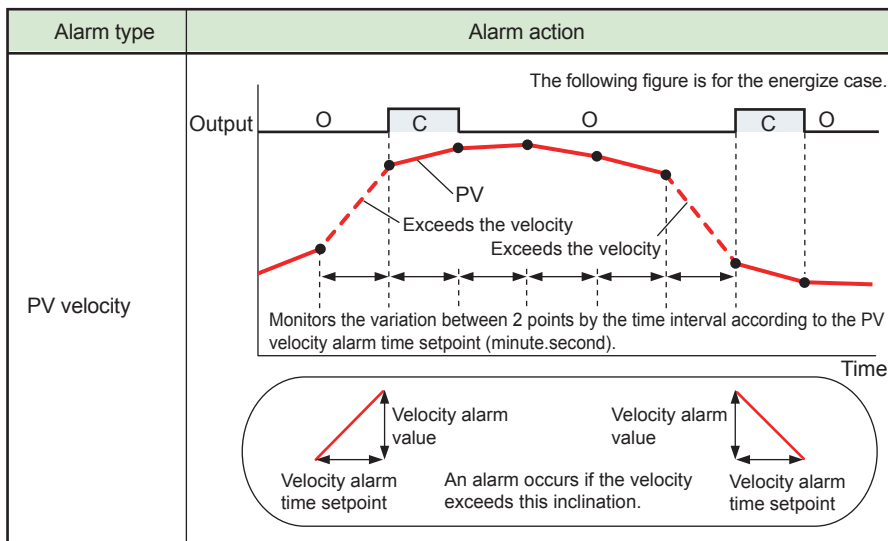

\* "O" and "C" indicate the relay contact open and close states.

## Number of Alarm Setpoints

Number of alarm setpoints: 4 per loop

## Alarm Hysteresis

If the alarm output repeatedly turns on and off drastically, you can reduce the intensity by increasing the alarm hysteresis.

## Standby Action

Standby action disables alarms until the first time the alarm condition ceases.

Standby action works in the following situations.

- At power-on
- When the SP is changed (in local mode)
- When the SP number is changed (in local mode) (The SP must change.)
- When the alarm type is changed

The following figure shows an example at power-on.

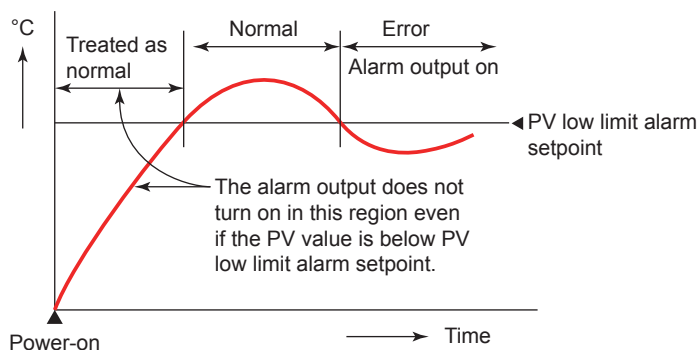

## Alarm Mode

You can also select the alarm output operating conditions from the following three types.

- Alarm enabled at all times
- Alarm disabled when operation is stopped (STOP)
- Alarm disabled in manual mode (MAN) or when operation is stopped (STOP)

## Alarm Delay Timer

Alarm-on delay timer starts a timer when an alarm condition occurs and turns on the alarm when the timer expires.

Alarm-off delay timer starts a timer when the alarm condition clears (returns to normal condition) and turns off the alarm when the timer expires.

If a value enters an area in which alarms do not occur when the timer is running, the timer is reset. Alarms will not occur.

## Alarm ACK (Latch Function Release)

The alarm acknowledge (alarm ACK) operation releases all alarm indications and relay outputs.

## Alarm Action during Program Control (/PG option)

Alarms can be set on PV, SP, and control output in addition to program settings when performing program control.

## 1.8 Action Function (Contact Input Switch Function)

The action function (contact input switch function) switches auto/manual, stop/run, and other operation modes using contact input, contact output, control alarm levels, or control alarm level states.

A single PID control module has eight digital inputs (DI1 to DI8), eight digital outputs (DO1 to DO8), four control alarm levels<sup>1</sup> (1 to 4), and four control alarm level states<sup>2</sup> (1 to 4).

\*1: An alarm level indicates the alarm status regardless of the specified relay action. Relay action behaves in the same manner as nonhold.

\*2: An alarm level indicates the alarm status including the specified relay action.

### Switching Functions That Used as Actions

The settings with ✓ marks in the table below are possible.

Event	Rising or falling edge	Trigger
AUTO/MAN switch	✓	
REMOTE/LOCAL switch	✓	
STOP/RUN switch	✓	
Switch to cascade		✓
Switch to AUTO		✓
Switch to MAN		✓
Switch to REMOTE		✓
Switch to LOCAL		✓
Auto-tuning START/STOP Switch	✓	
Alarm ACK		✓
Bit-0 to 3 of SP Number		✓
Bit-0 to 3 of PID Number		✓
PV switching	✓	

Action	Description
Rising edge (when the contact action is set to energize)	The action is executed when the event changes from off to on.
Falling edge (when the contact action is set to energize)	The action is executed when the event changes from on to off.
Trigger (detected on a ON signal lasting longer than the control period)	The action is executed when an event occurs.

Rising edge  
(when the contact action is set to energize)

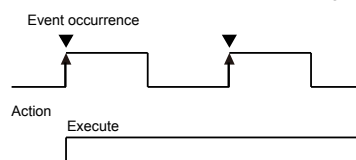

Falling edge  
(when the contact action is set to energize)

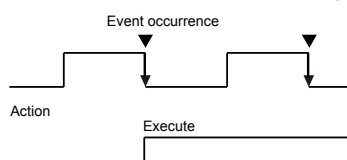

Trigger (detected on a ON signal lasting longer than the control period)

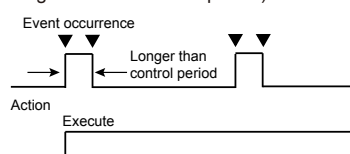

## 1.9 Control Event Action Function

The control event action function is used to execute a specified action when certain events occur.

For example, you can use the control event action function to do the following:

Example 1. Start running when the remote control input (DI channel) turns on.

Example 2. Change the operation mode to manual when a control alarm occurs.

Functions that can be used as control event actions are shown below.

### Control Operation

#### Loop Control and Common Control

Function	Description
Run all control loops	Starts running all loops when the input changes from off to on.
Stop all control loops	Stops all loops when the input changes from off to on.
Control operation start/stop (specified loop)	Starts the control operation of specified loops when the input changes from off to on. Stops the control operation of specified loops when the input changes from on to off.
Auto/manual switch (specified loop)	Switches the control operation of specified loops to auto when the input changes from off to on. Switches the control operation of specified loops to manual when the input changes from on to off.
Remote/local switch (specified loop)	Switches the control operation of specified loops to remote when the input changes from off to on. Switches the control operation of specified loops to local when the input changes from on to off.
Auto switch (specified loop)	Switches the control operation of specified loops to auto when the input changes from off to on.
Manual switch (specified loop)	Switches the control operation of specified loops to manual when the input changes from off to on.
Cascade switch (specified loop)	Switches the control operation of specified loops to cascade when the input changes from off to on (during cascade control).
Remote switch (specified loop)	Switches the control operation of specified loops to remote when the input changes from off to on.
Local switch (specified loop)	Switches the control operation of specified loops to local when the input changes from off to on.
SP number switch (binary/BCD)	Switches the SP number according to the combination of input ON/OFF states (binary or BCD).

## Program Control

Function	Description
Program RUN/RESET switch	Starts program operation when the input changes from off to on. Stops program operation when the input changes from on to off.
Hold operation	Pauses the operation of program patterns when the input changes from on to off.
Advance operation	Advances the operation of program patterns by one segment when the input changes from on to off.
Start of program operation	Starts program operation when the input changes from off to on.
Stop of program operation	Stops program operation when the input changes from off to on.
Hold operation (specified loop, specified program pattern)	Pauses the operation of the specified program pattern of the specified loop when the input changes from on to off.
Advance operation (specified loop, specified program pattern)	Advances the operation of the specified program pattern of the specified loop by one segment when the input changes from on to off.
Start of program operation (specified loop, specified program pattern)	Starts the operation of the specified program pattern of the specified loop when the input changes from on to off.
Stop of program operation (specified loop, specified program pattern)	Stops the operation of the specified program pattern of the specified loop when the input changes from on to off.
Program pattern number switch (binary/BCD selection)	Switches the program pattern number according to the combination of input ON/OFF states (binary or BCD).

## Notification and Monitoring

Control status monitoring parameters and notifications (events) are output to DO or internal switches (as actions).

Function	Description
Control status (RUN/STOP)	Outputs the control status (RUN status: ON, STOP status: OFF).
Wait end signal (1s, 3s, 5s)	Outputs an ON state signal for 1, 3, or 5 seconds when the program operation wait state ends.
Pattern end signal (1s, 3s, 5s)	Outputs an ON state signal for 1, 3, or 5 seconds when the program operation ends.
PV event status	Outputs an ON state signal while a PV event is occurring during program operation.
Time event status	Outputs an ON state signal while a time event is occurring during program operation.
Wait flag	Outputs an ON state signal while the program operation is waiting.
Hold-on flag	Outputs an ON state signal while the program operation is being held.
Program operation mode monitoring (STOP/RUN)	Outputs the program operation status (RUN: ON, STOP: OFF)
Segment number monitoring (binary/BCD)	Outputs the running segment number in binary or BCD ON/OFF states.
Pattern number monitoring (binary/BCD)	Outputs the running pattern number in binary or BCD ON/OFF states.

\* The behavior varies depending on the energize/de-energize state of the contact type.

# 1.10 Operation Screen

An operation screen for control is available in addition to the measurement and recording screen.

## Control Group Screen

The control group screen is used to monitor multiple loops simultaneously. There are two display formats: controller style in which values are emphasized as on a digital indicating controller and faceplate style in which control values are displayed using bar graphs.

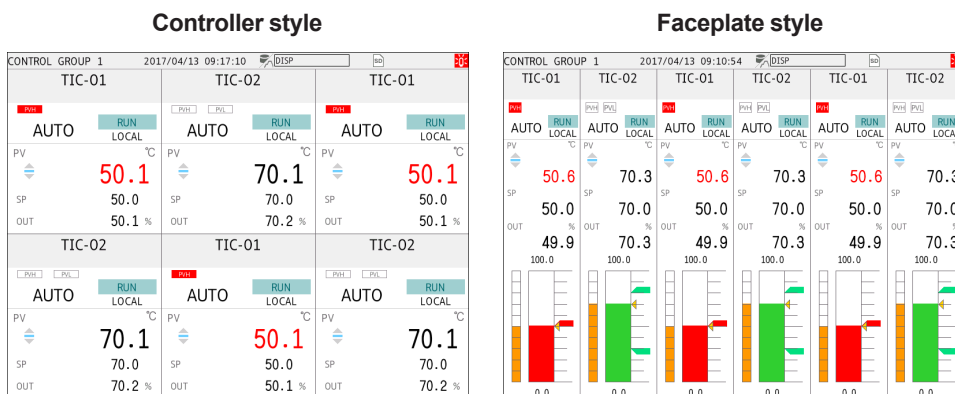

## Tuning Screen

The tuning screen is used to adjust PID constants and other control parameters.

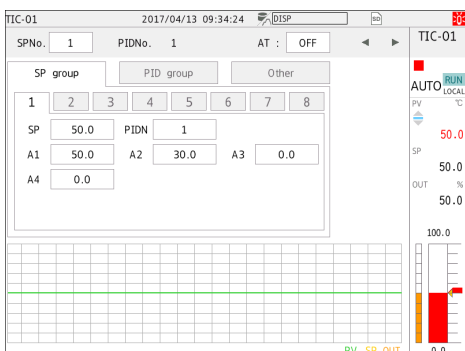

## Control Overview Screen

The control overview screen is used to monitor all loops collectively.

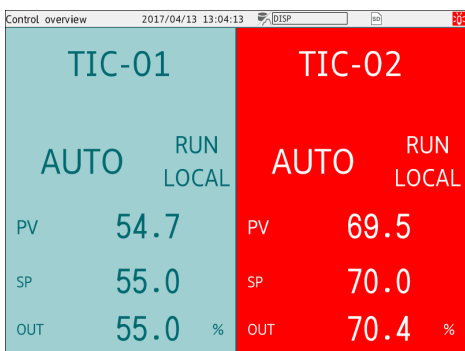



## Control Summary Screen

The control summary screen is used to display history of controls such as stop/run switching.

Control summary 2017/04/13 13:06:26 [DISP]			
UP	DOWN	Name	Time
		TIC-02	RUN 2017/04/13 13:06:17
		TIC-01	RUN 2017/04/13 13:06:14
		TIC-02	STOP 2017/04/13 13:06:04
		TIC-01	STOP 2017/04/13 13:05:56
		TIC-02	RUN 2017/04/13 12:51:47
		TIC-01	RUN 2017/04/13 12:51:43
		TIC-02	STOP 2017/04/13 12:51:36
		TIC-01	STOP 2017/04/13 12:51:36
		TIC-02	RUN 2017/04/13 12:49:34
		TIC-02	AUTO 2017/04/13 12:49:33
		TIC-01	RUN 2017/04/13 12:49:30

## Control Alarm Summary Screen

The control alarm summary screen is used to display history of control alarms.

Control alarm summary 2017/04/13 13:10:13 [DISP]					
UP	DOWN	Loop	Level	Type	Alarm time
▲		TIC-01	1	PVH	2017/04/13 13:09:43.230
▼		TIC-01	1	PVH	2017/04/13 13:09:21.430
▼		TIC-02	2	PVH	2017/04/13 13:08:53.430
▲		TIC-01	1	PVH	2017/04/13 13:08:25.130
▲		TIC-02	2	PVH	2017/04/13 13:03:10.830
▼		TIC-01	3	SPL	2017/04/13 13:02:31.430
▲		TIC-01	3	SPL	2017/04/13 13:02:06.930
▼		TIC-01	3	DVO	2017/04/13 13:01:32.830
▲		TIC-01	3	DVO	2017/04/13 13:01:26.730
▼		TIC-01	2	PVL	2017/04/13 12:50:46.730
▲		TIC-01	2	PVL	2017/04/13 12:50:28.030

## Multi Panel Screen (GX20/GP20 only)

The multi panel screen is used to collectively display screens with different display formats. It can be displayed along with measurement and recording screens.

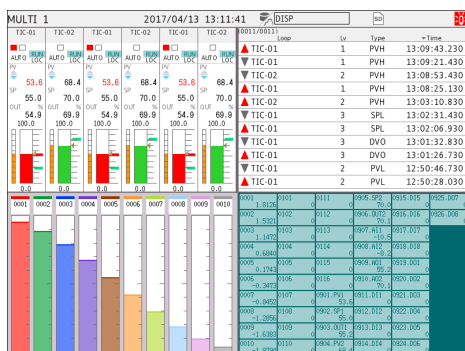

## Program Operation Screen

The program operation screen is used to display the program pattern that is currently running.

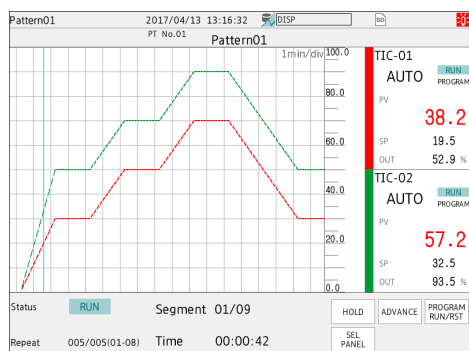

## Program Selection Screen

The program selection screen is used to select program patterns and view pattern settings.

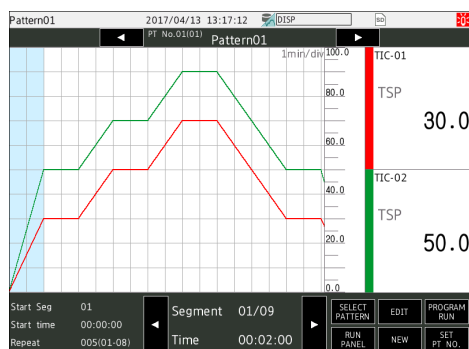

## Background Color

The background color of control screens can be set to white or black.

**White background**

TIC-01			TIC-02			TIC-01		
AUTO	RUN PROGRAM		AUTO	RUN PROGRAM		AUTO	RUN PROGRAM	
PV	54.1		PV	73.3		PV	54.1	
SP	30.0		SP	50.0		SP	30.0	
OUT	8.9 %		OUT	68.2 %		OUT	8.9 %	
TIC-02			TIC-01			TIC-02		
AUTO	RUN PROGRAM		AUTO	RUN PROGRAM		AUTO	RUN PROGRAM	
PV	73.3		PV	54.1		PV	73.3	
SP	50.0		SP	30.0		SP	50.0	
OUT	68.2 %		OUT	8.9 %		OUT	68.2 %	

**Black background**

TIC-01			TIC-02			TIC-01		
AUTO	RUN PROGRAM		AUTO	RUN PROGRAM		AUTO	RUN PROGRAM	
PV	53.3		PV	72.2		PV	53.3	
SP	28.7		SP	47.9		SP	28.7	
OUT	80.8 %		OUT	100.0 %		OUT	80.8 %	
TIC-02			TIC-01			TIC-02		
AUTO	RUN PROGRAM		AUTO	RUN PROGRAM		AUTO	RUN PROGRAM	
PV	72.2		PV	53.3		PV	72.2	
SP	47.9		SP	28.7		SP	47.9	
OUT	100.0 %		OUT	80.8 %		OUT	100.0 %	

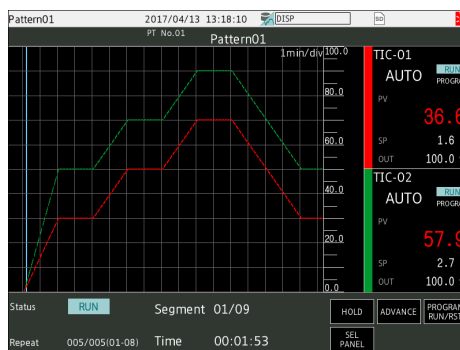
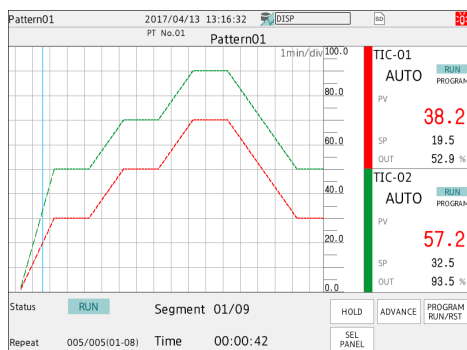

## Favorite and Standard Screens

Control screens can be registered to favorite and standard screens.



---

## SMARTDAC+ Universal Viewer (R3.01.01 or later)

This application can display and print data generated by GX/GP/GM main units.

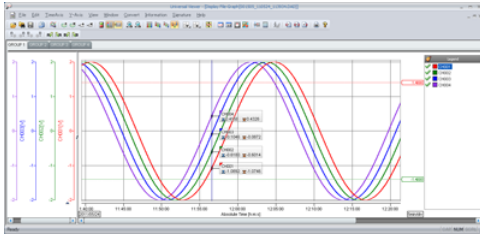

## DXA170 DAQStudio Custom Display (R5.02.01 or later)

DAQStudio is a software application used to create original monitor screens for displaying data measured on GX10/GX20/GP10/GP20 paperless recorders.

## GA10 Data Logging Software (R3.02.01 or later)

Data Logging Software GA10 is used to collect data from measuring instruments and controllers via communication and monitor and record the collected data. Recorded data can be displayed and printed from the Viewer software..

## 1.12 Web Application

The Web application can be used to control GX/GP/GM main units, configure main unit functions (except program patterns), and monitor data.

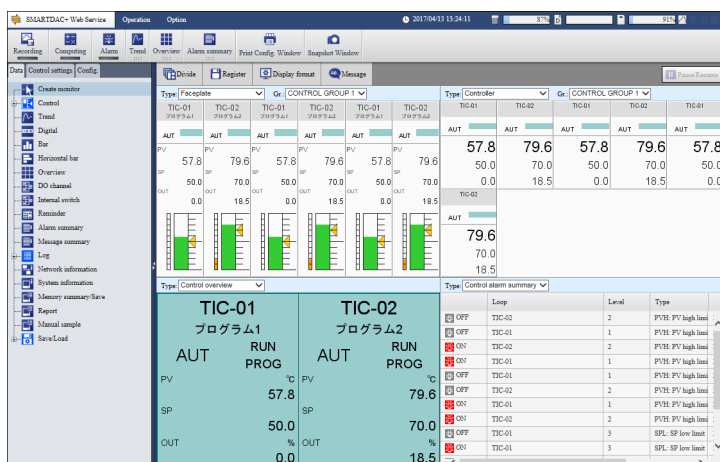

There is no need to install the Web application. The application screen appears when you specify the GX/GP/GM IP address on a Web browser.

### NOTE

If a GX/GP/GM is accessed from multiple browsers simultaneously, the Web application performance may degrade.

## 1.13 Control Data and I/O Data Acquisition/Recording Function

Control data refers to PV, SP, and control output (OUT). I/O data refers to analog input (AI), analog output (AO), digital input (DI), and digital output (DO).

By installing a PID control module in a GX/GP/GM and reconfiguring the system, you can acquire/record control data and I/O Data with PID channels (26 channels/module).

### Control buttons on the GX/GP main unit

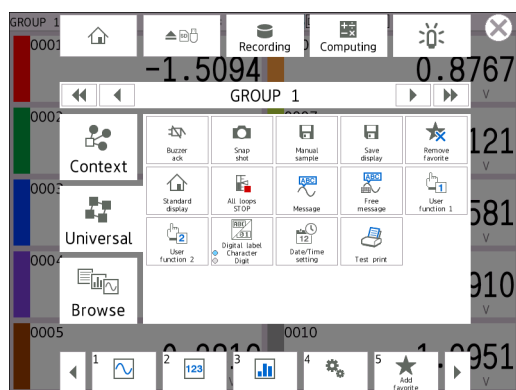

### Control buttons on the Web application

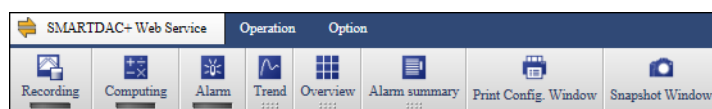

### Saving Data

Control data and I/O data made into channels are constantly saved in internal memory and can be transferred periodically to an external storage medium (SD card). Moreover, the FTP client function can be used to provide data redundancy using a file server. Data is saved without fail even in a sudden power interruption.

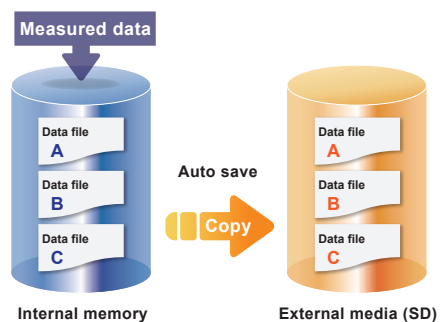

# 1.14 Screen Transitions

The following figure shows the transition between the operation screen for control and setting screen after the power is turned on.

Refer to this figure to configure and operate the system when using the PID control module.

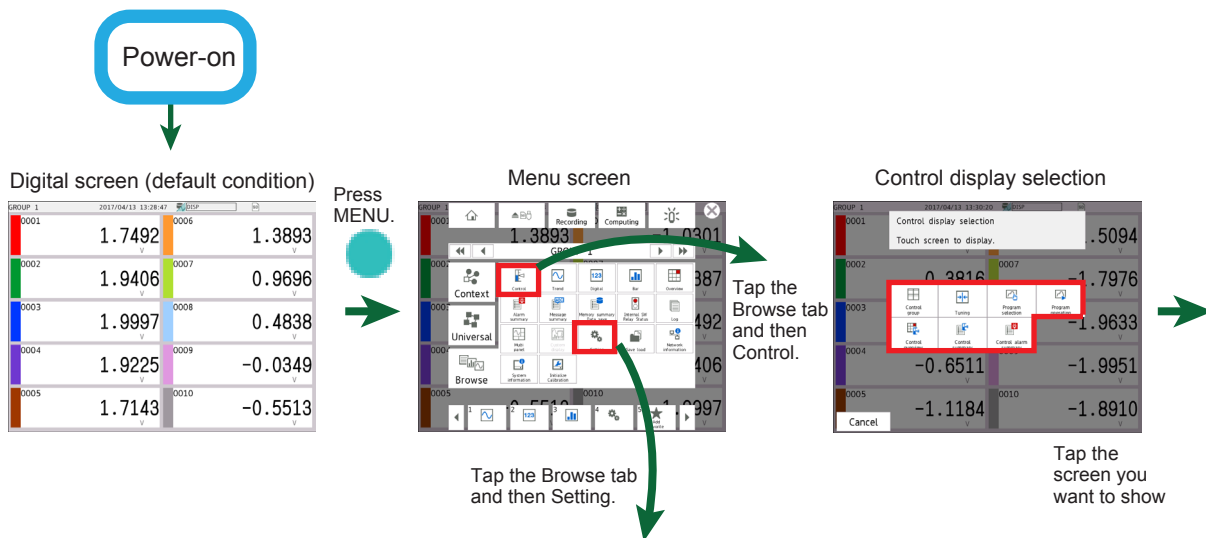

Set the basic action of loop control.

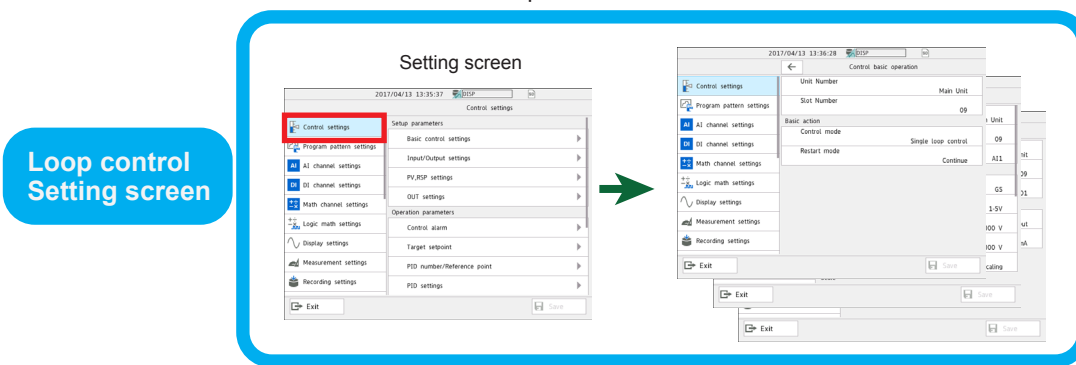

Perform program control

Create or edit a new program pattern. Set the program operation and the like.

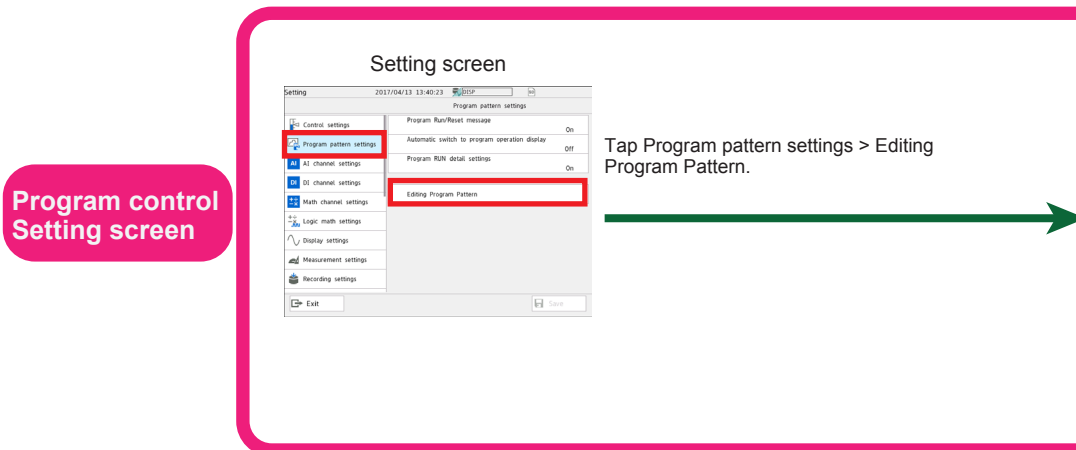



Operation screen

**Control group screen**

**Tuning screen**

**Control overview screen**

**Control summary**

**Control alarm summary**

Tap the Context tab and then Display to switch.

Program screen appears on models with the /PG option.

**Program selection screen**

**Program operation screen**

**Program selection screen (whole pattern display)**

**Program selection screen (program event display)**

**Program selection screen**

Tap NEW.

Tap EDIT.

Select a pattern number.

Edit the program pattern selected on the program selection screen.

**Program pattern setting screen**

## 1.15 Application Examples

### Component Firing in Electric Furnace or Industrial Furnace (GX10/ GX20, loop control)

Monitoring and turning control processes are easy.

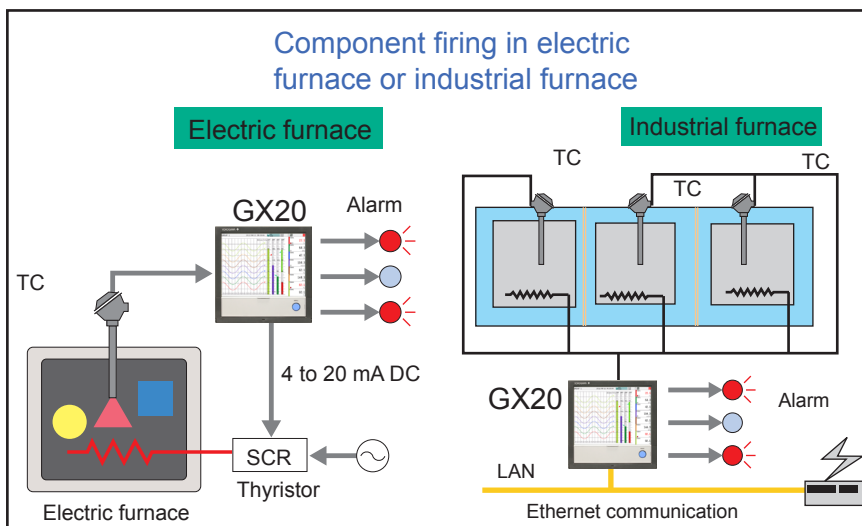

### Chemical Injection Control

Complicated computation is possible.

Injection ratio settings can be entered with actual values.

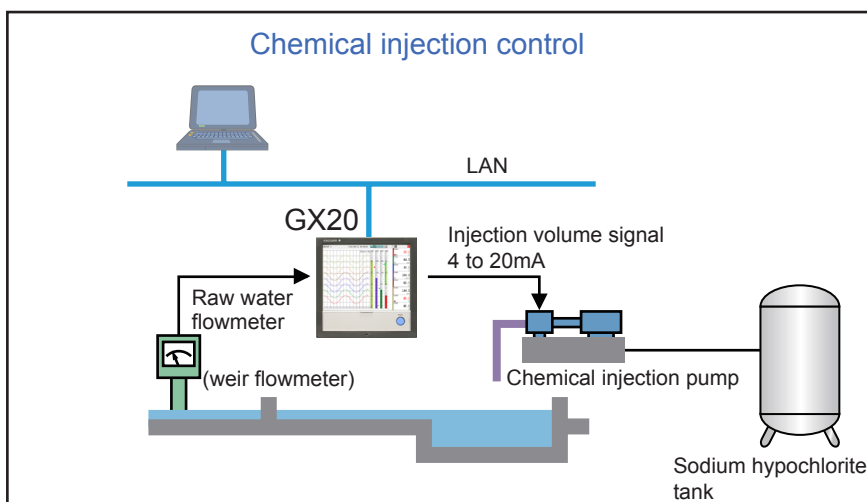

Injection volume of sodium hypochlorite is calculated based on the injection ratio, concentration, specific gravity in relation to the raw water flow rate. The injection volume setpoint is used to control or retransmit the setpoint to the pump.

$$\text{Injection flow rate (L/h)} = \frac{\text{Raw water flow rate (m}^3\text{/h)} \times \text{Injection ratio (mL/m}^3)}{\text{Specific gravity}} \times \frac{1}{1000} \times \frac{100}{\text{Concentration (\%)}}$$

## pH Control in Industrial Drain Facilities (GX10, loop control)

This system is best suited to controlling wide areas such as drain facilities of factories. Additional loops can be supported flexibly.

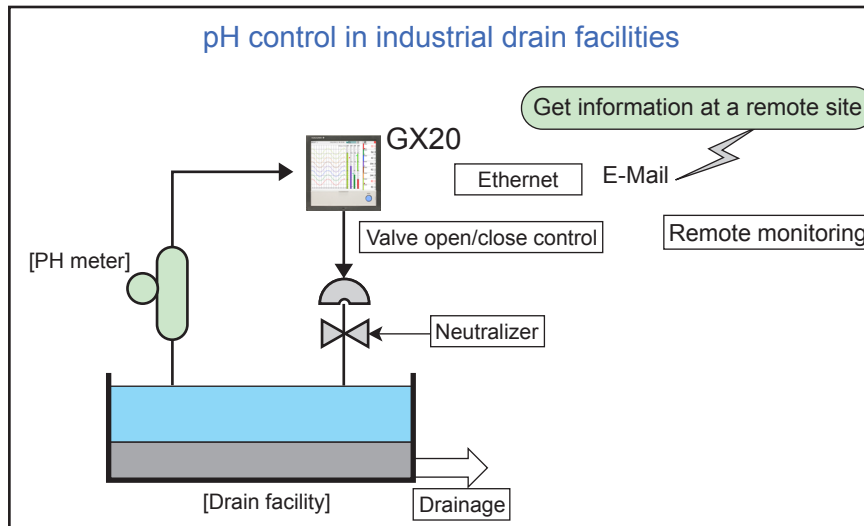

## Mesh Belt Type Continuous Furnace Control (GX20, loop control)

This system is best suited to the collective management of multiple loops. Module structure makes maintenance at the loop level easy.

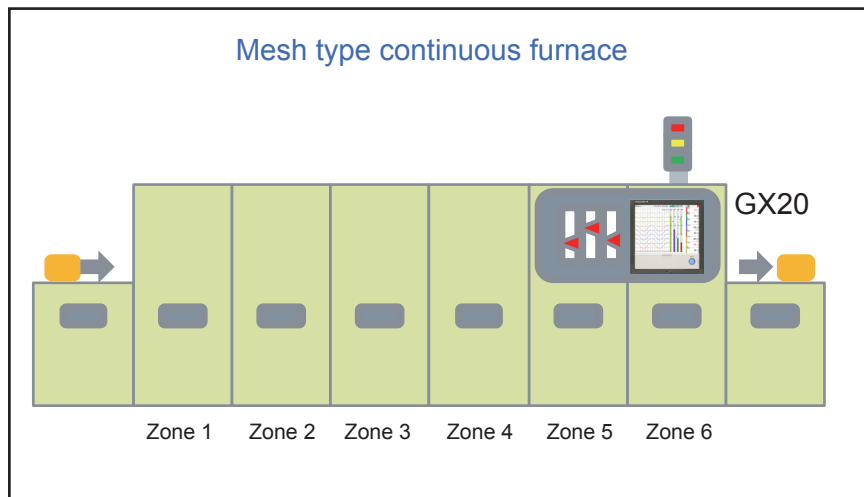

## Vertical Pit Furnace Control (GX10)

Synchronous program operation of multiple loops is possible.

This system best suited to controlling batch furnaces and other devices.

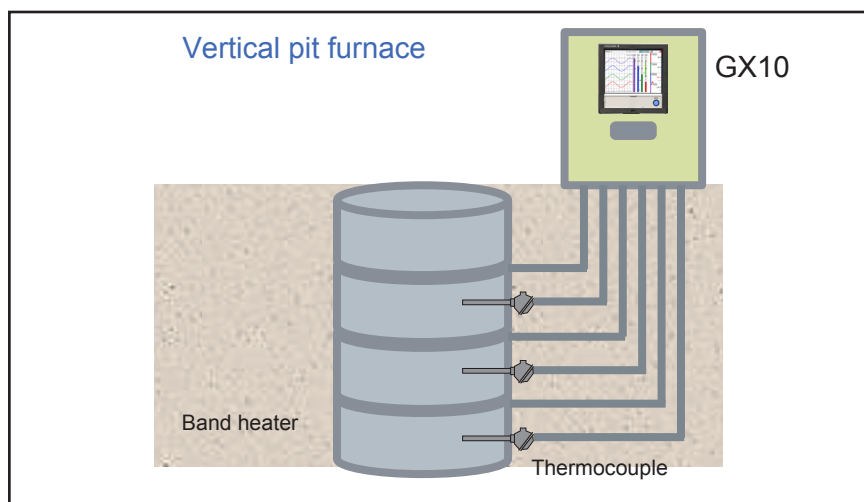

## Engine Durability Test Bench (GM10, source and measure synchronization)

Evaluation data can be measured while sourcing the test patterns.

Source and measurement synchronization is easy.

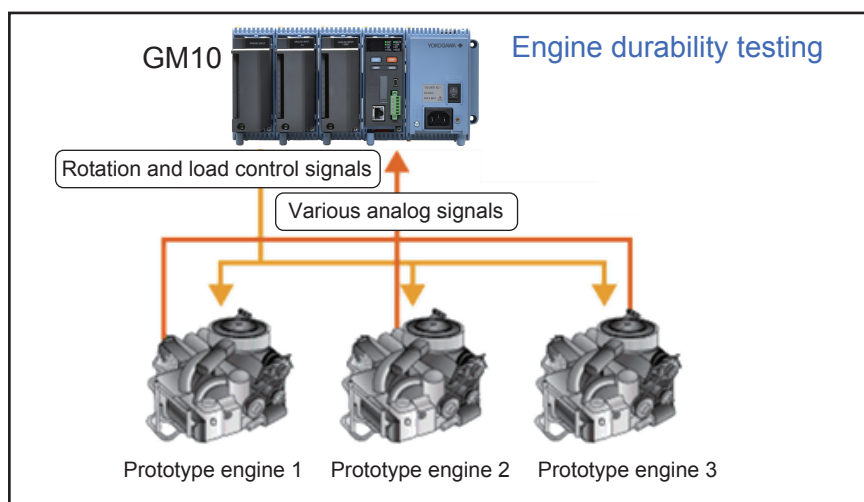

## Carburizing Furnace

Carbon potential (CP) control is possible.

Carbon potential (CP) monitoring and recording can be performed easily.

O<sub>2</sub> sensors (zirconia sensors) or CO<sub>2</sub> analyzers (infrared analyzers) can be used.

Multiple carbon potential (CP) computation is possible. (Simultaneous use of O<sub>2</sub> sensors and CO<sub>2</sub> analyzers is also possible. Best suited to management of accurate CP values.)

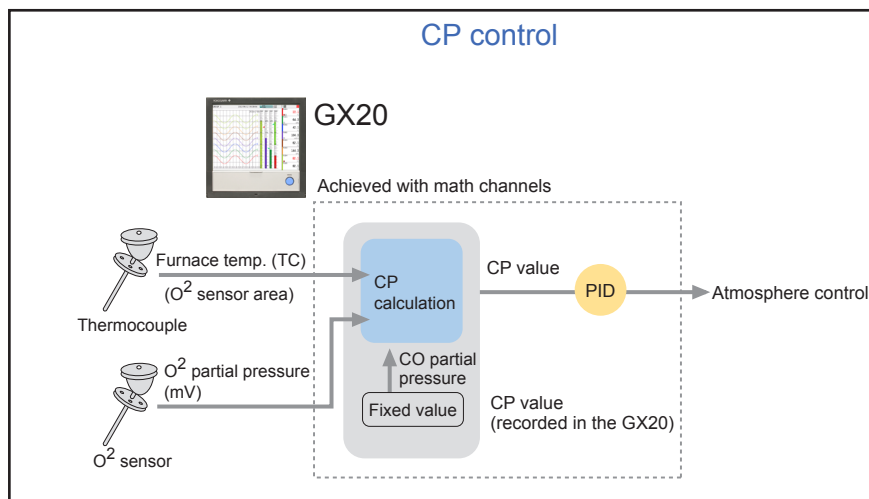

## 2. Using the Control Function for the First Time

### 2.1 Overview

This chapter briefly explains the settings and operating procedure as a first step to help you understand the functions when using the PID control module for the first time.

Explanations are given using the GX20 as an example. If you are using the GM, you can perform similar configurations and operations as on the GX20 using the Web application.

Before configuring, you need to reconfigure the PID control module (identify the module).

#### Application Example

The GX20 is used to perform temperature control on a furnace loop.

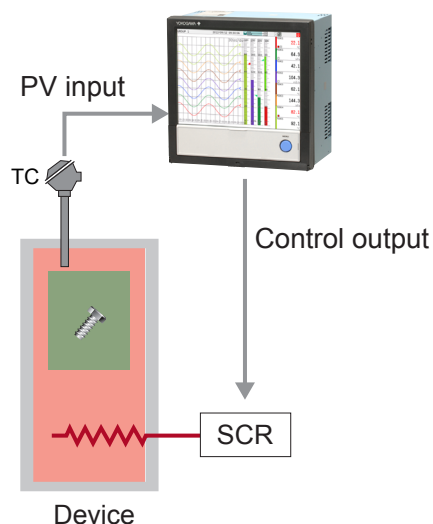

#### Instrument Configuration

GX20 main unit (1 unit)

A GX90UT PID control module installed in slot 9

#### Settings and Items to Check

Setup item		Value
Control mode		Single loop control (set on each module)
Control type		PID control
Measurement input range (AI number: AI1)	Type	TC
	Range	K
	Span lower	0.0°C
	Span upper	100.0°C
Output type (AO number: AO1)	Type	Current
	Current output range	4 to 20 mA
Target setpoint		SP number 1: 50.0°C
Control alarm	Type	Level 1: PV high limit, Level 2: PV low limit
	Alarm value	Level 1: 50.0°C, Level 2: 30.0°C

## 2.2 Initial Configuration

### STEP 1: Setting the control basic operation of the PID control module

Check that the control mode is set to single loop control (default value).

#### Procedure

- 1 Press MENU.  
The menu screen appears.

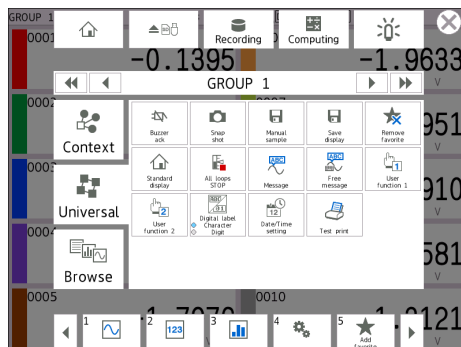

- 2 Tap the Browse tab and then Setting.  
The Setting screen appears.

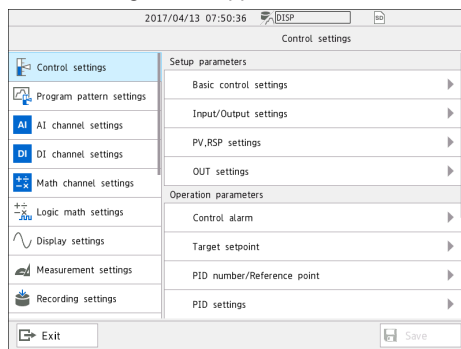

- 3 Tap Control settings > Basic control settings > Control basic operation.

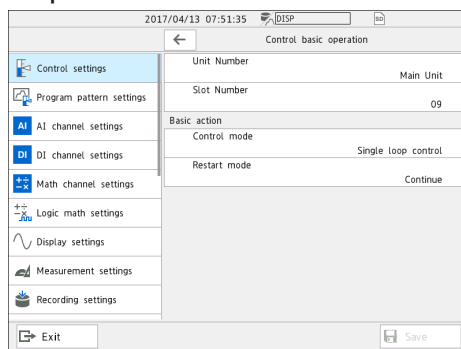





## STEP 2: Setting the loop's basic action

Check that the control type is set to PID control (default value).

### Procedure

- 1 Tap Control settings > Basic control settings > Control loop settings.

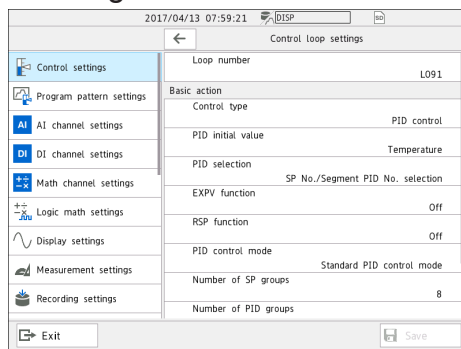

- 2 Check the control type.  
Control type: PID control

### Operation complete

To configure using the Web application, use the screen at the following path.

### Path

Web application: Browse tab > Setup parameters > Basic control settings > Control loop settings

Set the control type of loop number L091.

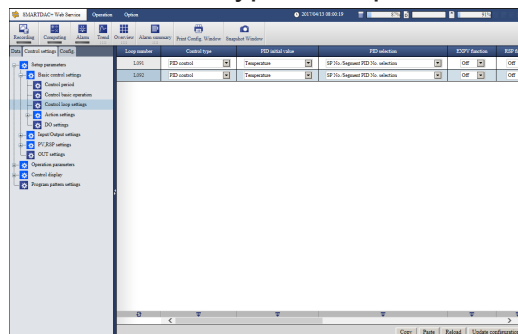

### STEP 3: Setting the PV input type, range, and span

Set the PV input type, range, and span.

#### Procedure

- 1 Tap Control settings > Input/Output settings > Measurement input range.

Field	Value
Unit Number	Main Unit
Slot Number	09
AI number	AI1
Range	Type: TC, Range: K
Span Lower	-270.0 °C
Span Upper	1370.0 °C
Calculation	Off

- 2 Check the unit number, slot number, and AI number. Then, set Type, Range, Span Lower, and Span Upper.

(AI number: AI1) Type: TC, Range: K, Span Lower: 0.0°C, Span Upper: 100.0°C

Field	Value
Unit Number	Main Unit
Slot Number	09
AI number	AI1
Range	Type: TC, Range: K
Span Lower	0.0 °C
Span Upper	100.0 °C
Calculation	Off

### Operation complete

To configure using the Web application, use the screen at the following path.

#### Path

Web application: Browse tab > Setup parameters > Input/Output settings > Measurement input range

Set the PV input type, range, and span of loop number L091.

AI number	Type	Range	Span Lower	Span Upper	Calculation	Decimal place	Lower
Main Unit (Module 9.101)	TC	K	0.0	100.0	Off		
Main Unit (Module 9.102)	TC	K	-270.0	1370.0	Off		

**STEP 4: Setting the control output type**

Check that the control output type is set to current (default value).

**Procedure**

- 1 Tap Control settings > Input/Output settings > Output type.

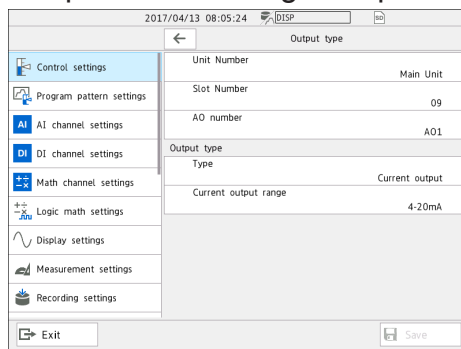

- 2 Check the unit number, slot number, AO number, type, and current output range.

Type: Current output, Current output range: 4-20mA

**Operation complete**

To configure using the Web application, use the screen at the following path.

**Path**

Web application: Browse tab > Setup parameters > Input/Output settings > Output settings > Output type

Set the control output type and current output range of loop number L091.

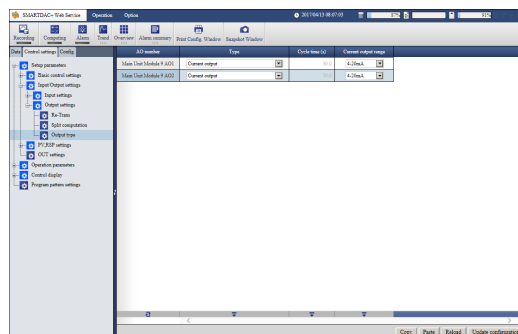

## STEP 5: Setting the target setpoint

Set the target setpoint.

### Procedure

#### 1 Tap Control settings > Target setpoint.

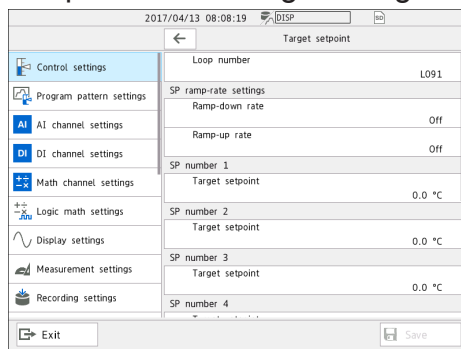

#### 2 Check the loop number, and set the target setpoint of SP number 1.

Main unit, slot number 9 (loop number: L091) SP number 1 target setpoint: 50.0°C

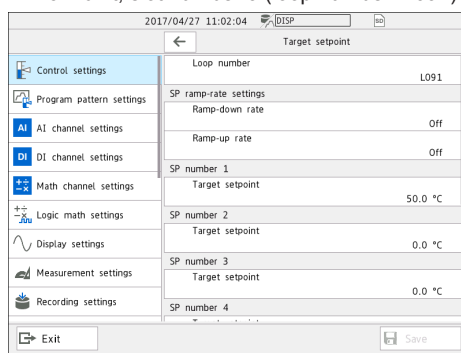

### Operation complete

To configure using the Web application, use the screen at the following path.

### Path

Web application: Browse tab > Operation parameters > Target setpoint

Set the target setpoint of loop number L091.

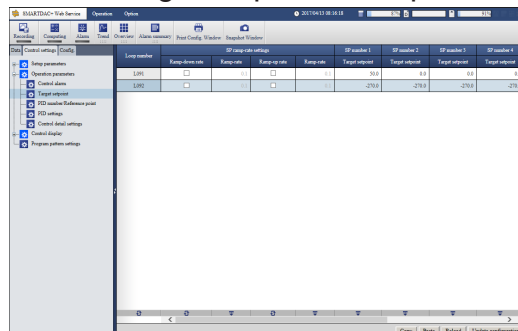

**STEP 6: Setting the control alarm types and setpoints**

Set the control alarm types and setpoints.

**Procedure****1** Tap Control settings > Control alarm.

Control settings	Control alarm
Control settings	Loop number L091
Program pattern settings	Level 1 On/Off Off
AI channel settings	Level 2 On/Off Off
DI channel settings	Level 3 On/Off Off
Math channel settings	Level 4 On/Off Off
Logic math settings	Value (L091)
Display settings	
Measurement settings	
Recording settings	

**2** Check the loop number, and set On/Off of Level 1 and Level 2 to On.

Loop 1, Level 1 type: PVH (PV high limit)

Loop 1, Level 2 type: PVL (PV low limit)

Control settings	Control alarm
Control settings	Loop number L091
Program pattern settings	Level 1 On/Off On
AI channel settings	Type PVH: PV high limit
DI channel settings	Stand-by action Off
Math channel settings	Hysteresis 0.0 °C
Logic math settings	On-delay timer (minutes) 0
Display settings	On-delay timer (seconds) 0
Measurement settings	Off-delay timer (minutes) 0
Recording settings	Off-delay timer (seconds) 0

**3** Tap Value (loop number), and set the alarm values.

Loop 1, Level 1 setpoint: 50.0°C

Loop 1, Level 2 setpoint: 30.0°C

Control settings	Value (L091)
Control settings	SP number 1
Program pattern settings	Alarm level 1 setpoint 50.0 °C
AI channel settings	Alarm level 2 setpoint 30.0 °C
DI channel settings	Alarm level 3 setpoint 0.0 °C
Math channel settings	Alarm level 4 setpoint 0.0 °C
Logic math settings	
Display settings	
Measurement settings	
Recording settings	

**Operation complete**



## 2.3 Monitoring and Controlling

### 2.3.1 Displaying the Monitoring Screen

#### Procedure

- 1 Press MENU.  
The menu screen appears.
- 2 Tap the Browse tab and then Control.  
The control display selection screen appears.

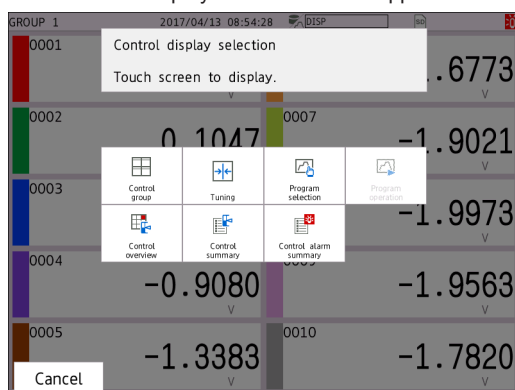

- 3 Tap Control group.

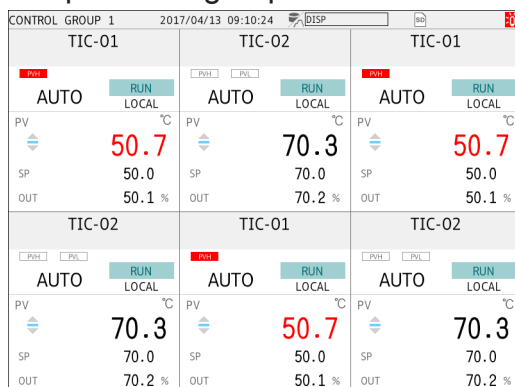

(Controller style)

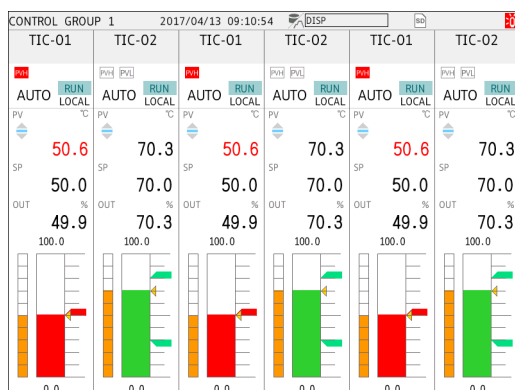

(Faceplate style)

To switch between controller style and faceplate style, press MENU and then tap Context > Display.

**Operation complete**

To monitor using the Web application, use the screen at the following path.

Path

Web application: Data tab > Controller or Faceplate

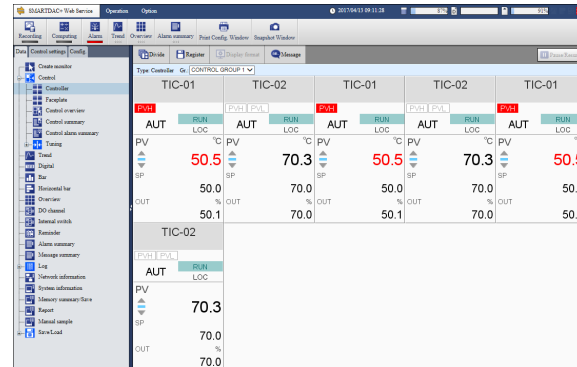

(Controller style)

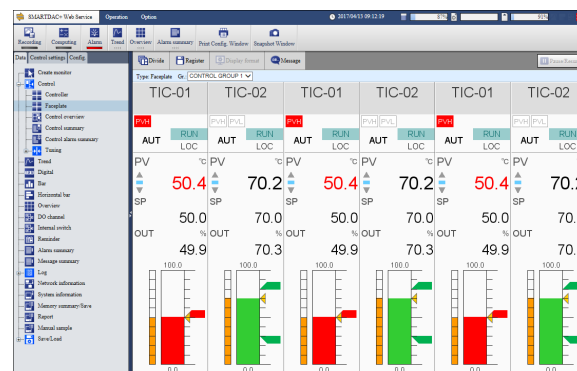

(Faceplate style)

The other available monitoring screens are control overview, control summary, control alarm summary.



## 2.3.2 Changing Target Setpoints

### Procedure

- 1 Display the control group screen.

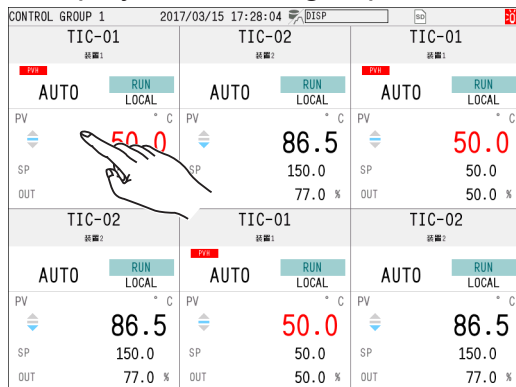

- 2 Tap the loop you want to change the target setpoint of. Here, tap Loop 1.  
The Loop operation screen appears.

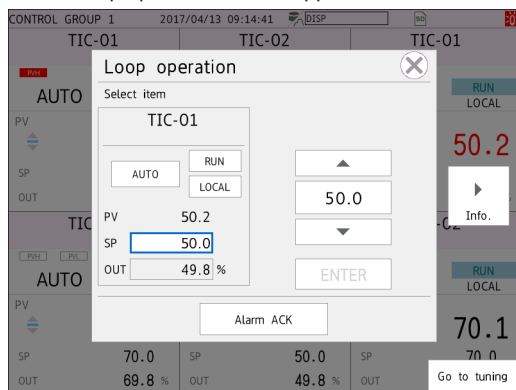

- 3 Tap the SP value to display parameter edit buttons.  
(The SP value can be tapped only in local mode.)
- 4 Tap ▲ or ▼ to change the value. To confirm the value, tap ENTER.  
(You can also enter the value directly from the keyboard by tapping the center value.)

Operation complete

To change a target setpoint using the Web application, use the screen at the following path.

### Path

Web application: Data tab > Faceplate or Controller

### Procedure

- 1 On the Faceplate or Controller screen, click the loop you want to change the target setpoint of. Here, click Loop 2. The Loop operation screen appears.

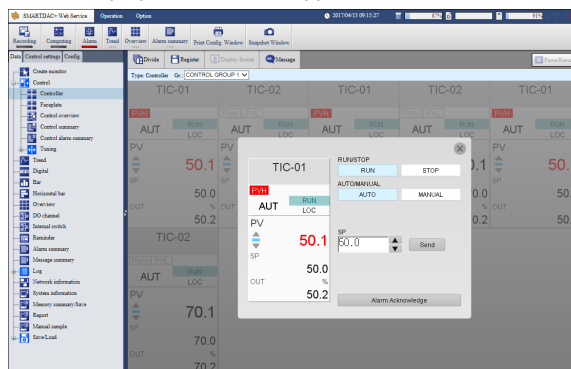

- 2 Click ▲ or ▼ to change the value, or enter the value directly from the keyboard, and click Send.

### Operation complete

## 2.3.3 Determining the Optimal PID with Auto-Tuning

### Procedure

- 1 Display the control group screen.

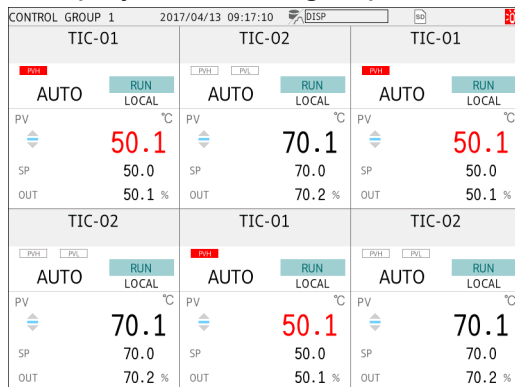

- 2 Press MENU.  
The menu screen appears.

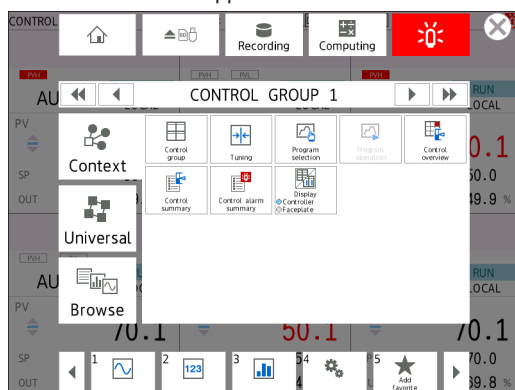

- 3 Tap the Context tab and then Tuning.  
A tuning screen appears.

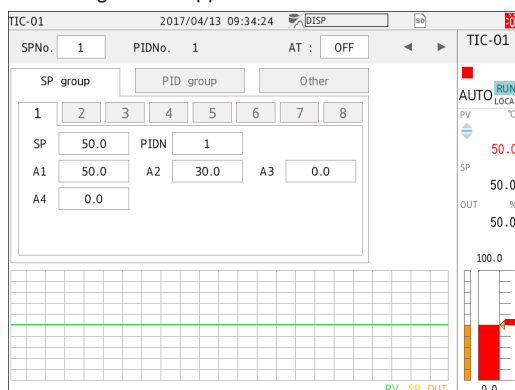

#### 4 Tap OFF displayed to the right of AT.

A caution message for using auto-tuning appears. Read the message, and tap the Close icon. AT cannot be executed in manual mode or when operation is stopped.

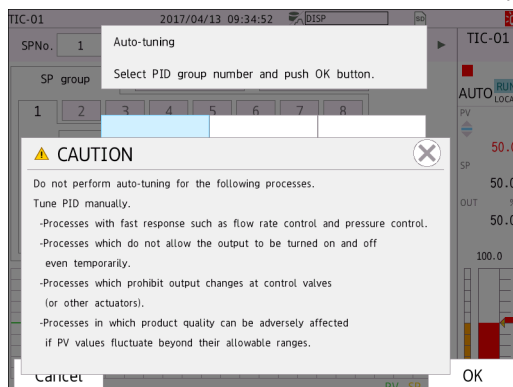

#### 5 Select PID group number 1, and tap OK.

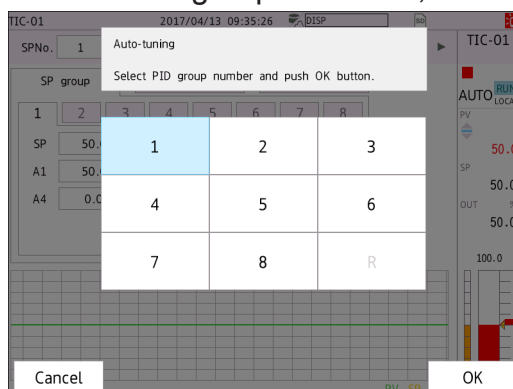

#### 6 While auto-tuning is in progress, AT in the loop area blinks.

### Operation complete

#### **Note**

- To execute auto-tuning, set the mode to AUTO and RUN.
- If the control mode is cascade control, execute auto-tuning on Loop 2 in AUTO and RUN modes and then Loop 1 in Cascade and RUN modes.
- If auto-tuning is executed on a loop running under program operation, the program operation is temporarily paused. The operation resumes when auto-tuning is complete.

To tune using the Web application, use the screen at the following path.

#### Path

Web application: Data tab > Control > Tuning > loop range (e.g., L001-L002)

#### Procedure

- 1 On the tuning screen, click AT:OFF.  
A caution screen for auto-tuning appears.

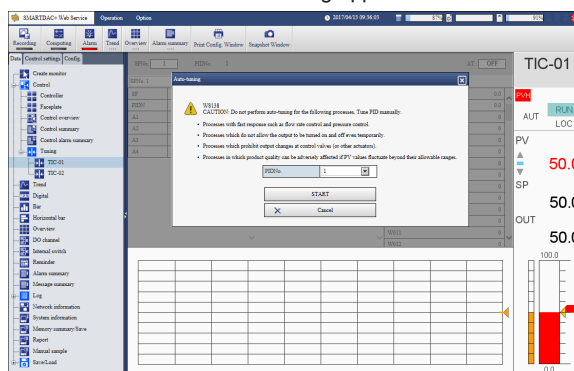

- 2 Set the PID number (PIDNo.) to store the tuning results in.
- 3 Click Start to execute auto-tuning.

Operation complete

## 2.3.4 Stopping and Running Operations

### Procedure

- 1 Display the control group screen.

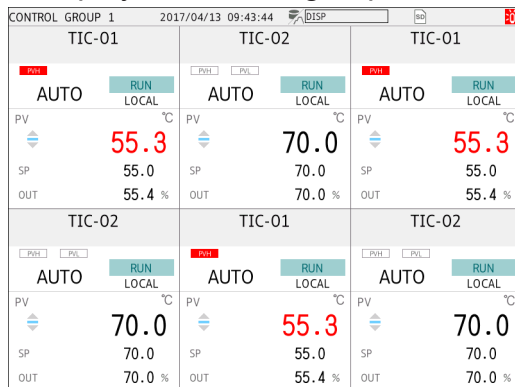

- 2 Tap the loop you want to switch the operation mode of. The Loop operation screen appears.

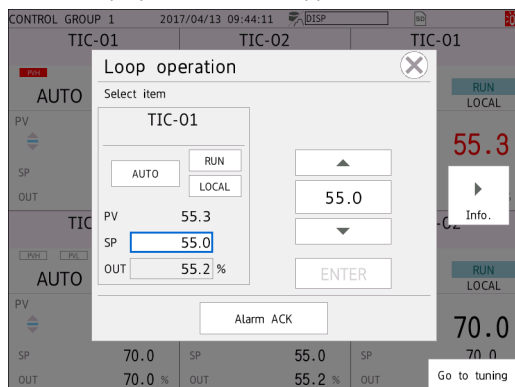

- 3 If the loop is running RUN is displayed. If the loop is stopped, STOP is displayed.
- 4 Tap RUN or STOP to display switch buttons on the right side of the screen. Tap a button to switch the operation mode.

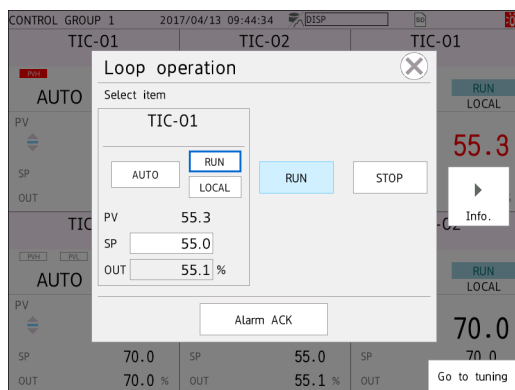

**Operation complete**

To switch the operation mode between run and stop using the Web application, use the screen at the following path.

**Path**

Web application: Data tab > Faceplate or Controller

**Procedure**

- 1 On the Faceplate or Controller screen, click the loop you want to switch the operation mode between run and stop. Here, click Loop 2.  
The Loop operation screen appears.

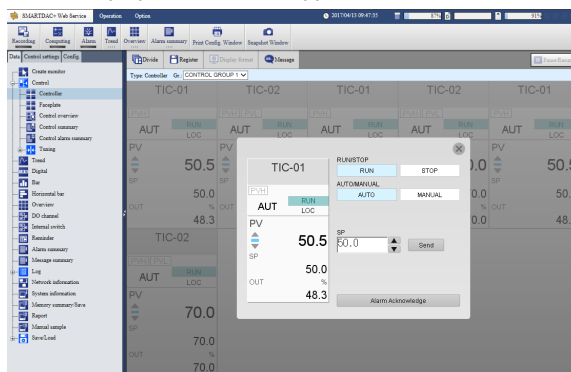

- 2 Click RUN or STOP to switch the operation mode.

**Operation complete**

## 2.3.5 Switching between Auto and Manual Modes

### Procedure

- 1 Display the control group screen.

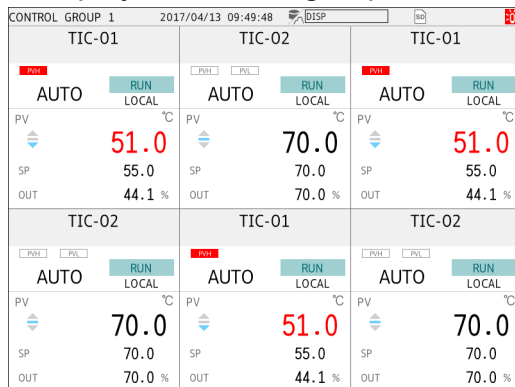

- 2 Tap the loop you want to switch the operation mode of. The Loop operation screen appears.

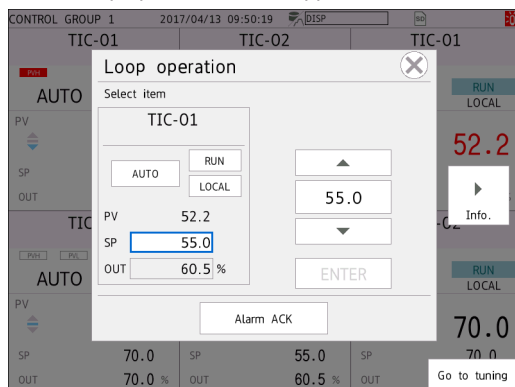

- 3 If the mode is auto, AUTO is displayed. If the mode is manual, MANUAL is displayed.
- 4 Tap AUTO or MANUAL to display switch buttons on the right side of the screen. Tap a button to switch the mode between auto and manual.

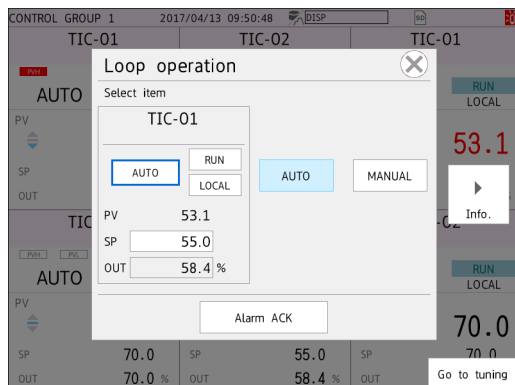

**Operation complete**



To switch the operation mode between auto and manual using the Web application, use the screen at the following path.

**Path**

Web application: Data tab > Faceplate or Controller

**Procedure**

- 1 On the Faceplate or Controller screen, click the loop you want to switch the operation mode between auto and manual. Here, click Loop 2.  
The Loop operation screen appears.

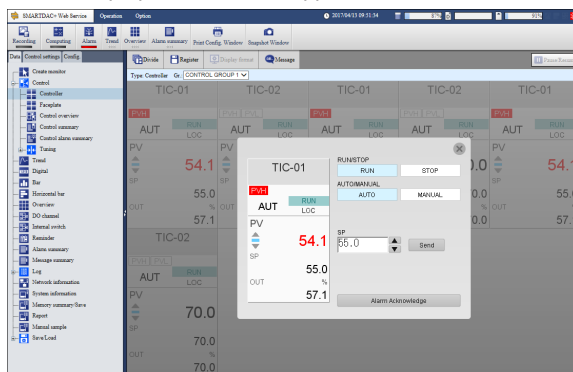

- 2 Click AUTO or MANUAL to switch the operation mode.

**Operation complete**

## 2.3.6 Controlling the Control Output in Manual Mode

### Procedure

- 1 Display the control group screen.

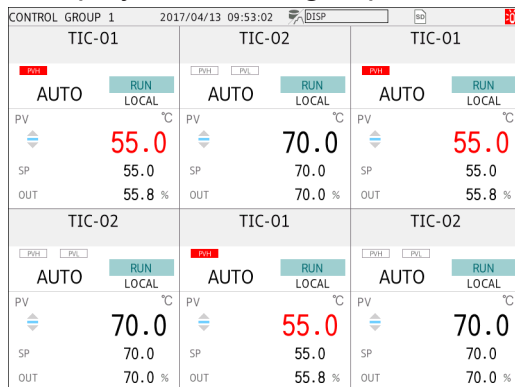

- 2 Tap the loop you want to switch the operation mode of. The Loop operation screen appears.
- 3 Tap the output value to display buttons for changing the value on the right side of the screen.
- 4 Tap ▲ or ▼ to change the value (direct input method). When you change the value, it is applied immediately to the process.

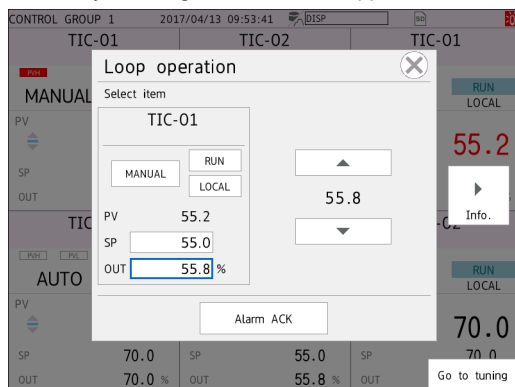

### Operation complete

### Description

There are two methods to change the control output value: the direct input method in which the value is changed continuously using the ▲ and ▼ buttons and the other method in which you confirm the changed value and bump the output using the ENTER button.

To change the control output value in manual mode using the Web application, use the screen at the following path.

### Path

Web application: Data tab > Faceplate or Controller

### Procedure

- 1 On the Faceplate or Controller screen, click the loop you want to change the control output value of. Here, click Loop 1. The Loop operation screen appears.

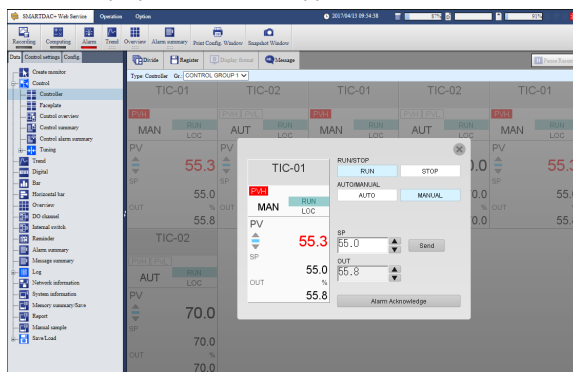

- 2 Click the output value and then the ▲ and ▼ buttons to change the value (direct input method). When you change the value, it is applied immediately to the process.

### Operation complete

### 3. Program Pattern Examples

This section explains how to set the program pattern shown in the following figure. The explanation is given only for Loop 1, but other loops can be set in the same way as well.

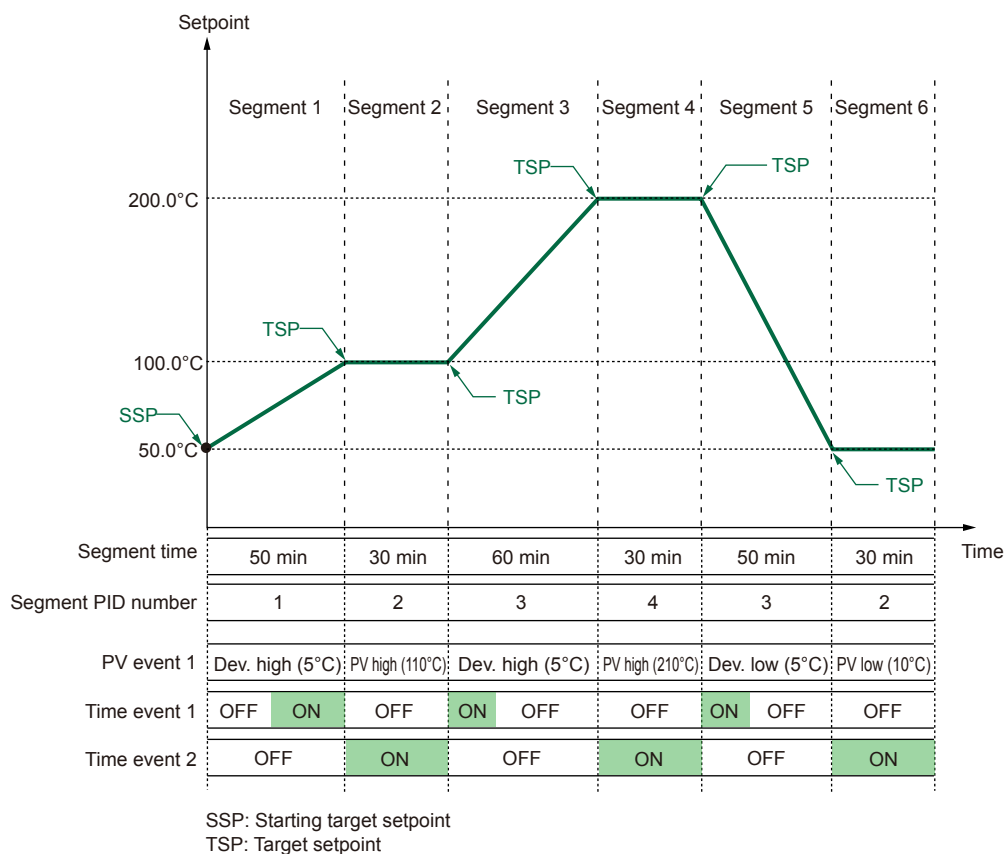

Set the target setpoint and segment time for segments 1 to 6 as follows:

- (1) The operation start temperature is 50.0°C. The temperature is increased to 100.0°C over 50 minutes.
- (2) When the temperature reaches 100.0°C, this temperature is maintained for 30 minutes.
- (3) The temperature is increased to 200.0°C over 60 minutes.
- (4) When the temperature reaches 200.0°C, this temperature is maintained for 30 minutes.
- (5) The temperature is decreased to 50.0°C over 50 minutes.
- (6) When the temperature reaches 50.0°C, this temperature is maintained for 30 minutes.

Segment PID number and junction code are set for each segment.

PV event and time event are set after setting the program pattern.

Before setting program pattern settings and program control settings, the following control settings must be configured. These are the control basic operation settings. For the setup procedure, see chapter 2.

### Control settings

We assume that the PID control module is installed in slot number 09 of the main unit.

Setup item	Settings menu	Value
Control mode	Control settings > Basic control settings > Control basic operation	Single loop control
PID type	Control settings > Basic control settings > Control loop settings	PID Control
PID selection	Control settings > Basic control settings > Control loop settings	SP No./Segment PID No. selection
Number of PID groups	Control settings > Basic control settings > Control loop settings	8
AI number	Control settings > Input/Output settings > Measurement input range	AI1
Type	Control settings > Input/Output settings > Measurement input range	TC
Range	Control settings > Input/Output settings > Measurement input range	K
Span Lower	Control settings > Input/Output settings > Measurement input range	0.0°C
Span Upper	Control settings > Input/Output settings > Measurement input range	200.0°C

Use the default values for settings other than those above.

### Procedure

#### 1 Press MENU.

The menu screen appears.

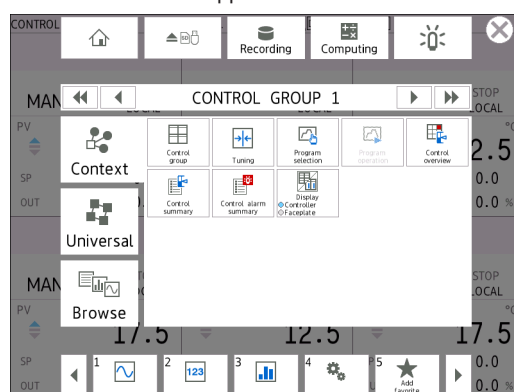

#### 2 Tap the Browse tab and then Setting.

The Setting screen appears.

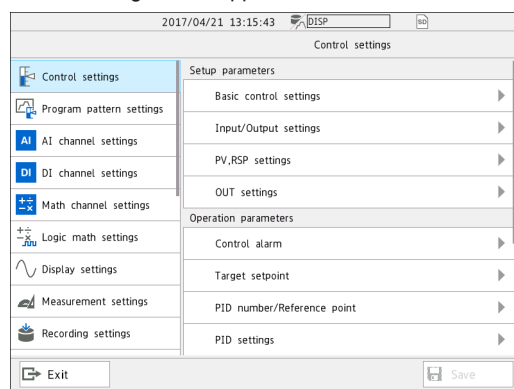

- 3** Tap Program pattern settings > Editing Program Pattern.  
A program pattern selection screen appears.

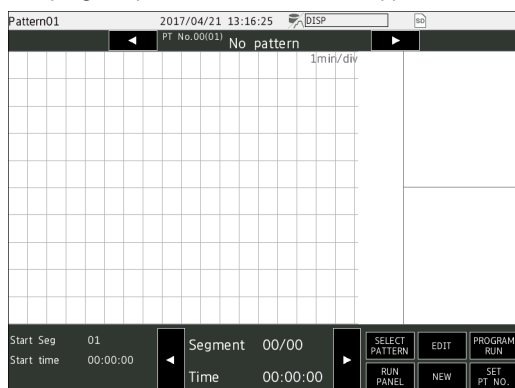

- 4** Tap NEW.

- 5** Select a pattern number, and tap OK.  
A program pattern setting screen appears.

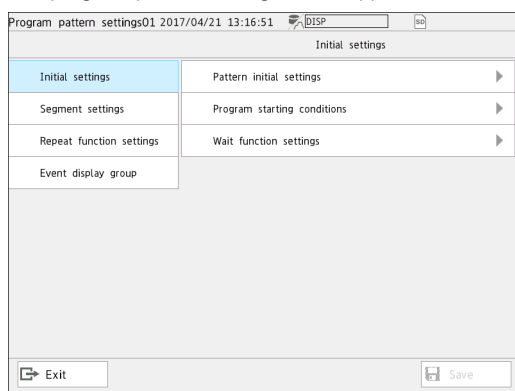

- 6** Tap Program setting menu Initial settings > Pattern initial settings.

Set the setup items according to the following table.

Setup item	Value
Pattern name	Sample program
Number of loops used	1
Action loop	L091 (main unit, slot 09, loop 1)

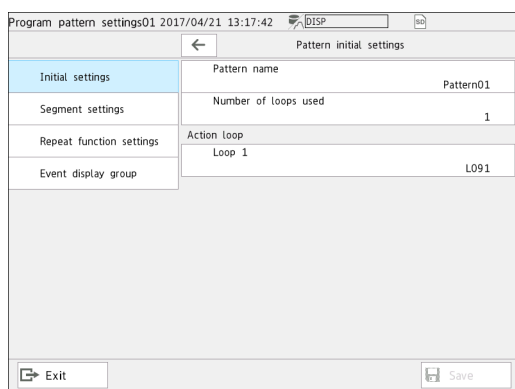

## 7 Tap Program setting menu Initial settings > Program starting conditions.

Set the setup items according to the following table.

Setup item	Settings menu	Value
Starting target setpoint	Initial settings > Program starting conditions	50.0°C
Start code	Initial settings > Program starting conditions	Starting target setpoint

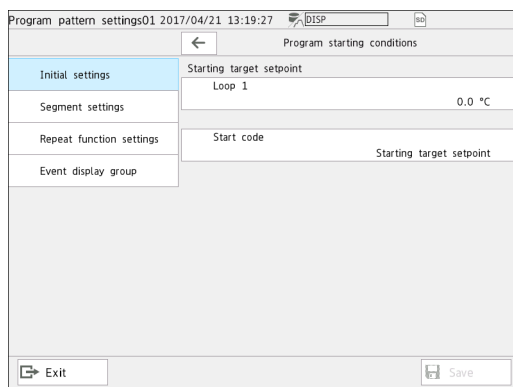

## 8 Tap Program setting menu Segment settings > Program pattern setting.

Set the setup items according to the following table.

Segment	Setup item	Value
1	Target setpoint	100.0°C
	Segment time	00:50:00
	Segment PID number selection	1
	Junction code	Switching for continuation
2	Target setpoint	100.0°C
	Segment time	00:30:00
	Segment PID number selection	2
	Junction code	Switching for continuation
3	Target setpoint	200.0°C
	Segment time	01:00:00
	Segment PID number selection	3
	Junction code	Switching for continuation
4	Target setpoint	200.0°C
	Segment time	00:30:00
	Segment PID number selection	4
	Junction code	Switching for continuation
5	Target setpoint	50.0°C
	Segment time	00:50:00
	Segment PID number selection	3
	Junction code	Switching for continuation
6	Target setpoint	50.0°C
	Segment time	00:30:00
	Segment PID number selection	2
	Junction code	Switching for continuation

## 9 Tap Program setting menu Segment settings > Time Event settings.

Set the setup items according to the following table.

Segment	Time event	Setup item	Value
1	Time event 1	Start Condition	OFF start
		On time	00:25:00
		Off time	00:00:00
	Time event 2	Start Condition	OFF start
		On time	00:00:00
		Off time	00:00:00
2	Time event 1	Start Condition	OFF start
		On time	00:00:00
		Off time	00:00:00
	Time event 2	Start Condition	ON start
		On time	00:00:00
		Off time	00:00:00
3	Time event 1	Start Condition	ON start
		On time	00:00:00
		Off time	00:20:00
	Time event 2	Start Condition	OFF start
		On time	00:00:00
		Off time	00:00:00



4	Time event 1	Start Condition	OFF start
		On time	00:00:00
		Off time	00:00:00
	Time event 2	Start Condition	ON start
		On time	00:00:00
		Off time	00:00:00
5	Time event 1	Start Condition	ON start
		On time	00:00:00
		Off time	00:20:00
	Time event 2	Start Condition	OFF start
		On time	00:00:00
		Off time	00:00:00
6	Time event 1	Start Condition	OFF start
		On time	00:00:00
		Off time	00:00:00
	Time event 2	Start Condition	ON start
		On time	00:00:00
		Off time	00:00:00

## 10 Tap Program setting menu Segment settings > PV Event settings.

Set the setup items according to the following table.

Segment	PV event	Setup item	Value
1	PV event 1	Loop number	Loop 1
		Type	DVH: Deviation high limit
		Value	5.0°C
2	PV event 1	Loop number	Loop 1
		Type	PVH: PV high limit
		Value	110.0°C
3	PV event 1	Loop number	Loop 1
		Type	DVH: Deviation high limit
		Value	5.0°C
4	PV event 1	Loop number	Loop 1
		Type	PVH: PV high limit
		Value	210.0°C

5	PV event 1	Loop number	Loop 1
		Type	DVL: Deviation low limit
		Value	-5.0°C
6	PV event 1	Loop number	Loop 1
		Type	PVL: PV low
		Value	10.0°C

**11** Tap Program setting menu Event display group.  
Set the setup items according to the following table.

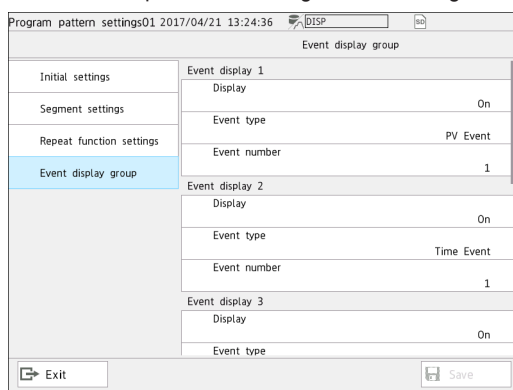

Event display	Setup item	Value
1	Display	On
	Event type	PV event
	Event number	1
2	Display	On
	Event type	Time event
	Event number	1
3	Display	On
	Event type	Time event
	Event number	2

Operation complete

---

# Technical Information

Name: SMARTDAC+ Loop Control Function, Program Control Function (/PG Option)

Number: TI 04L51B01-31EN

**May, 2017, 1<sup>st</sup> Edition**

---

■	Author	Yokogawa Electric Corporation
■	Issued by	Yokogawa Electric Corporation 180-8750 Tokyo, Musashino-shi, Nakamachi 2-9-32

---

